

# FLOOR PLANS





# Ground Floor



SECTION "A"    SECTION "B"



# 2 Floor



SECTION "A"    SECTION "B"



# 3 Floor



SECTION "A"    SECTION "B"

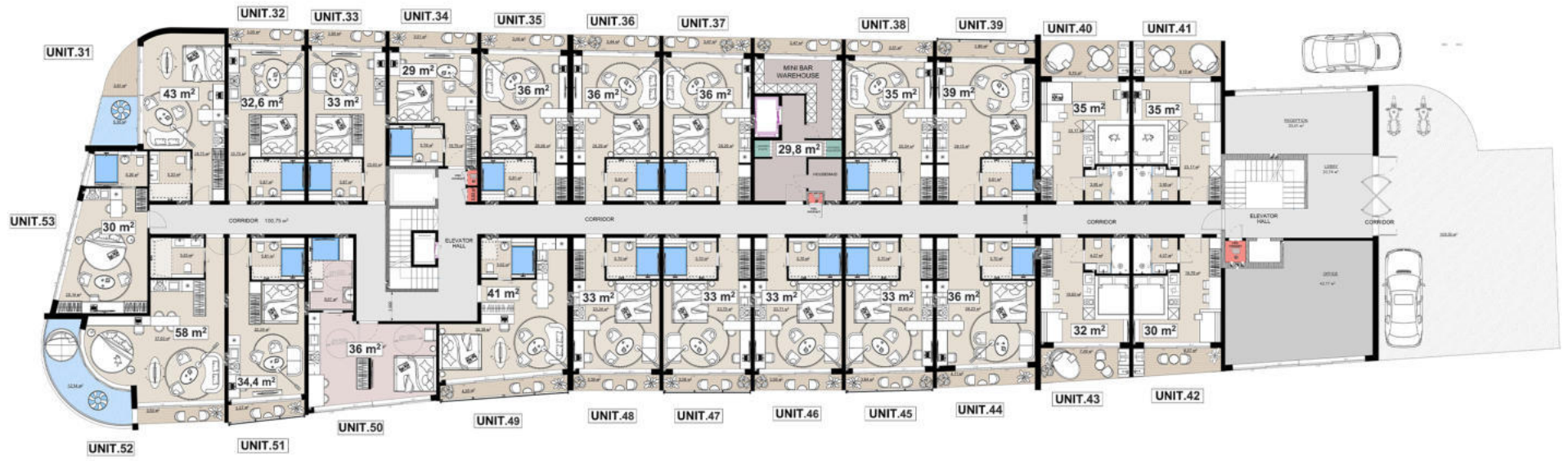

# 4 Floor



SECTION "A" SECTION "B"



# 5 Floor



SECTION "A" SECTION "B"



# Roof Top

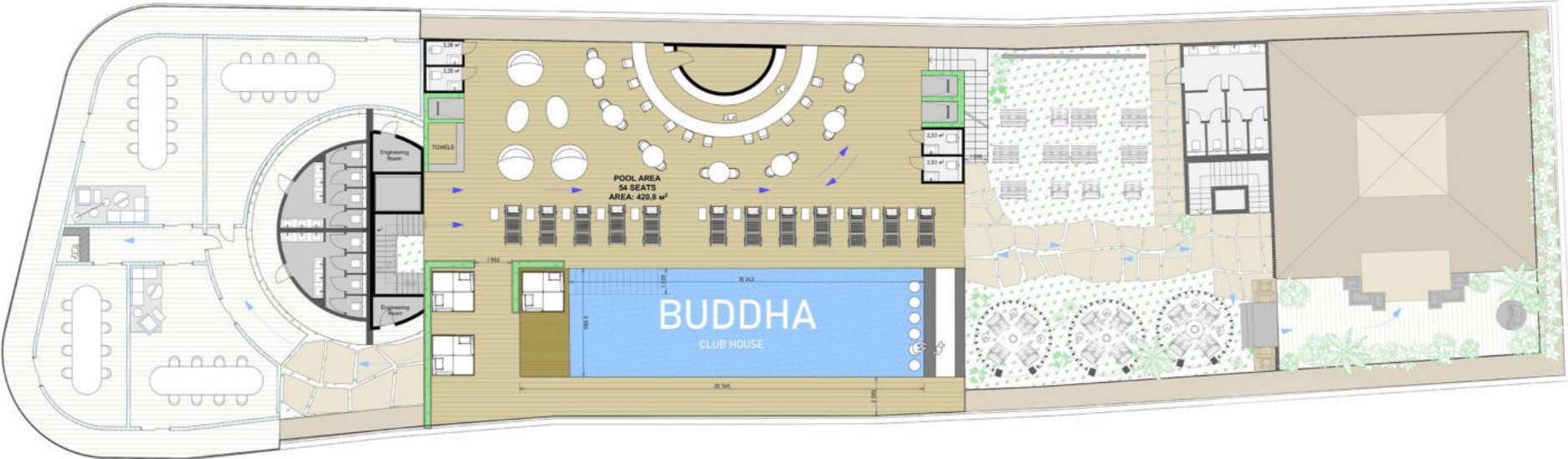

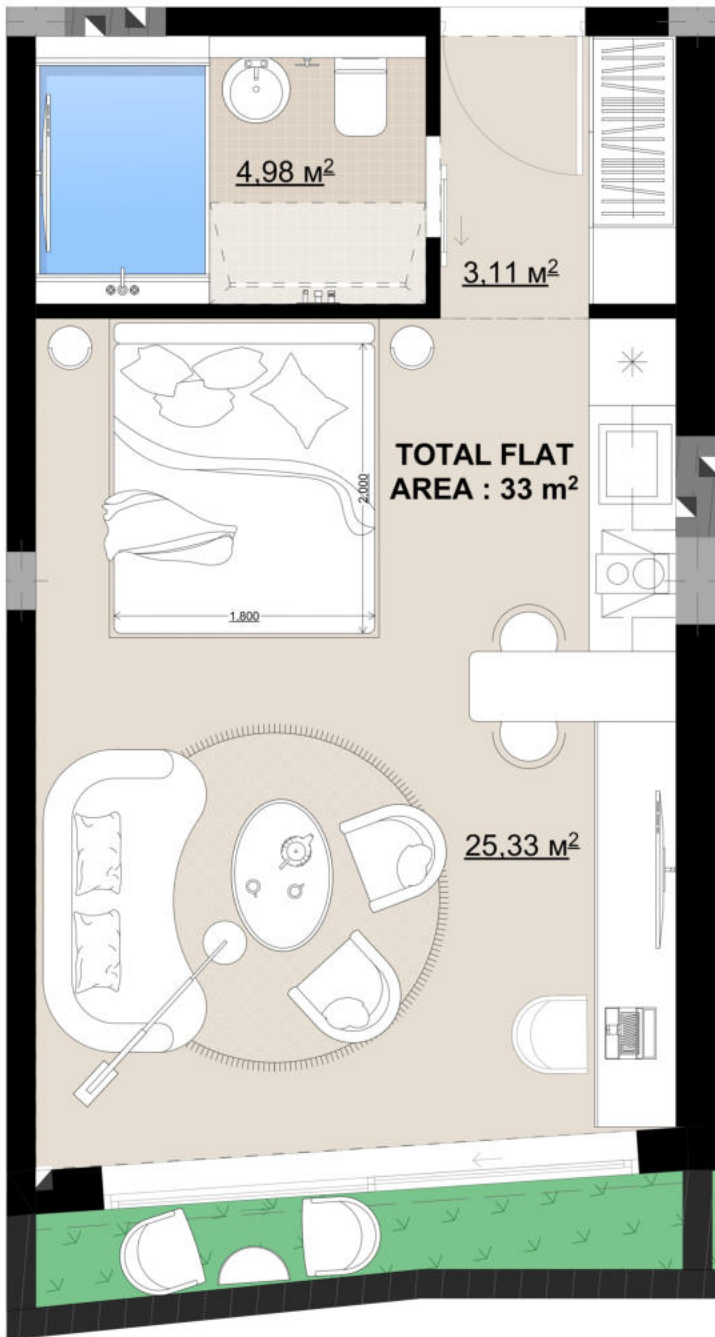

### SECTION "A"

UNIT.11 / GROUND FLOOR

FLAT AREA : 33 m<sup>2</sup>

TERRACE AREA : 0 m<sup>2</sup>

TOTAL FLAT AREA : 33 m<sup>2</sup>



GROUND FLOOR

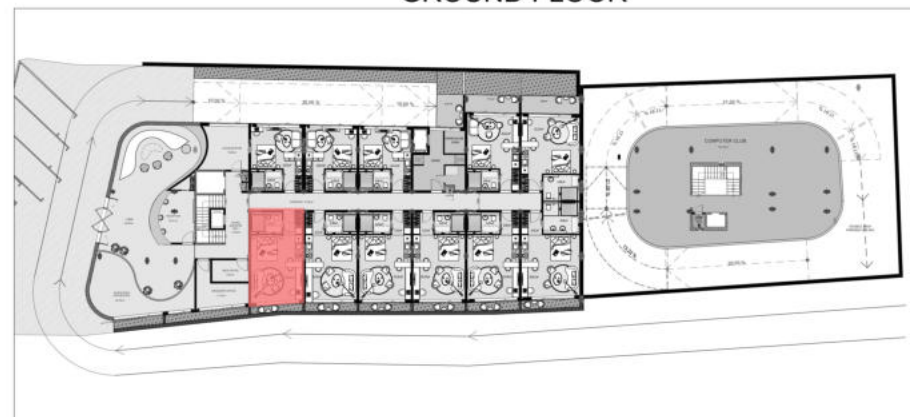

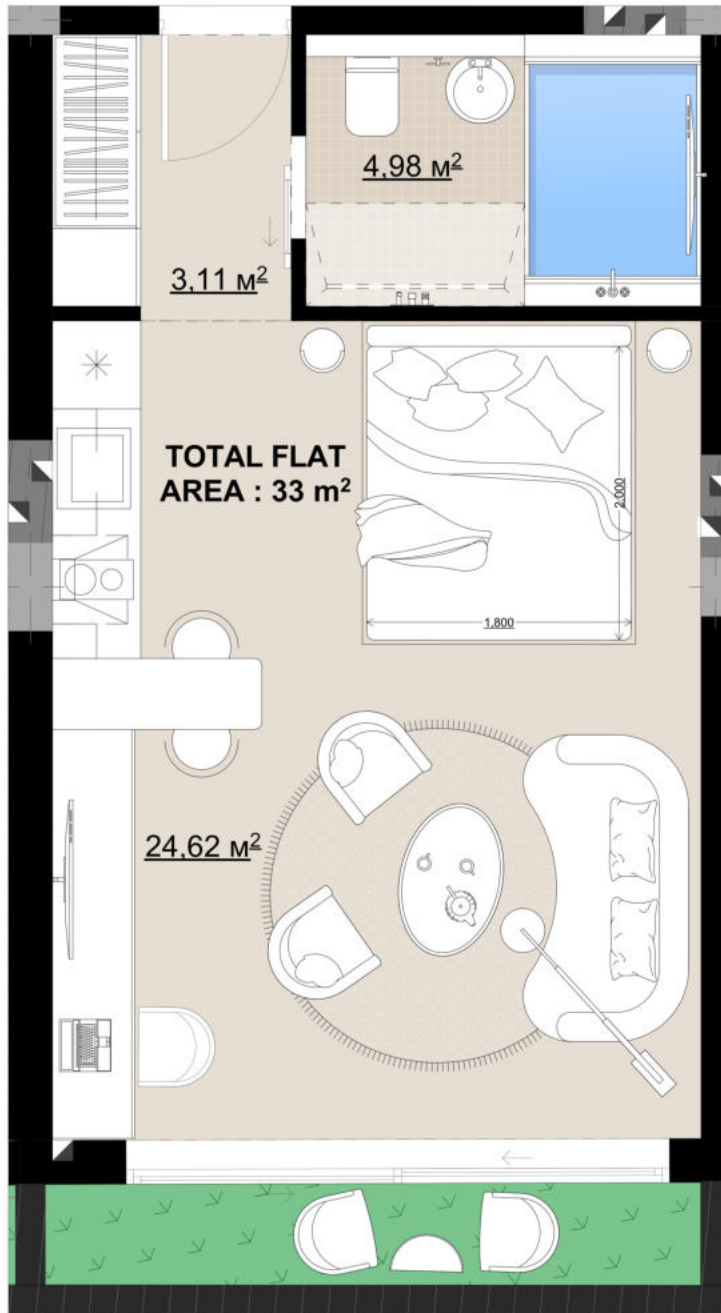

## SECTION "A"

UNIT.10 / GROUND FLOOR

FLAT AREA : 33 m<sup>2</sup>

TERRACE AREA : 0 m<sup>2</sup>

TOTAL FLAT AREA : 33 m<sup>2</sup>



GROUND FLOOR



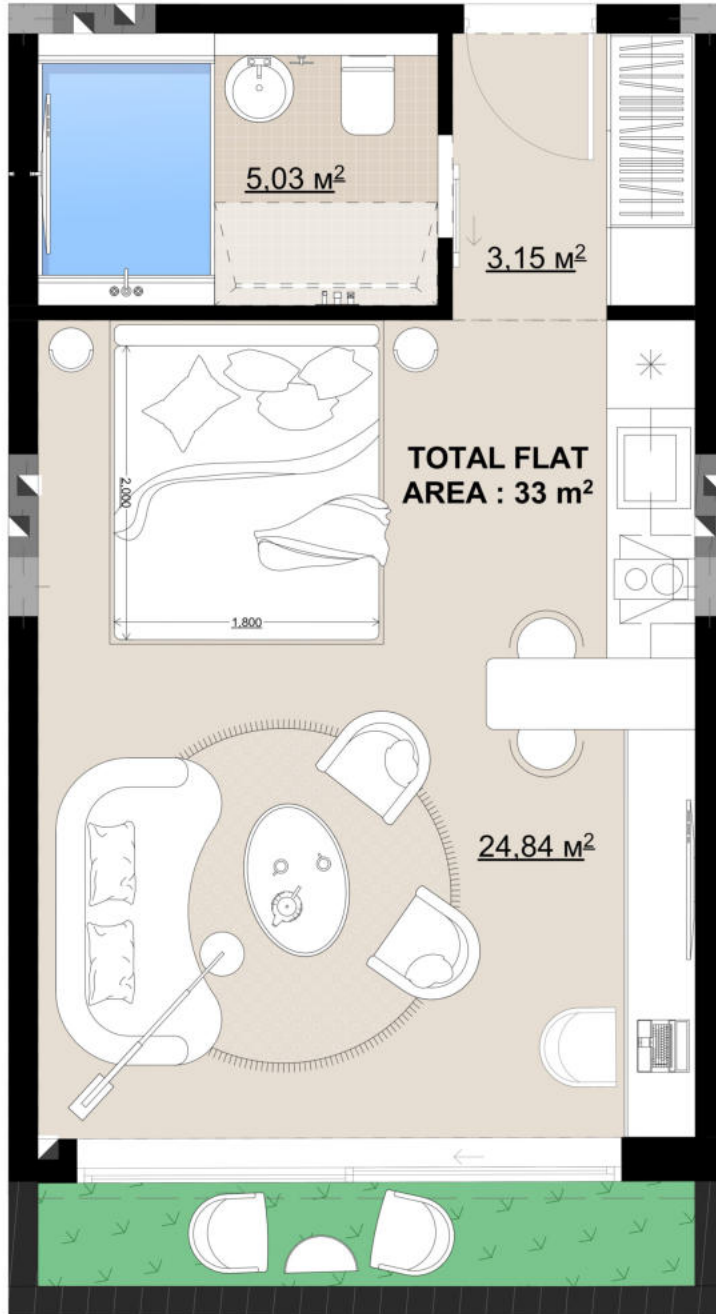

## SECTION "A"

UNIT.09 / GROUND FLOOR

FLAT AREA : 33 m<sup>2</sup>

TERRACE AREA : 0 m<sup>2</sup>

TOTAL FLAT AREA : 33 m<sup>2</sup>



GROUND FLOOR

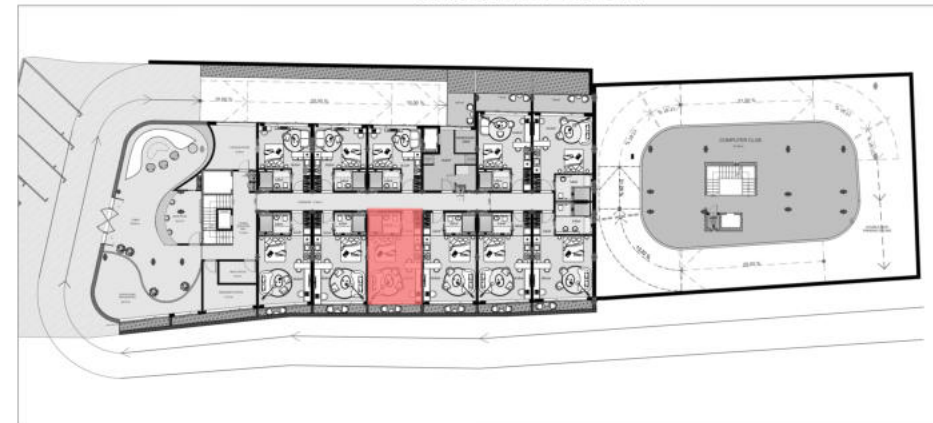

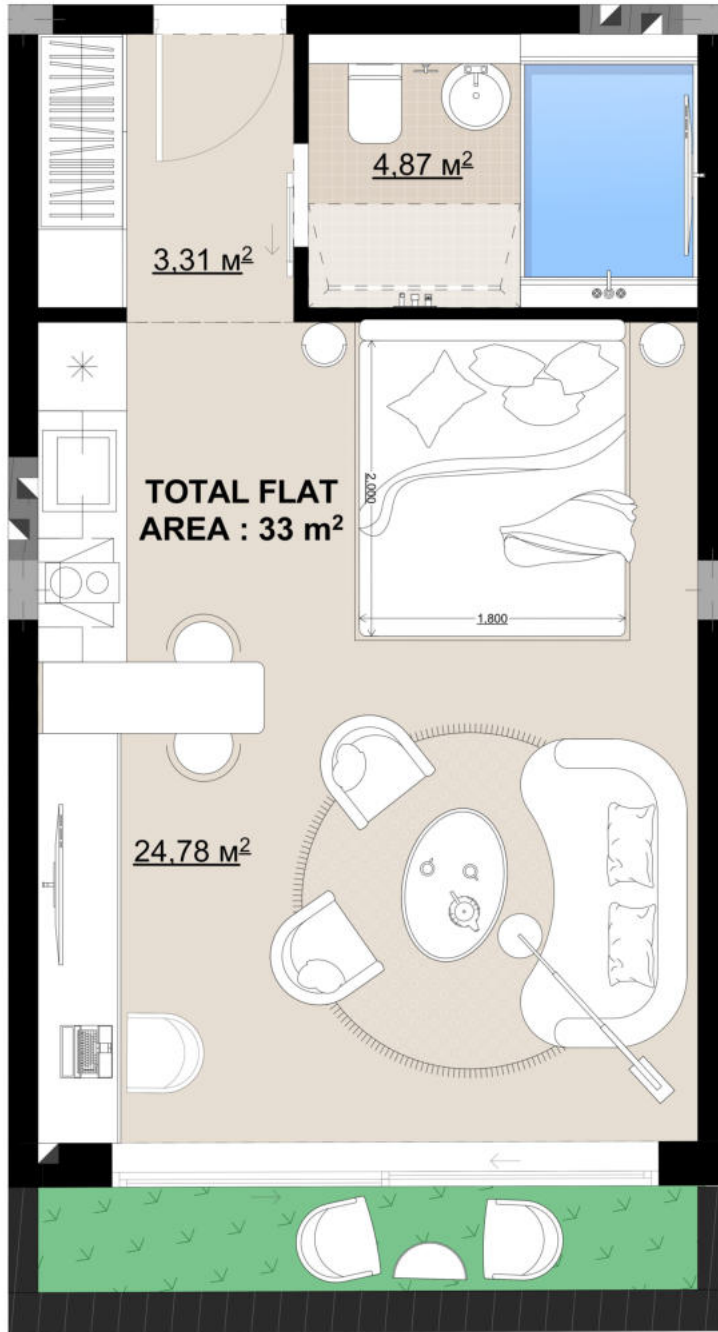

## SECTION "A"

UNIT.08 / GROUND FLOOR

FLAT AREA : 33m<sup>2</sup>

TERRACE AREA : 0 m<sup>2</sup>

TOTAL FLAT AREA : 33 m<sup>2</sup>



GROUND FLOOR

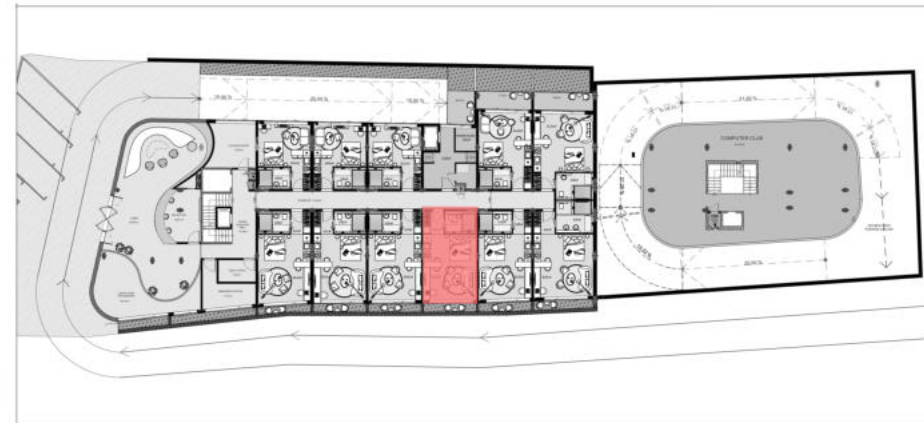

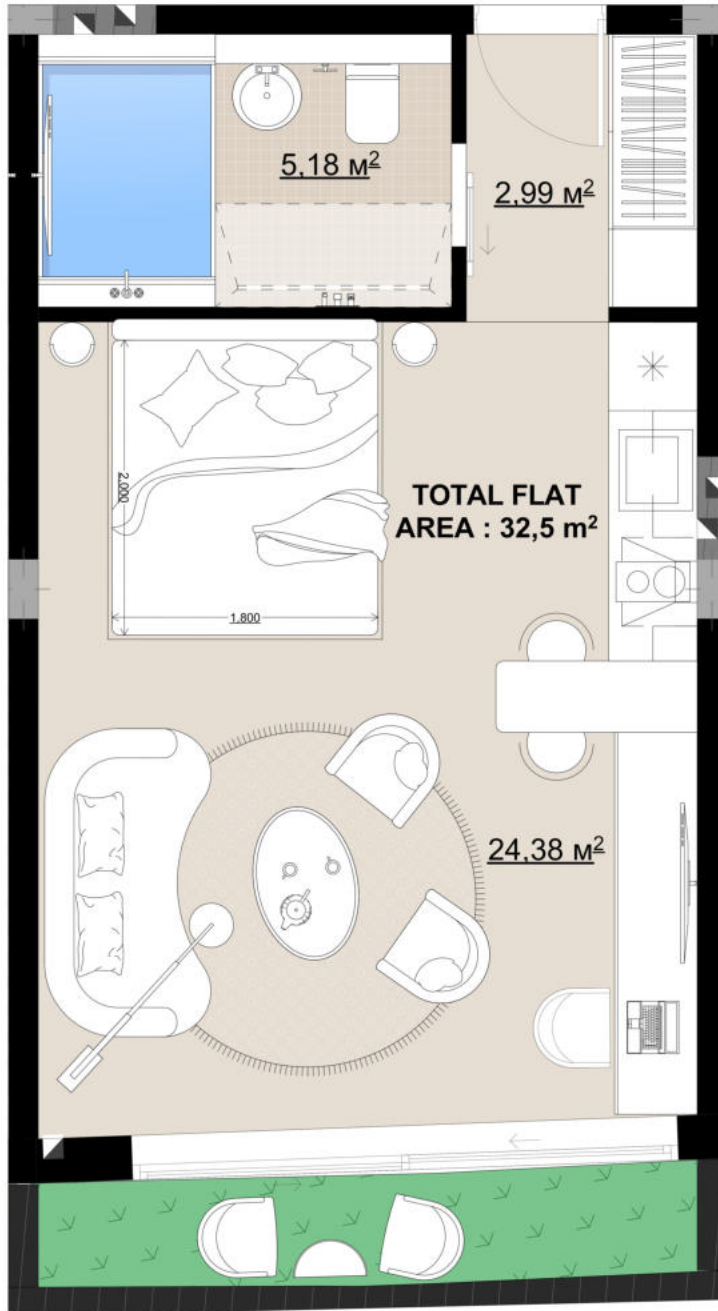

**SECTION "A"**

UNIT.07 / GROUND FLOOR

FLAT AREA : 32,5 m<sup>2</sup>

TERRACE AREA : 0 m<sup>2</sup>

TOTAL FLAT AREA : 32,5 m<sup>2</sup>



GROUND FLOOR



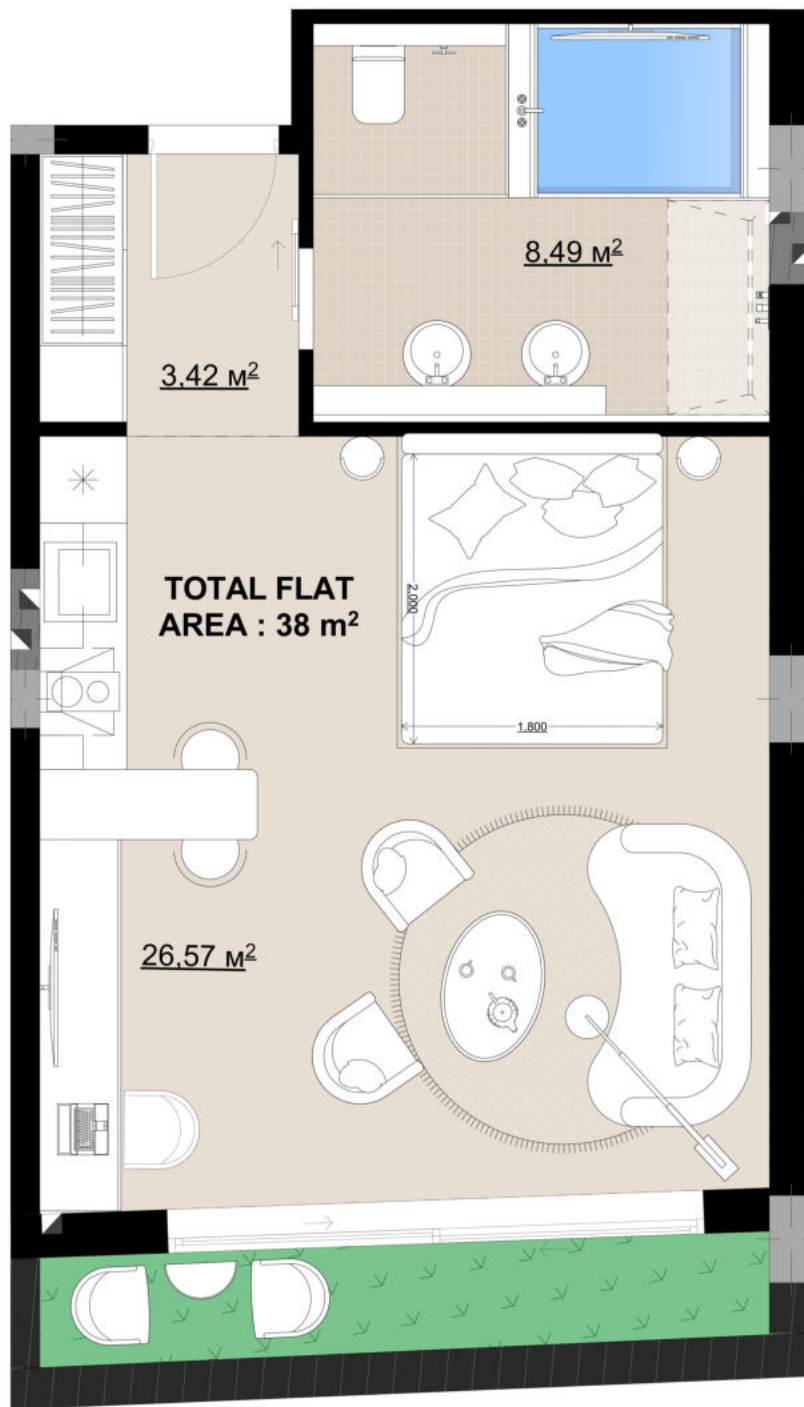

## SECTION "A"

UNIT.06 / GROUND FLOOR

FLAT AREA : 38 m<sup>2</sup>

TERRACE AREA : 0 m<sup>2</sup>

TOTAL FLAT AREA : 38 m<sup>2</sup>



GROUND FLOOR

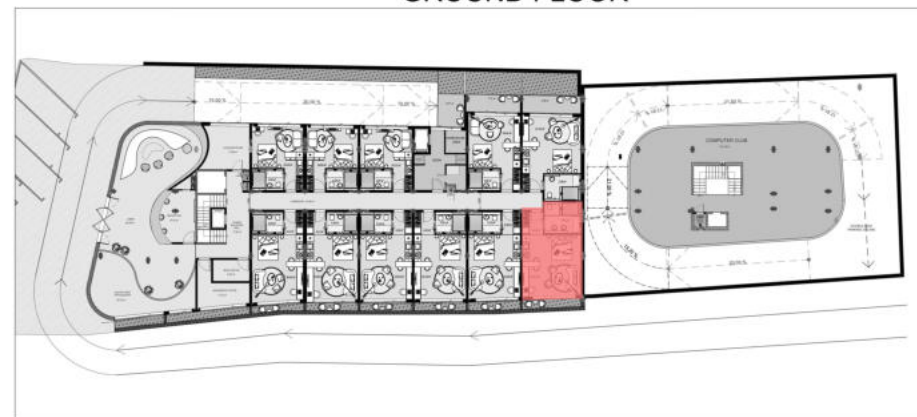

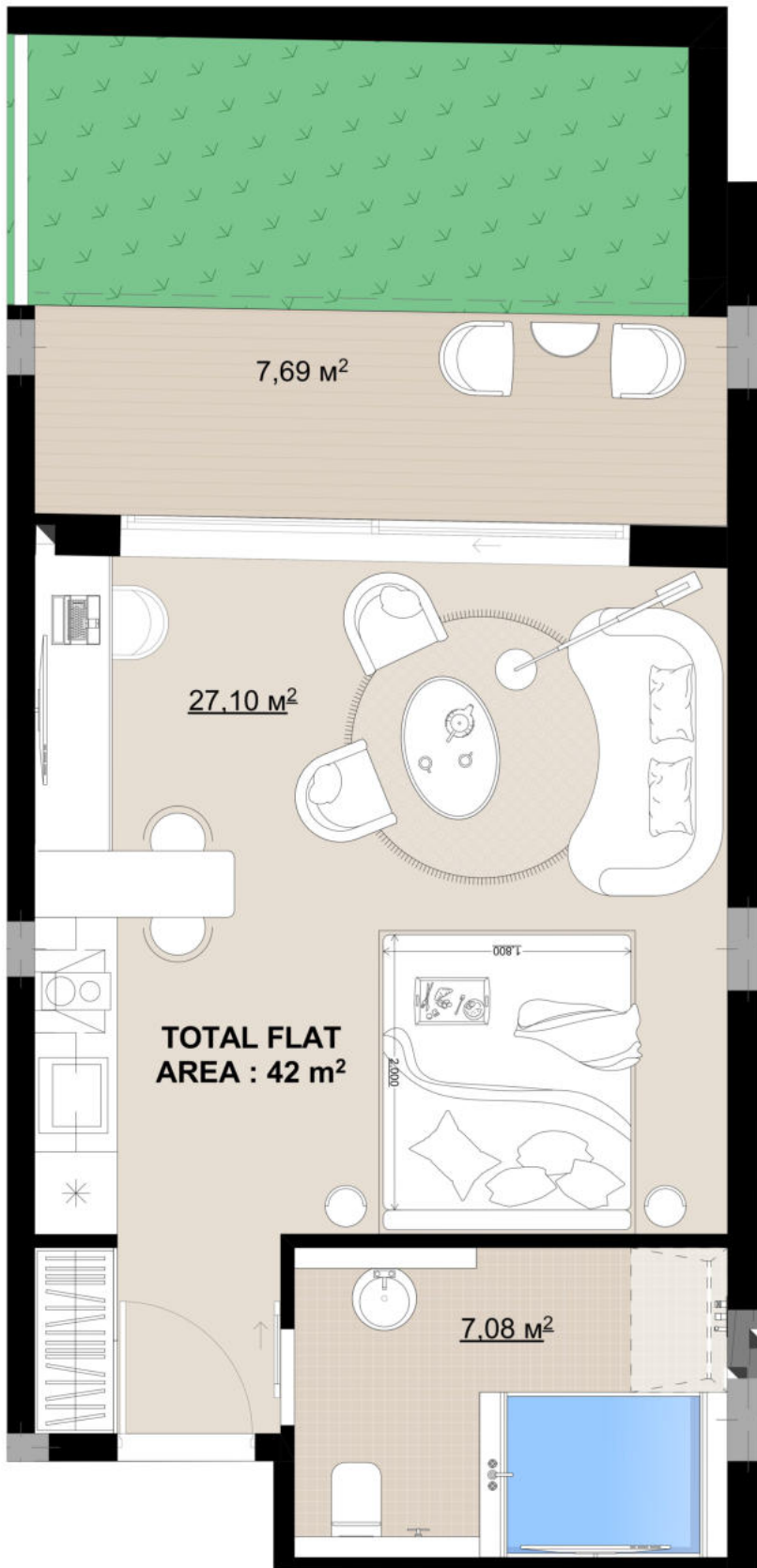

### SECTION "A"

UNIT.05 / GROUND FLOOR

FLAT AREA : 34.18 m<sup>2</sup>

TERRACE AREA : 7,69 m<sup>2</sup>

TOTAL FLAT AREA : 42 m<sup>2</sup>



GROUND FLOOR

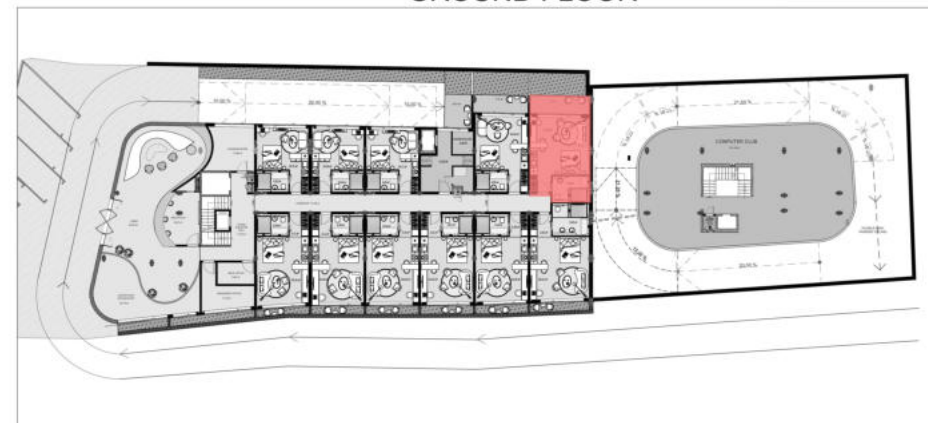

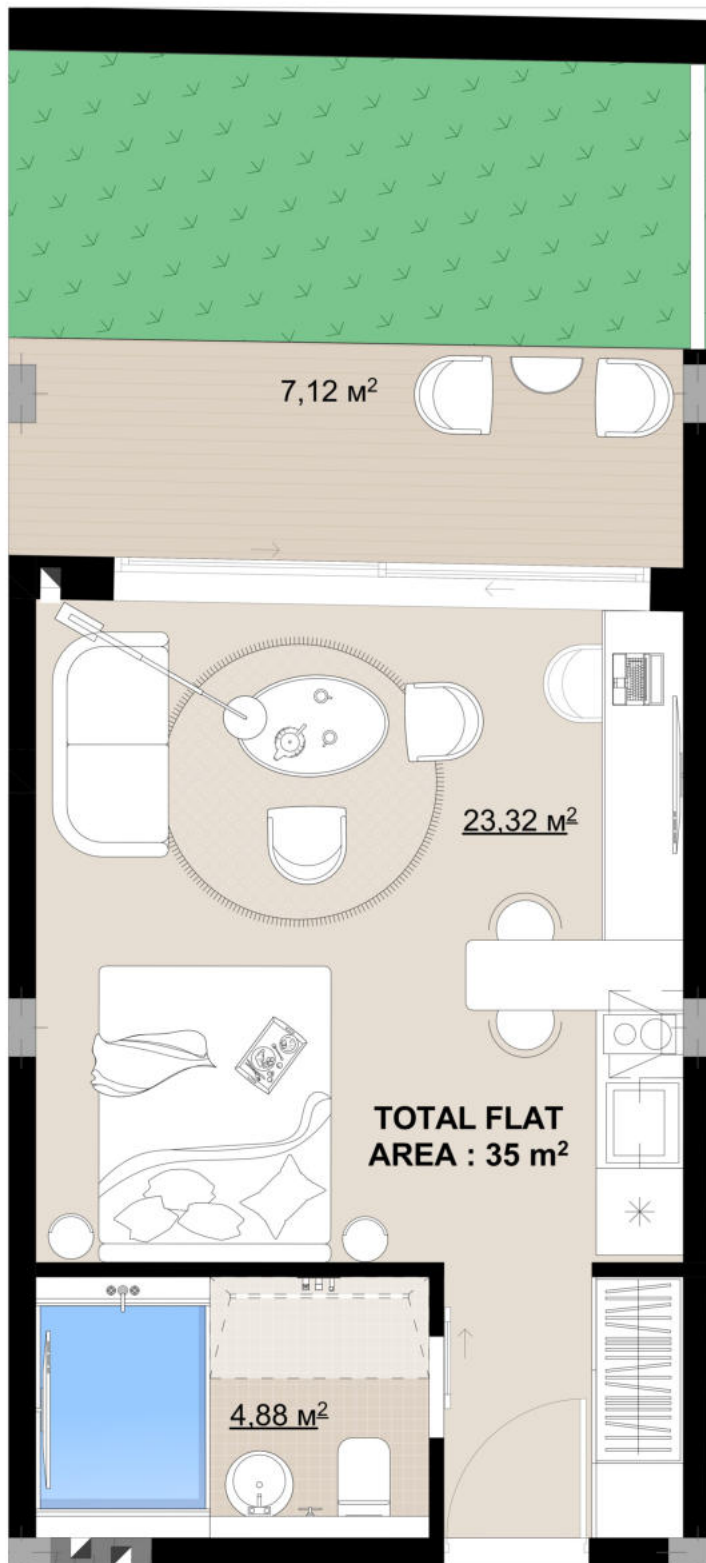

## SECTION "A"

UNIT.04 / GROUND FLOOR

FLAT AREA : 28,2 m<sup>2</sup>

TERRACE AREA : 7,12 m<sup>2</sup>

TOTAL FLAT AREA : 35 m<sup>2</sup>



GROUND FLOOR

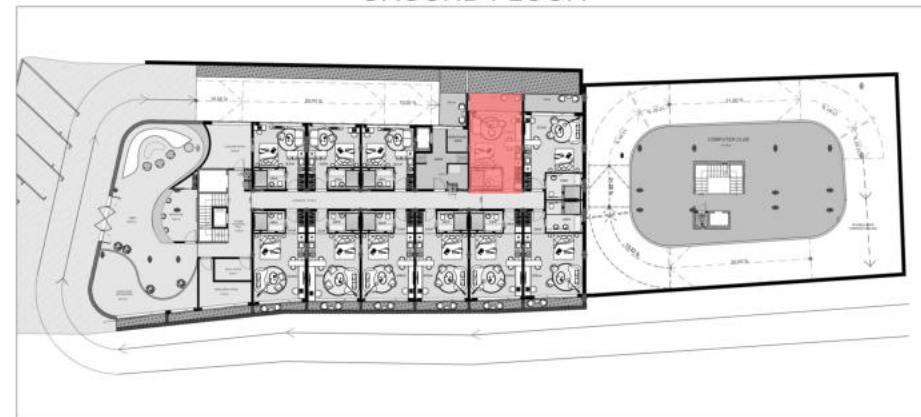

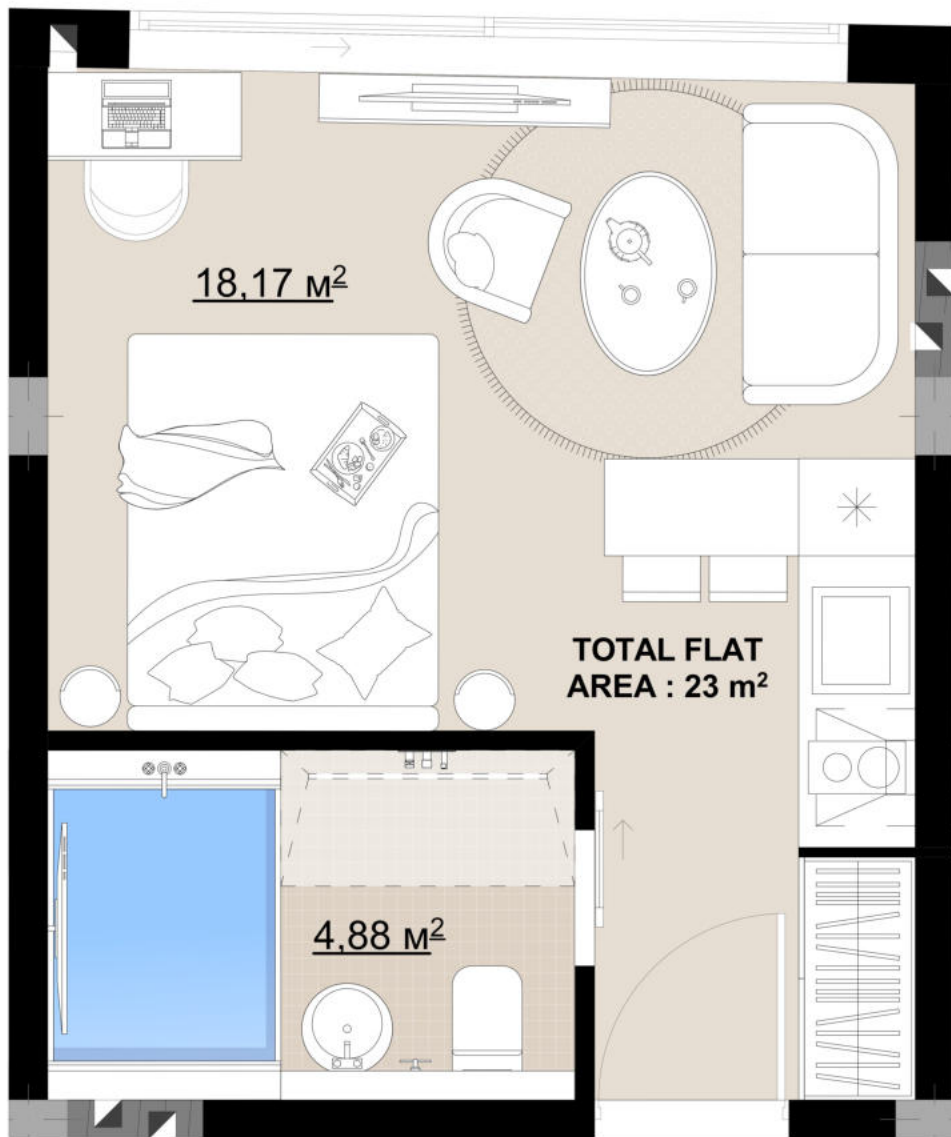

### SECTION "A"

UNIT.03 / GROUND FLOOR

FLAT AREA : 23 m<sup>2</sup>

TERRACE AREA : 0.00 m<sup>2</sup>

TOTAL FLAT AREA : 23 m<sup>2</sup>



GROUND FLOOR

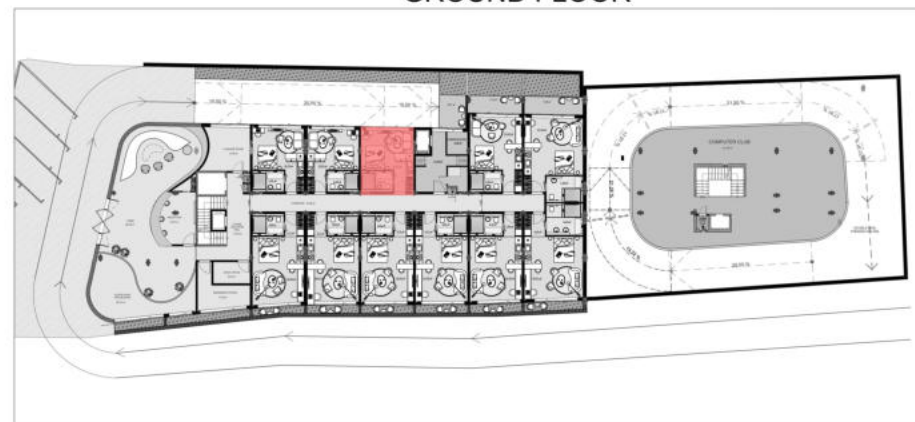

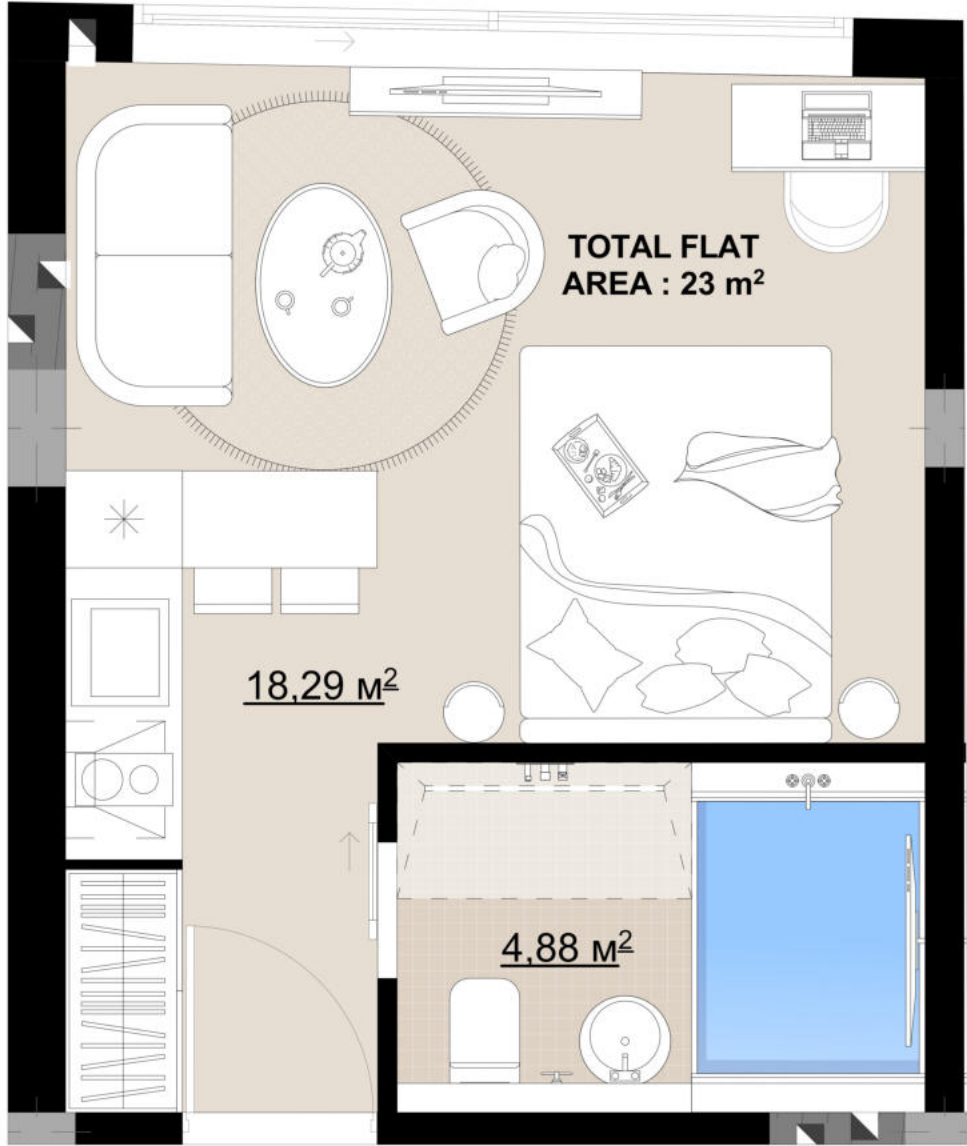

**SECTION "A"**

**UNIT.02 / GROUND FLOOR**

**FLAT AREA : 23 m<sup>2</sup>**

**TERRACE AREA : 0.00 m<sup>2</sup>**

**TOTAL FLAT AREA : 23 m<sup>2</sup>**



**GROUND FLOOR**

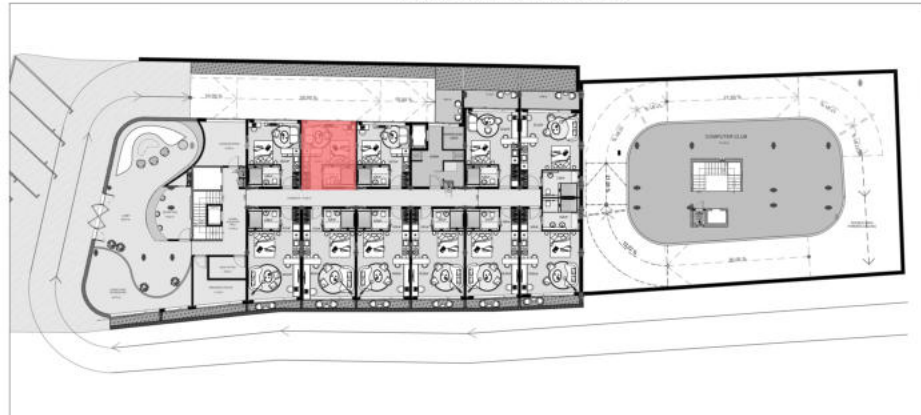

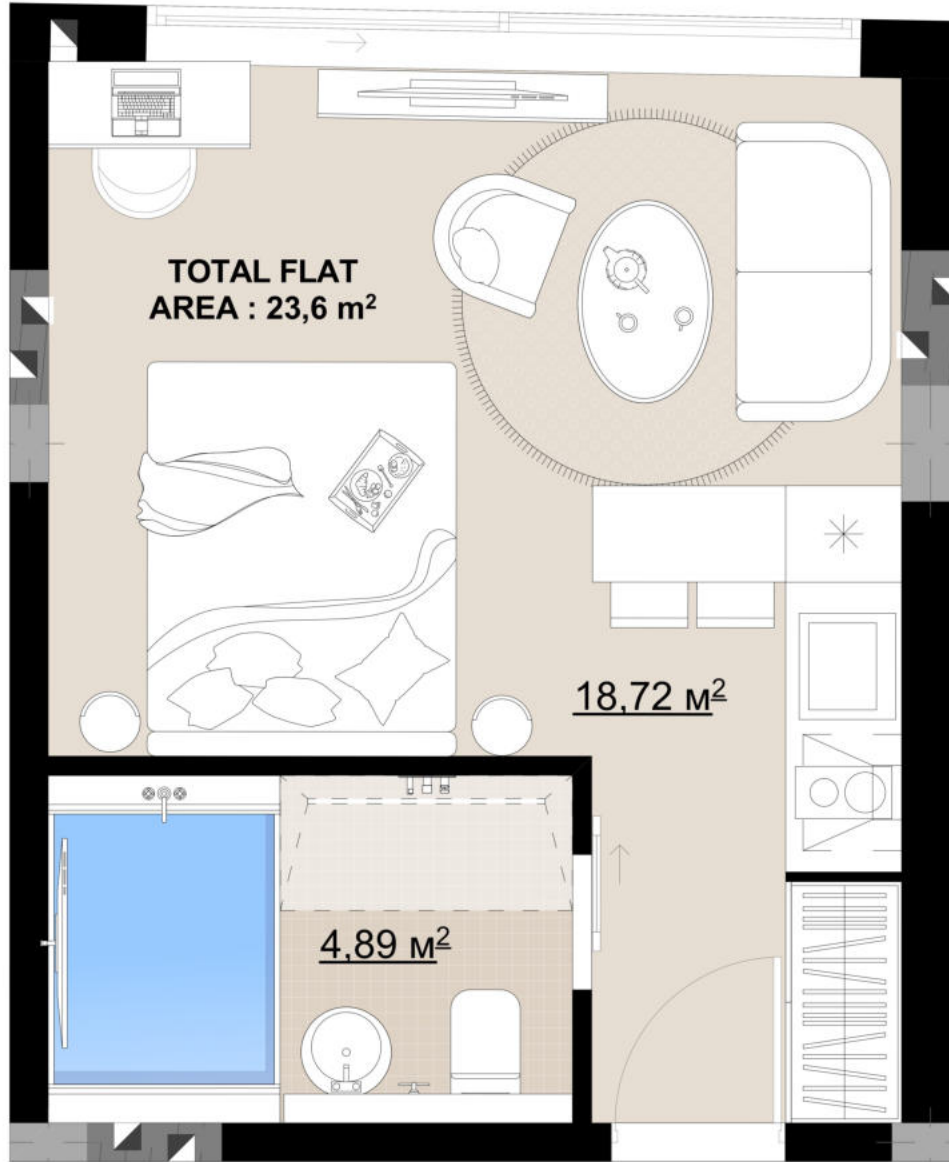

**SECTION "A"**

UNIT.01 / GROUND FLOOR

FLAT AREA : 23,6 m<sup>2</sup>

TERRACE AREA : 0.00 m<sup>2</sup>

**TOTAL FLAT AREA : 23,6 m<sup>2</sup>**



GROUND FLOOR

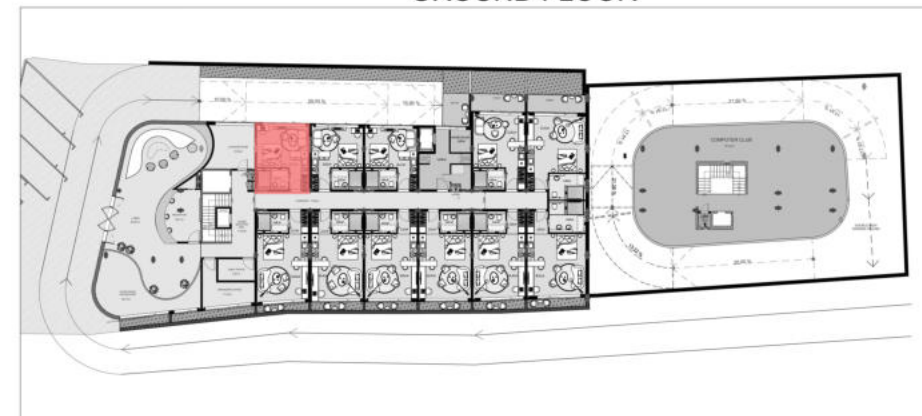

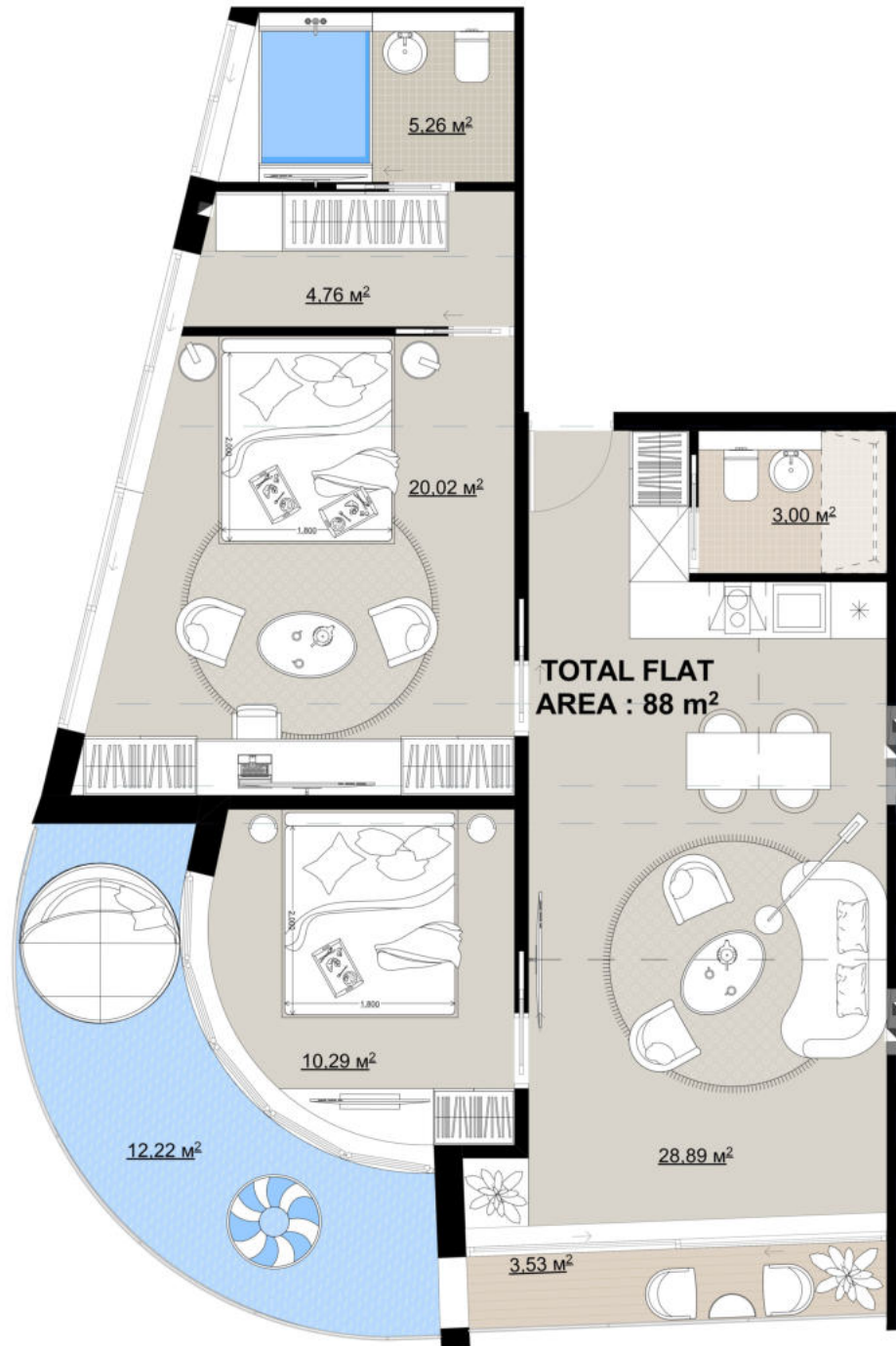

## SECTION "A"

UNIT 136

FLAT AREA : 72,22 m<sup>2</sup>

TERRACE AREA : 15,75 m<sup>2</sup>

TOTAL FLAT AREA : 88 m<sup>2</sup>



5TH FLOOR

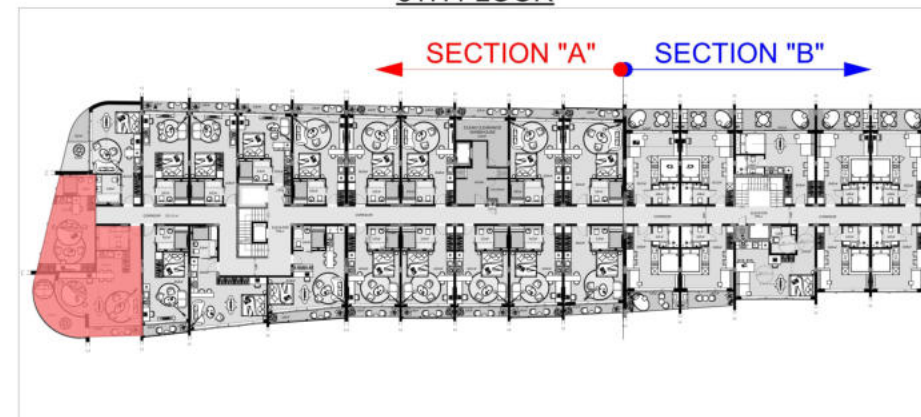

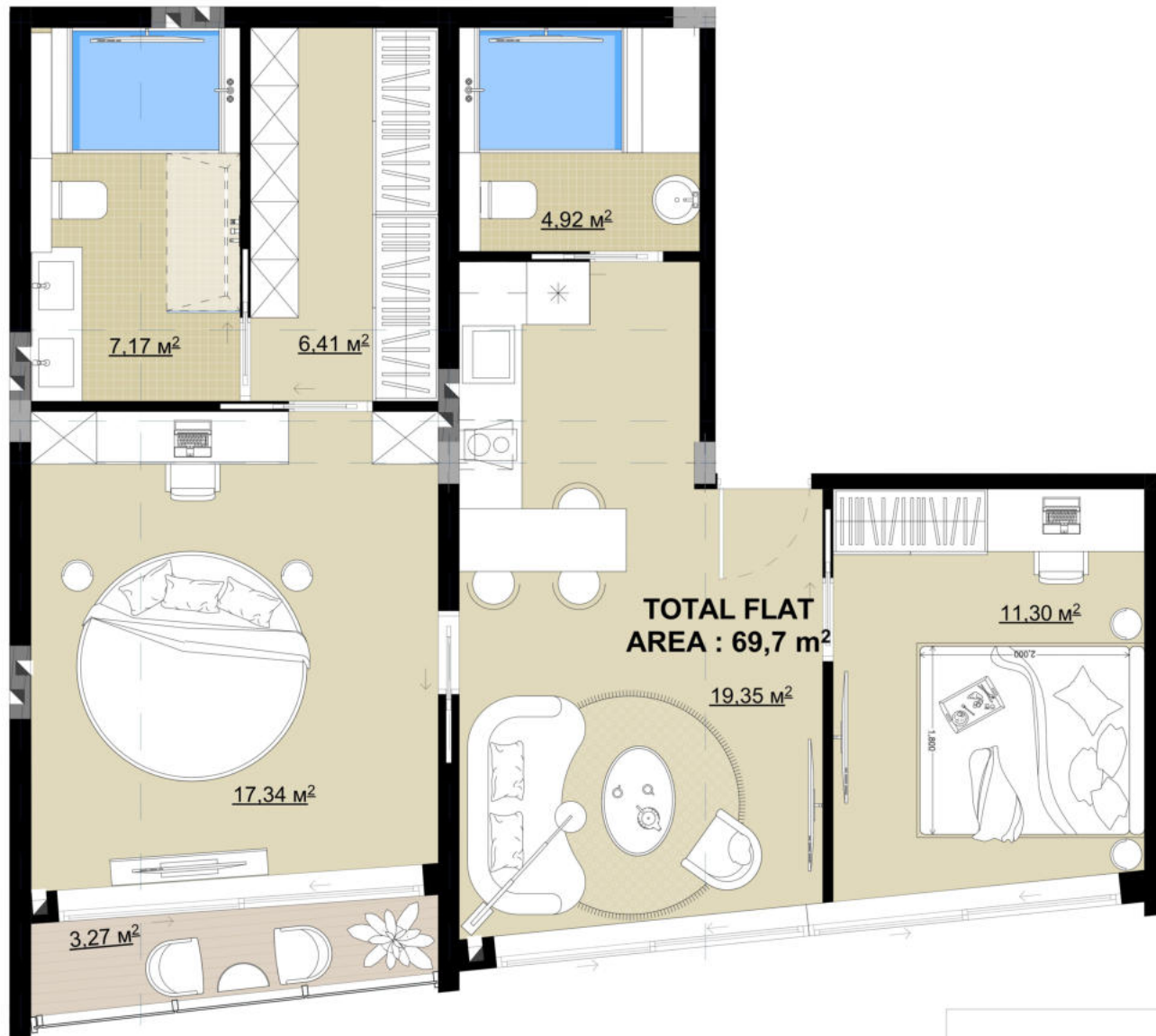

### SECTION "A"

UNIT 135

FLAT AREA : 66,5 m<sup>2</sup>

TERRACE AREA : 3,27 m<sup>2</sup>

TOTAL FLAT AREA : 69,7 m<sup>2</sup>



5TH FLOOR

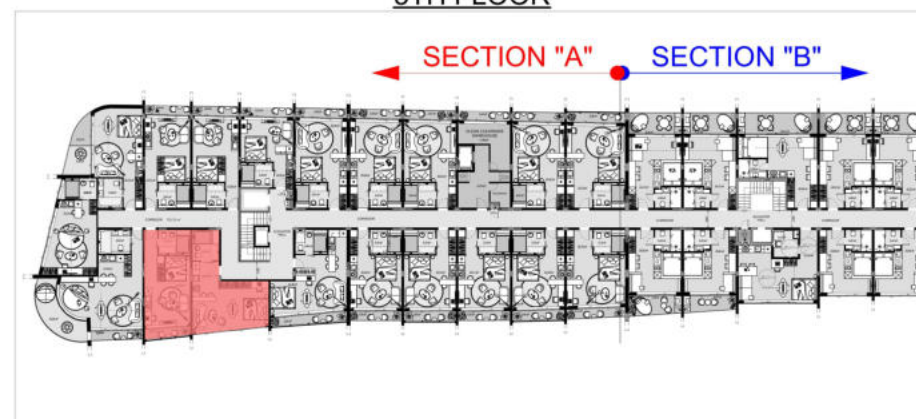

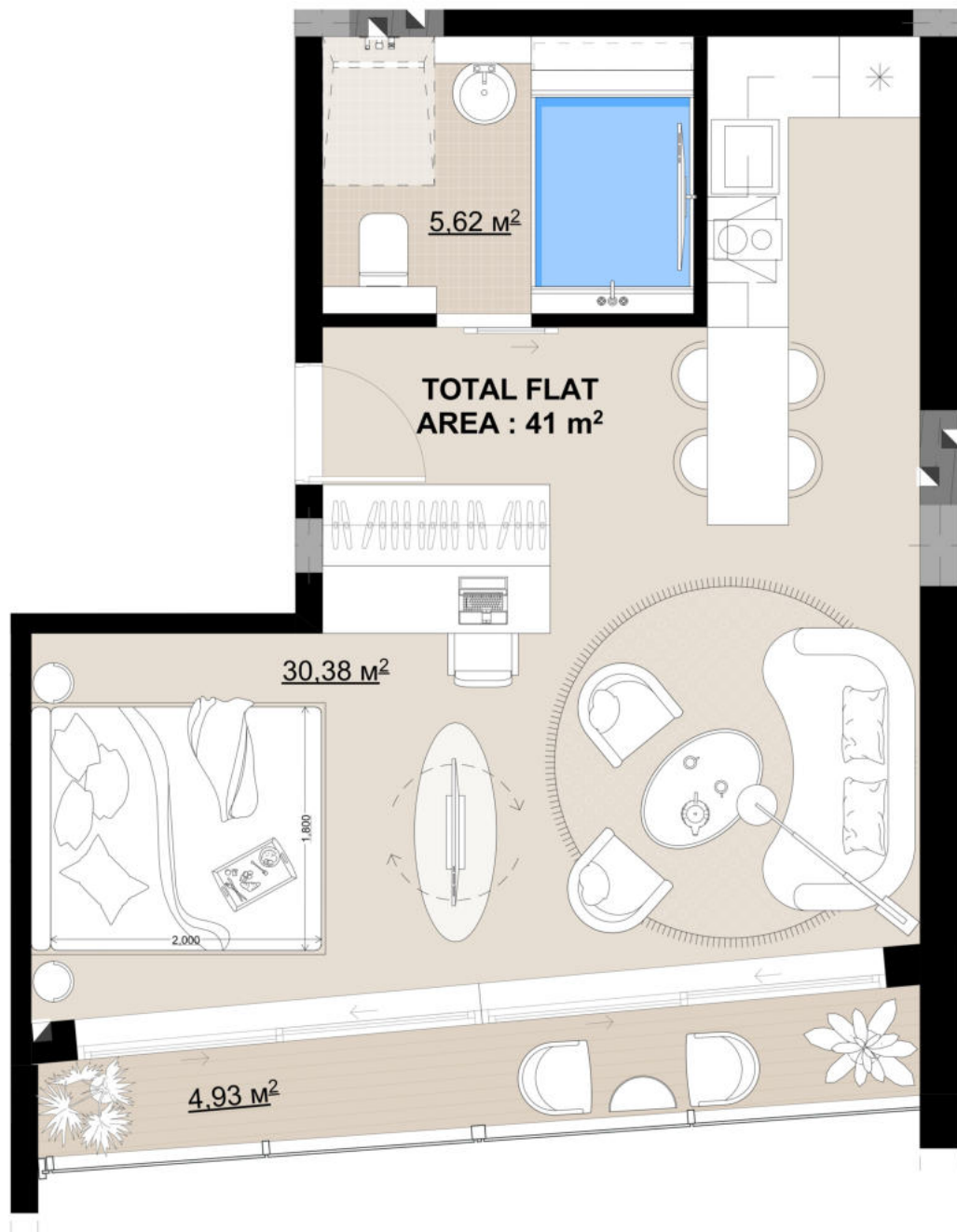

## SECTION "A"

UNIT 134

FLAT AREA : 36 m<sup>2</sup>

TERRACE AREA : 4,93 m<sup>2</sup>

TOTAL FLAT AREA : 41 m<sup>2</sup>



5TH FLOOR

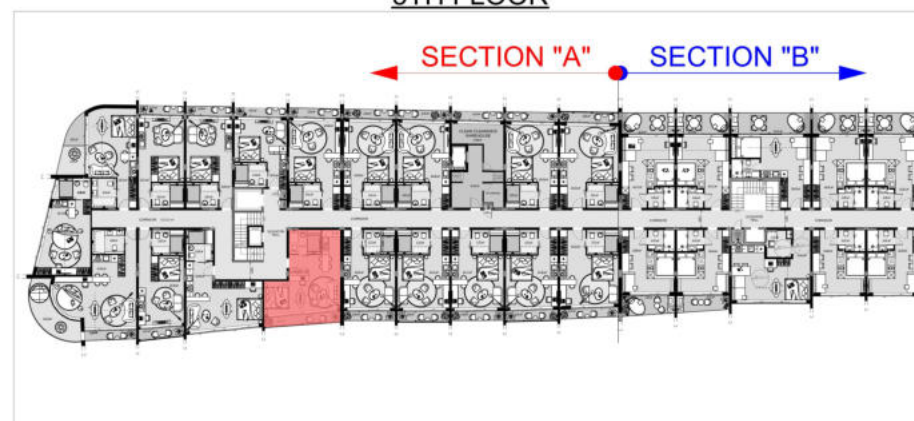

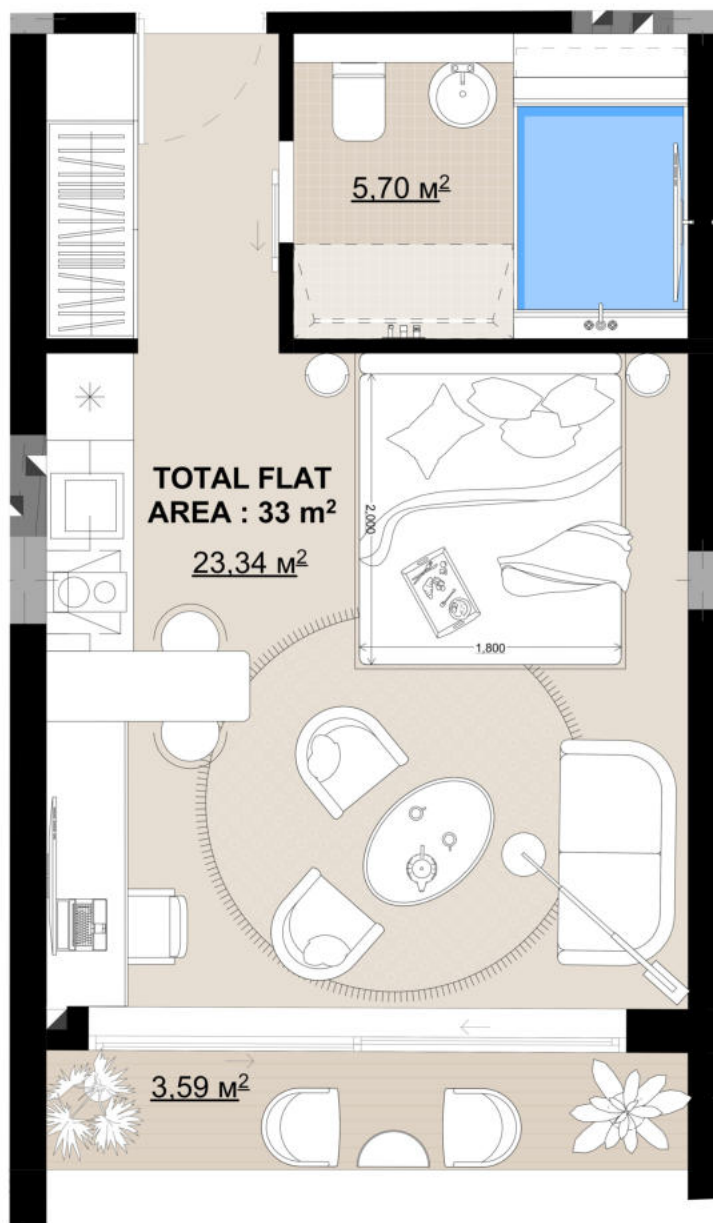

## SECTION "A"

UNIT 133

FLAT AREA : 29,04 m<sup>2</sup>

TERRACE AREA : 3,59 m<sup>2</sup>

TOTAL FLAT AREA : 33 m<sup>2</sup>



5TH FLOOR

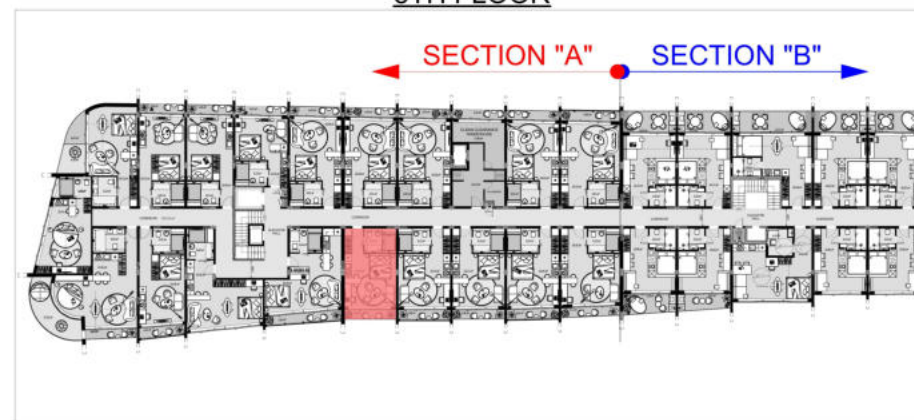

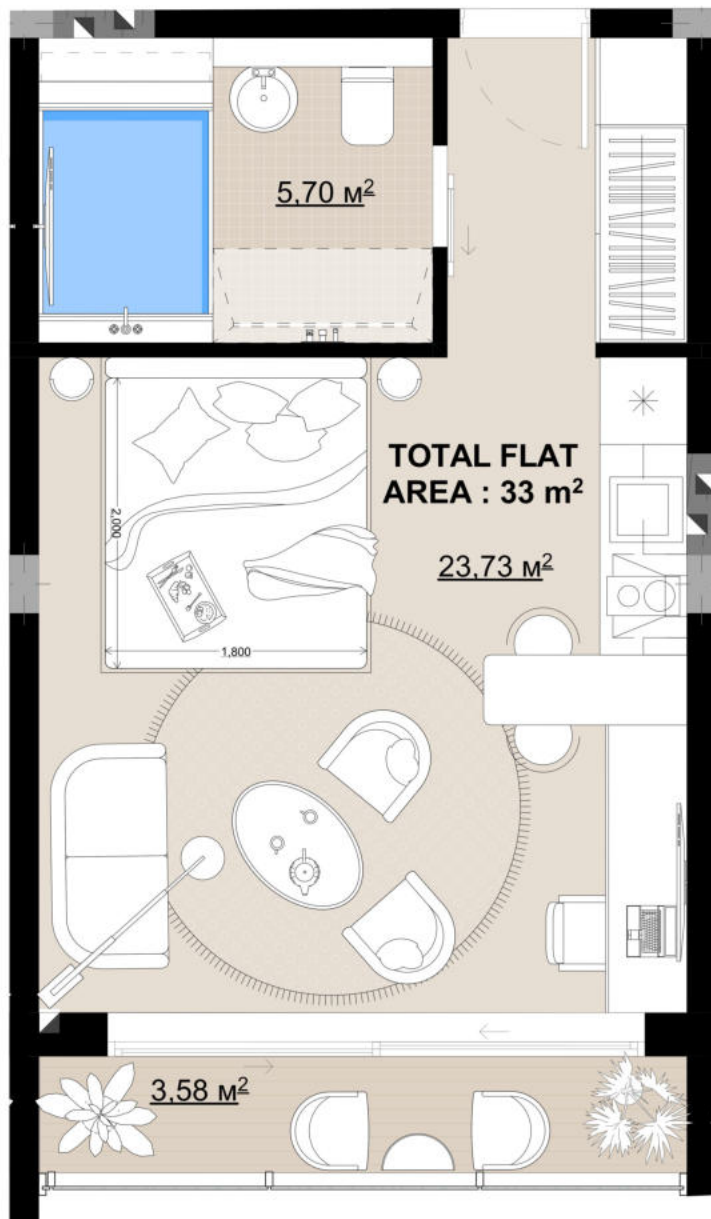

## SECTION "A"

UNIT 132

FLAT AREA : 29,43 m<sup>2</sup>

TERRACE AREA : 3,58 m<sup>2</sup>

TOTAL FLAT AREA : 33 m<sup>2</sup>



5TH FLOOR

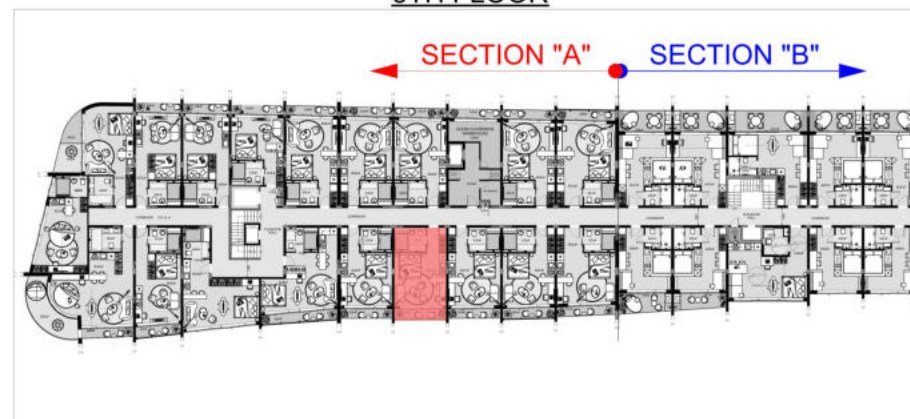

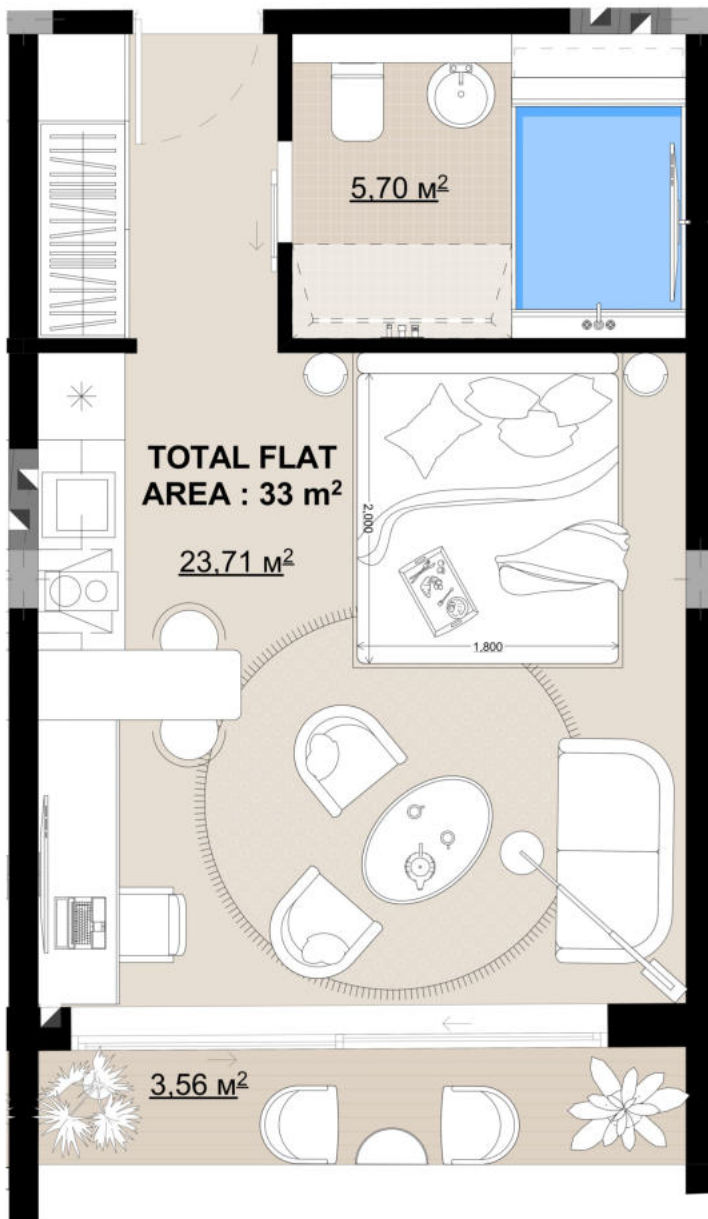

**SECTION "A"**

**UNIT 131**

FLAT AREA : 29,41 m<sup>2</sup>

TERRACE AREA : 3,56 m<sup>2</sup>

**TOTAL FLAT AREA : 33 m<sup>2</sup>**



**5TH FLOOR**

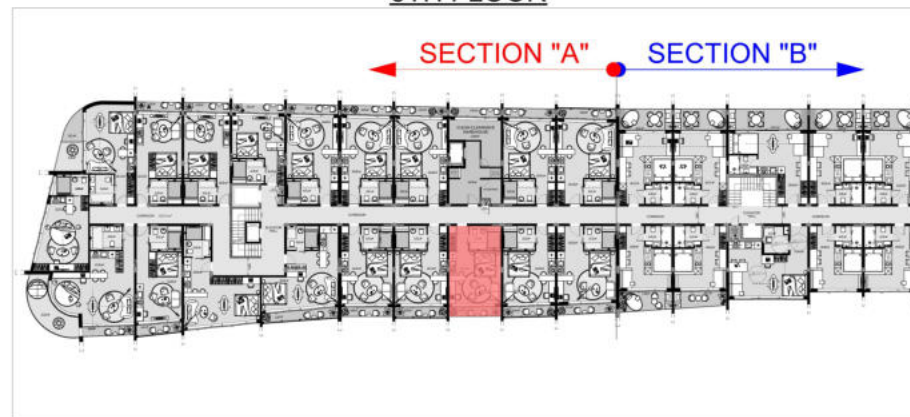

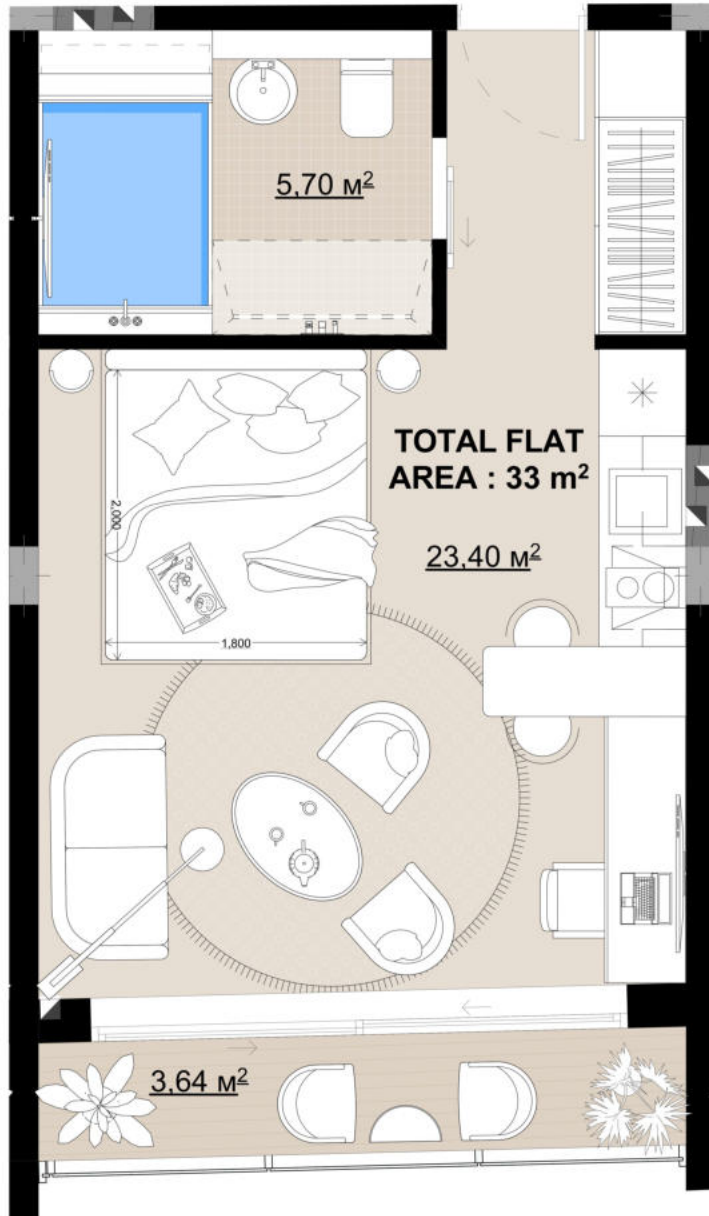

## SECTION "A"

UNIT 130

FLAT AREA : 29,1 m<sup>2</sup>

TERRACE AREA : 3,64 m<sup>2</sup>

TOTAL FLAT AREA : 33 m<sup>2</sup>



5TH FLOOR

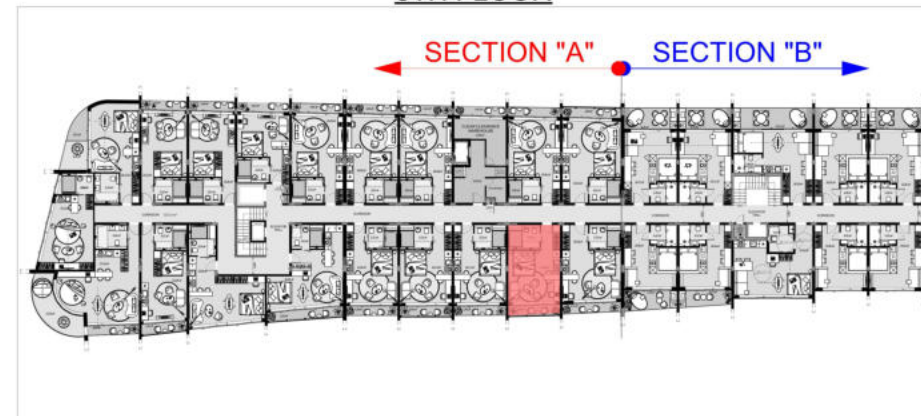

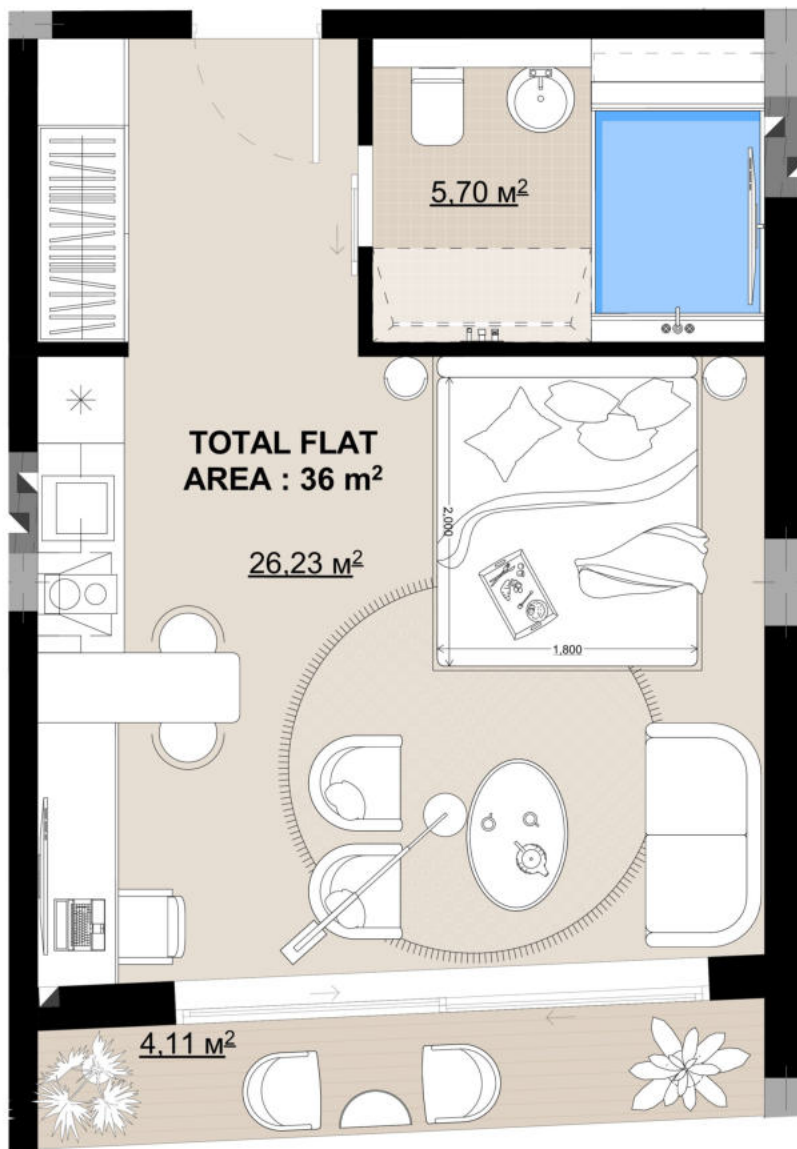

## SECTION "A"

UNIT 129

FLAT AREA : 31.93 m<sup>2</sup>

TERRACE AREA : 4,11 m<sup>2</sup>

TOTAL FLAT AREA : 36 m<sup>2</sup>



5TH FLOOR

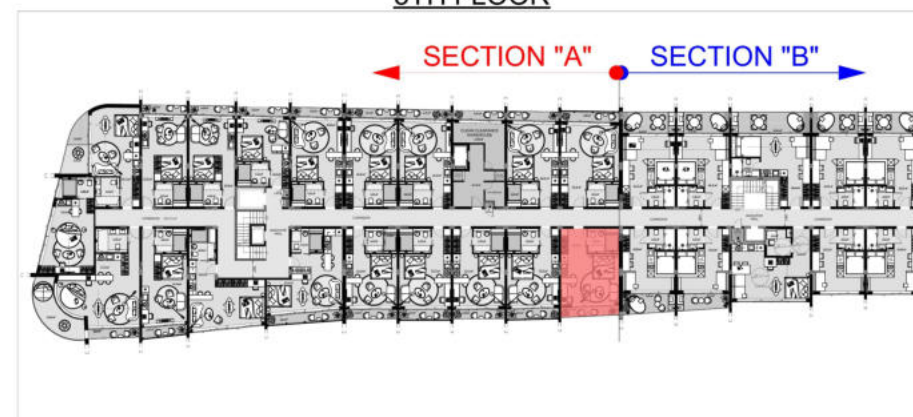

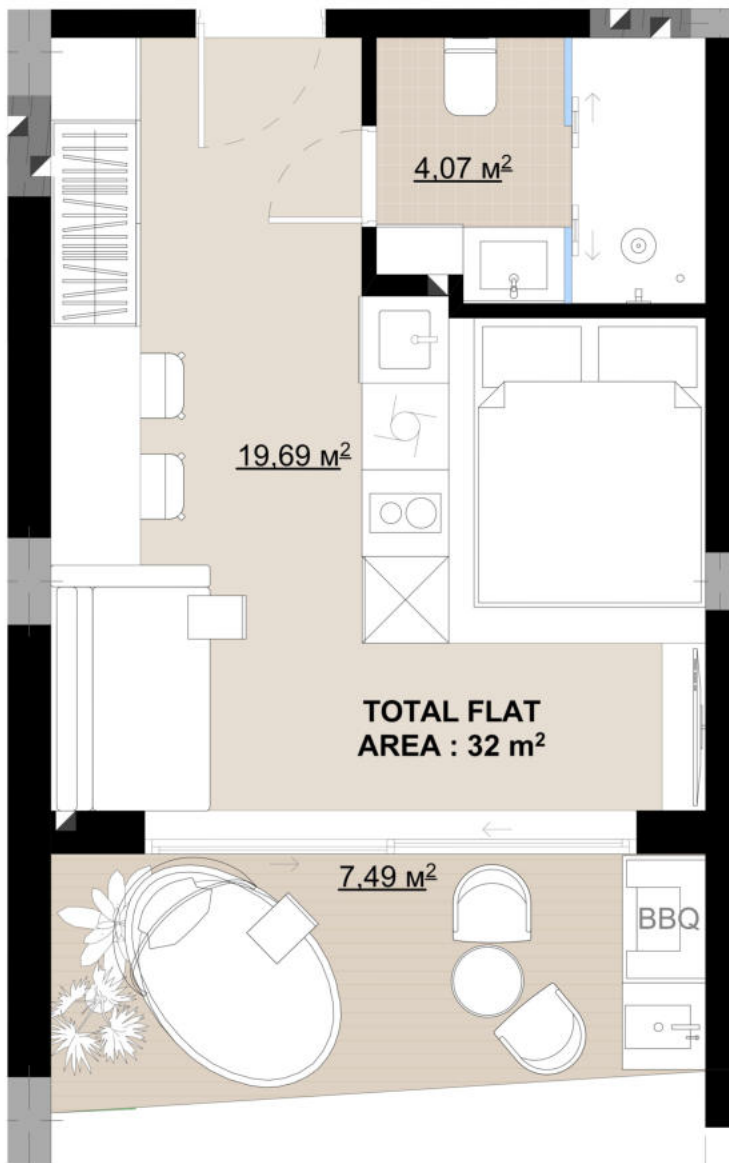

## SECTION "B"

UNIT 128

FLAT AREA : 23,68 m<sup>2</sup>

TERRACE AREA : 7,49 m<sup>2</sup>

TOTAL FLAT AREA : 32 m<sup>2</sup>



5TH FLOOR

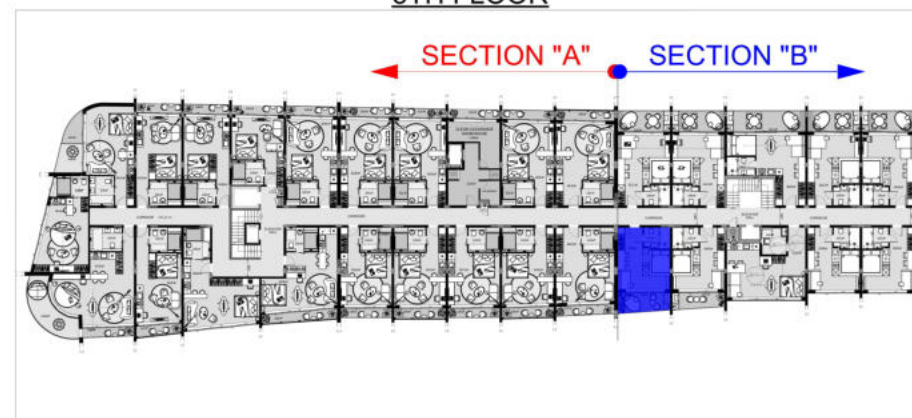

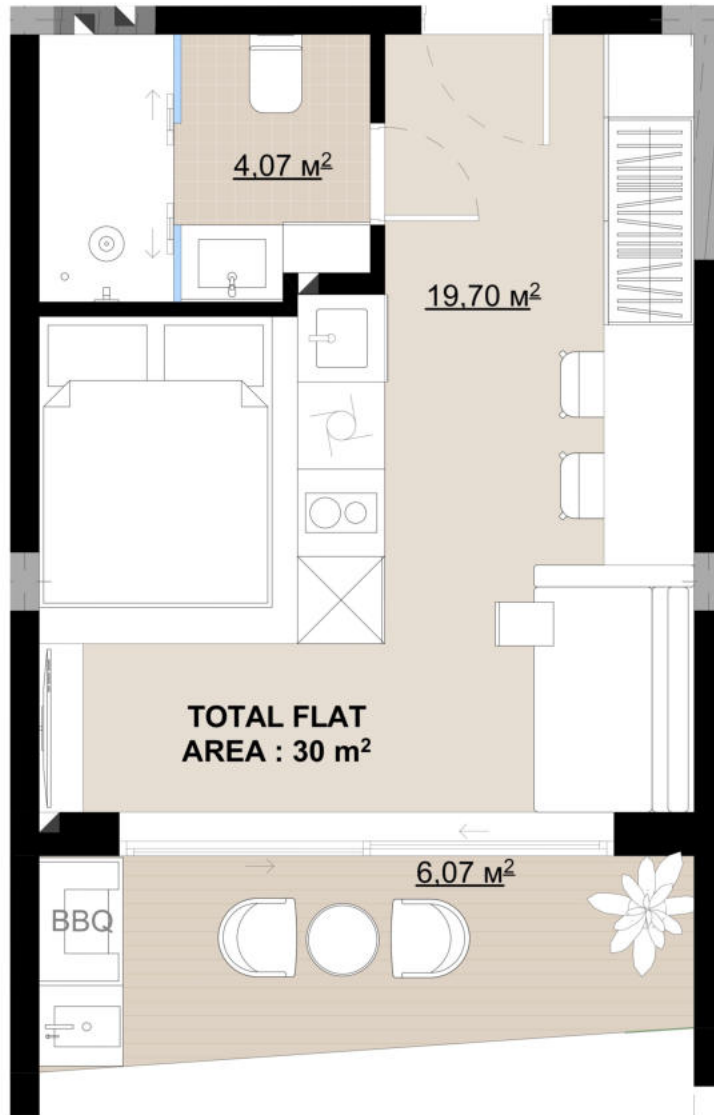

## SECTION "B"

UNIT 127

FLAT AREA : 23,5 m<sup>2</sup>

TERRACE AREA : 6,07 m<sup>2</sup>

TOTAL FLAT AREA : 30 m<sup>2</sup>



5TH FLOOR

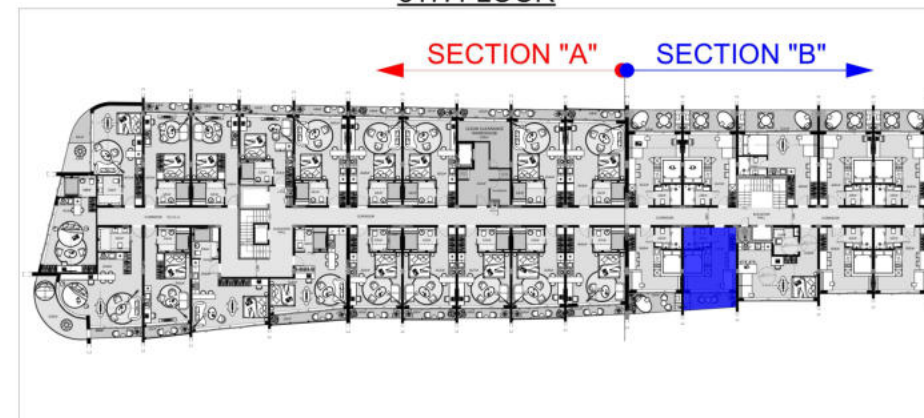



## SECTION "B"

UNIT 126

FLAT AREA : 37 m<sup>2</sup>

TERRACE AREA : 0 m<sup>2</sup>

TOTAL FLAT AREA : 37 m<sup>2</sup>

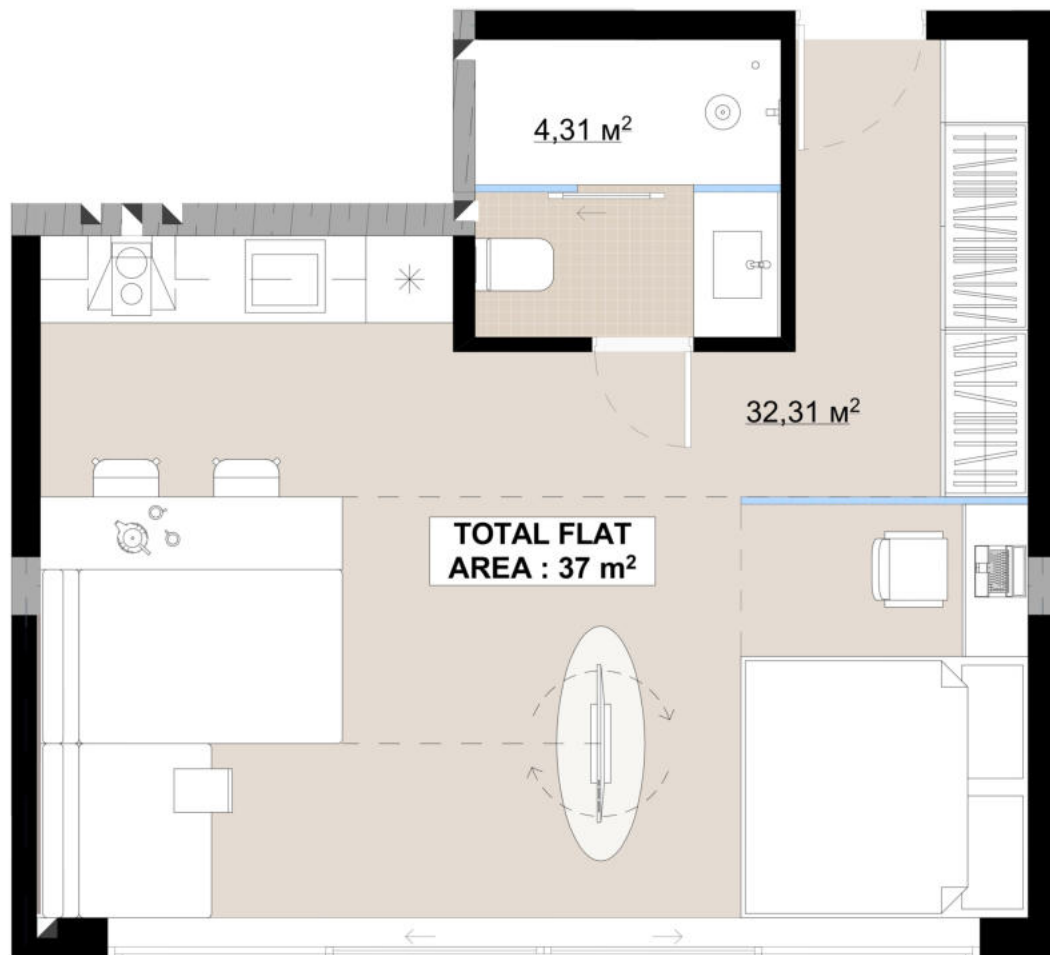

5TH FLOOR

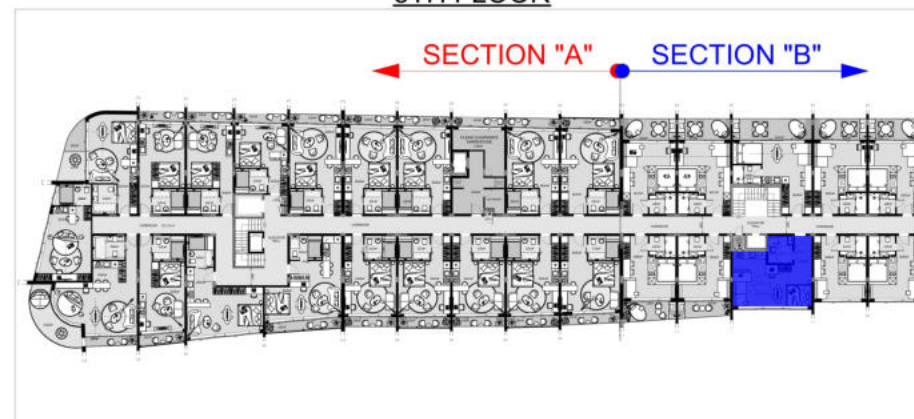

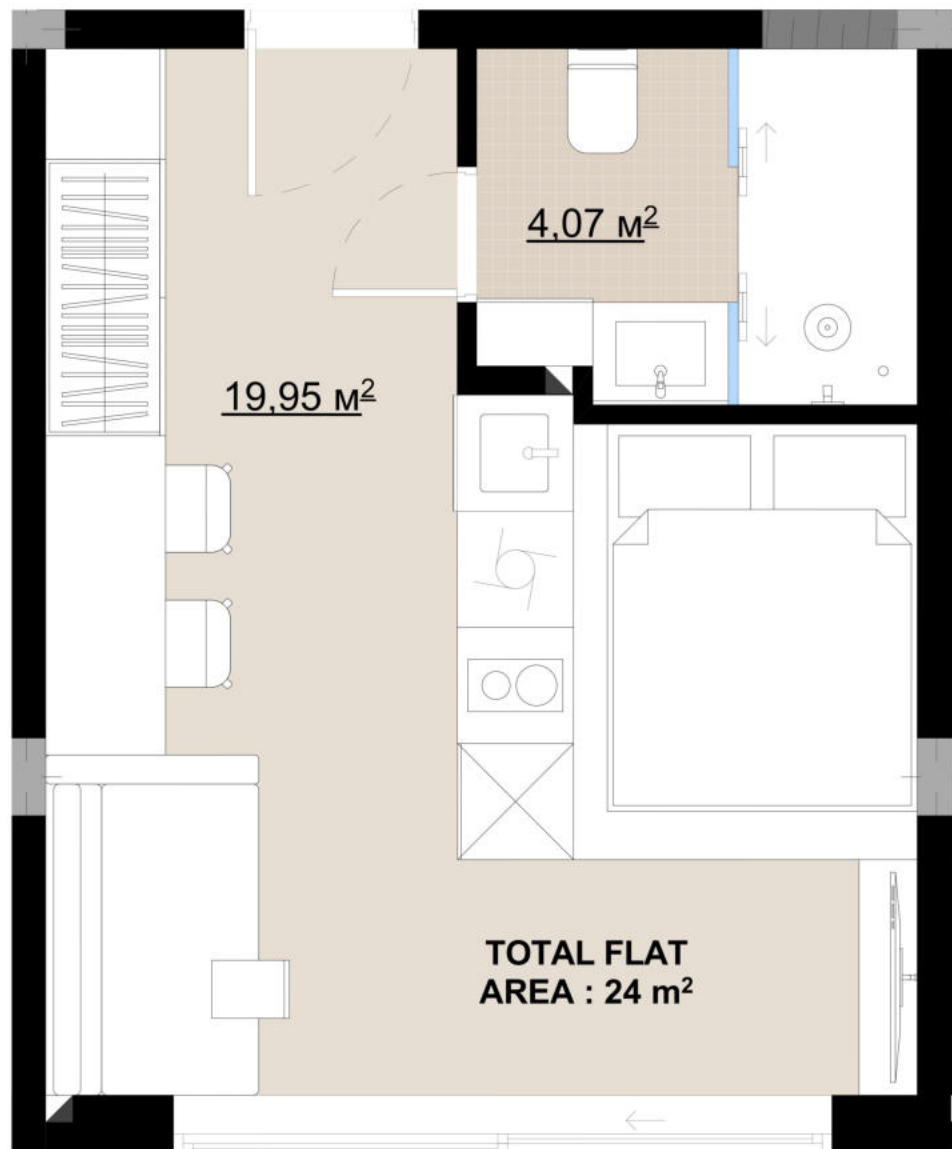

## SECTION "B"

UNIT 125

FLAT AREA : 24 m<sup>2</sup>

TERRACE AREA : 0 m<sup>2</sup>

TOTAL FLAT AREA : 24 m<sup>2</sup>



5TH FLOOR

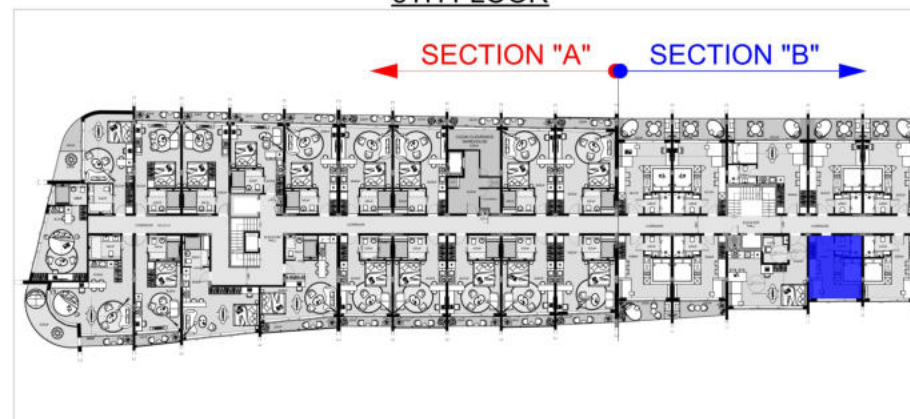

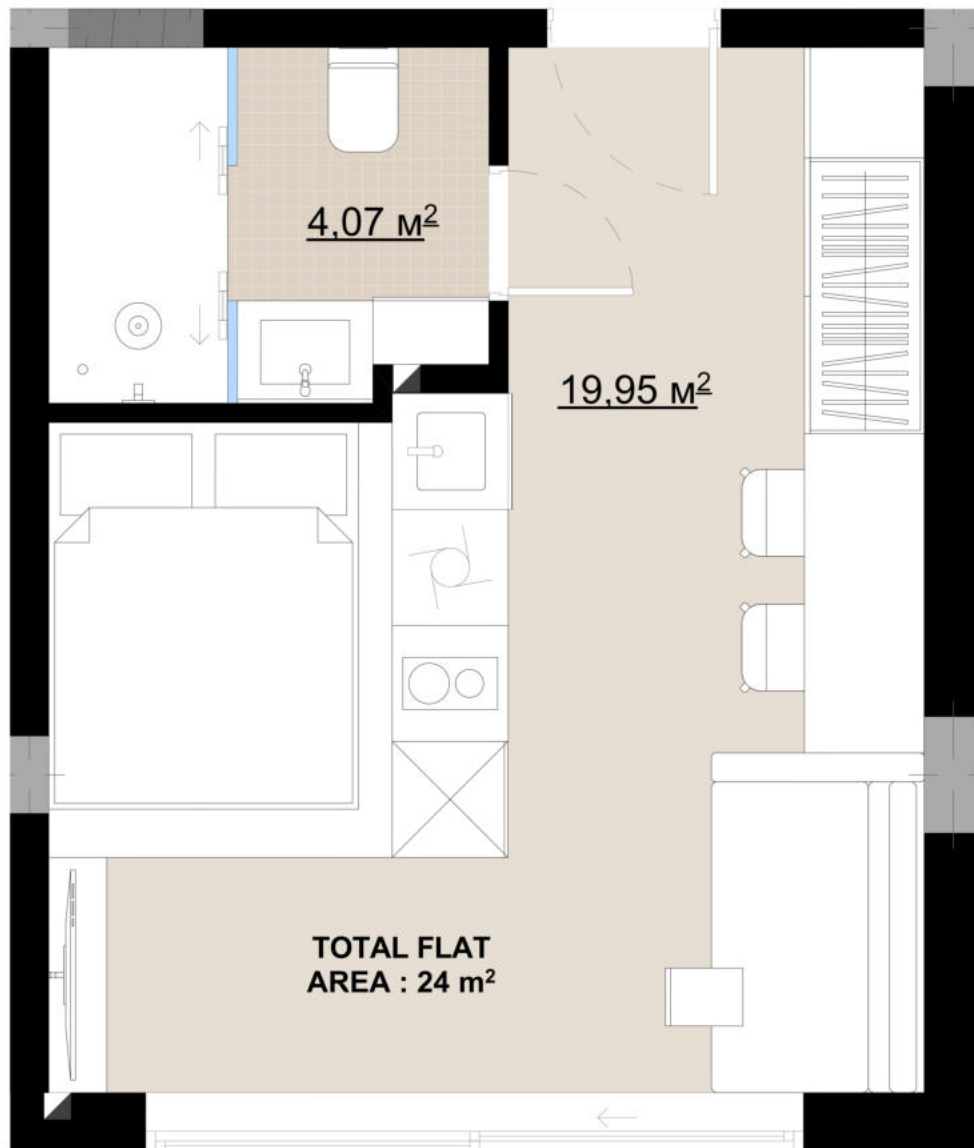

## SECTION "B"

UNIT 124

FLAT AREA : 24 m<sup>2</sup>

TERRACE AREA : 0 m<sup>2</sup>

TOTAL FLAT AREA : 24 m<sup>2</sup>



5TH FLOOR

SECTION "A" SECTION "B"

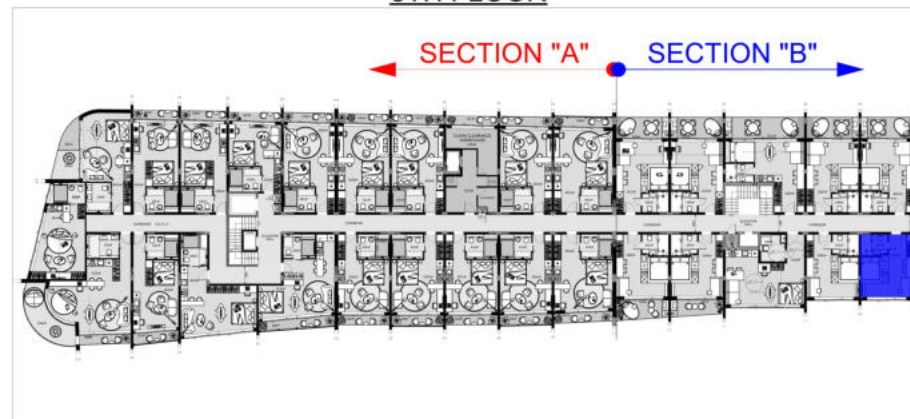

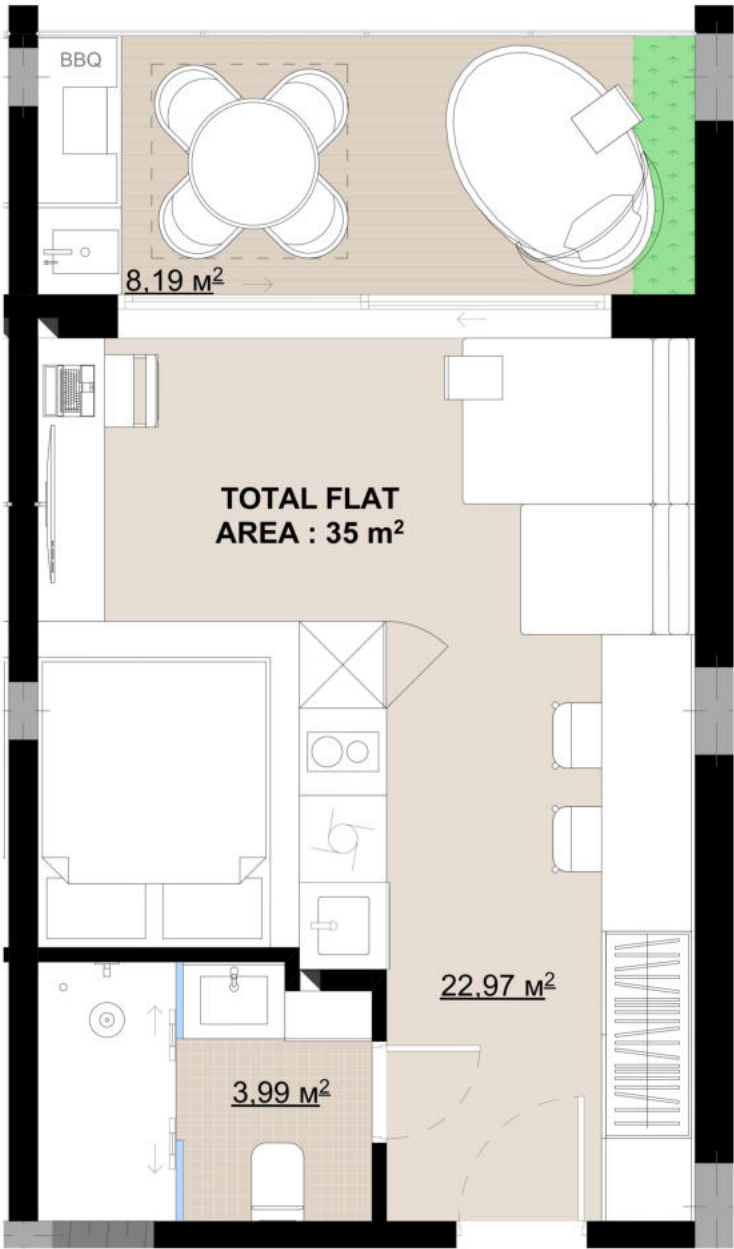

**SECTION "B"**

UNIT 123

FLAT AREA : 26,96 m<sup>2</sup>

TERRACE AREA : 8,19 m<sup>2</sup>

TOTAL FLAT AREA : 35 m<sup>2</sup>



5TH FLOOR

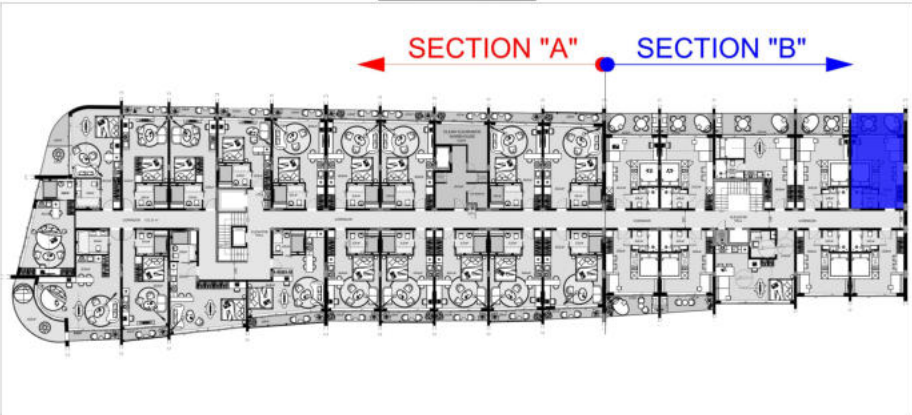

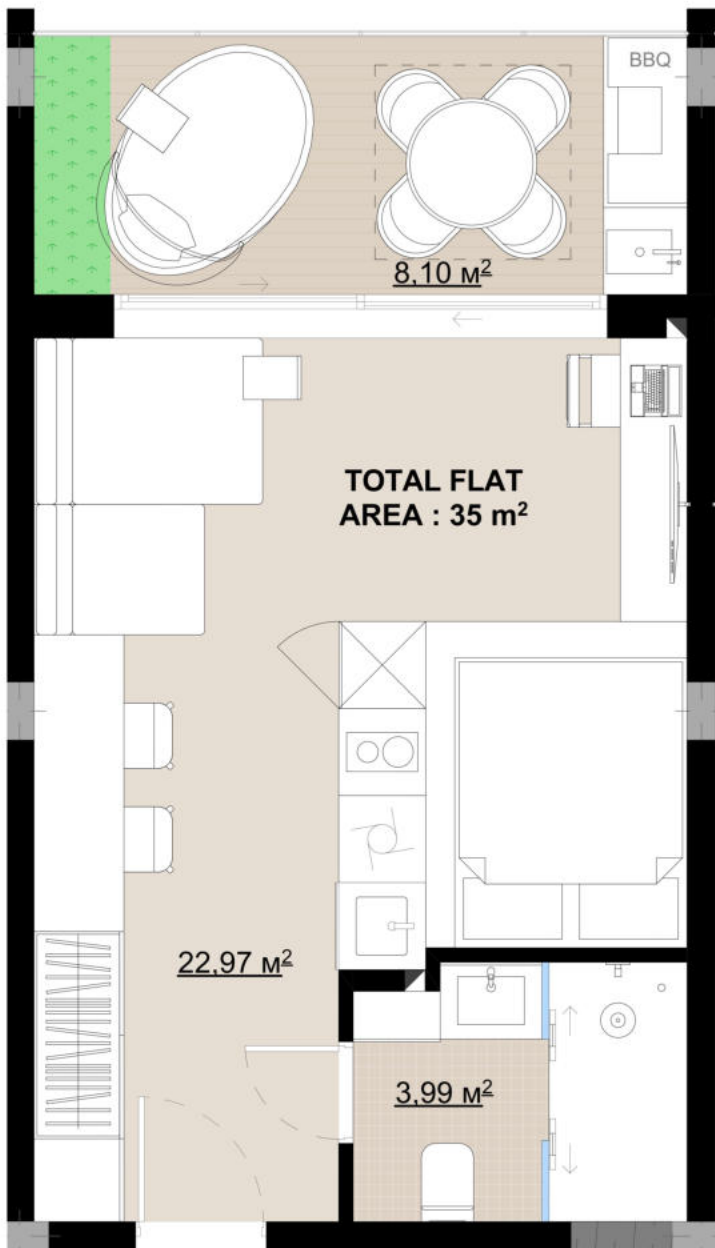

## SECTION "B"

UNIT 122

FLAT AREA : 26,96 m<sup>2</sup>

TERRACE AREA : 8,10 m<sup>2</sup>

TOTAL FLAT AREA : 35 m<sup>2</sup>



5TH FLOOR

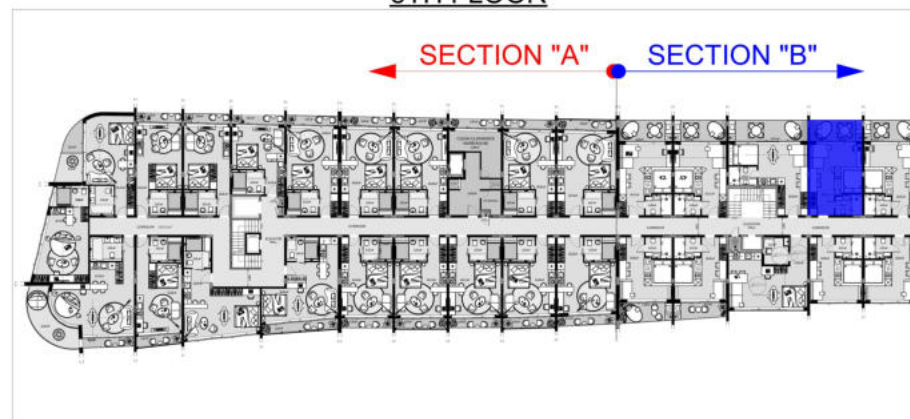

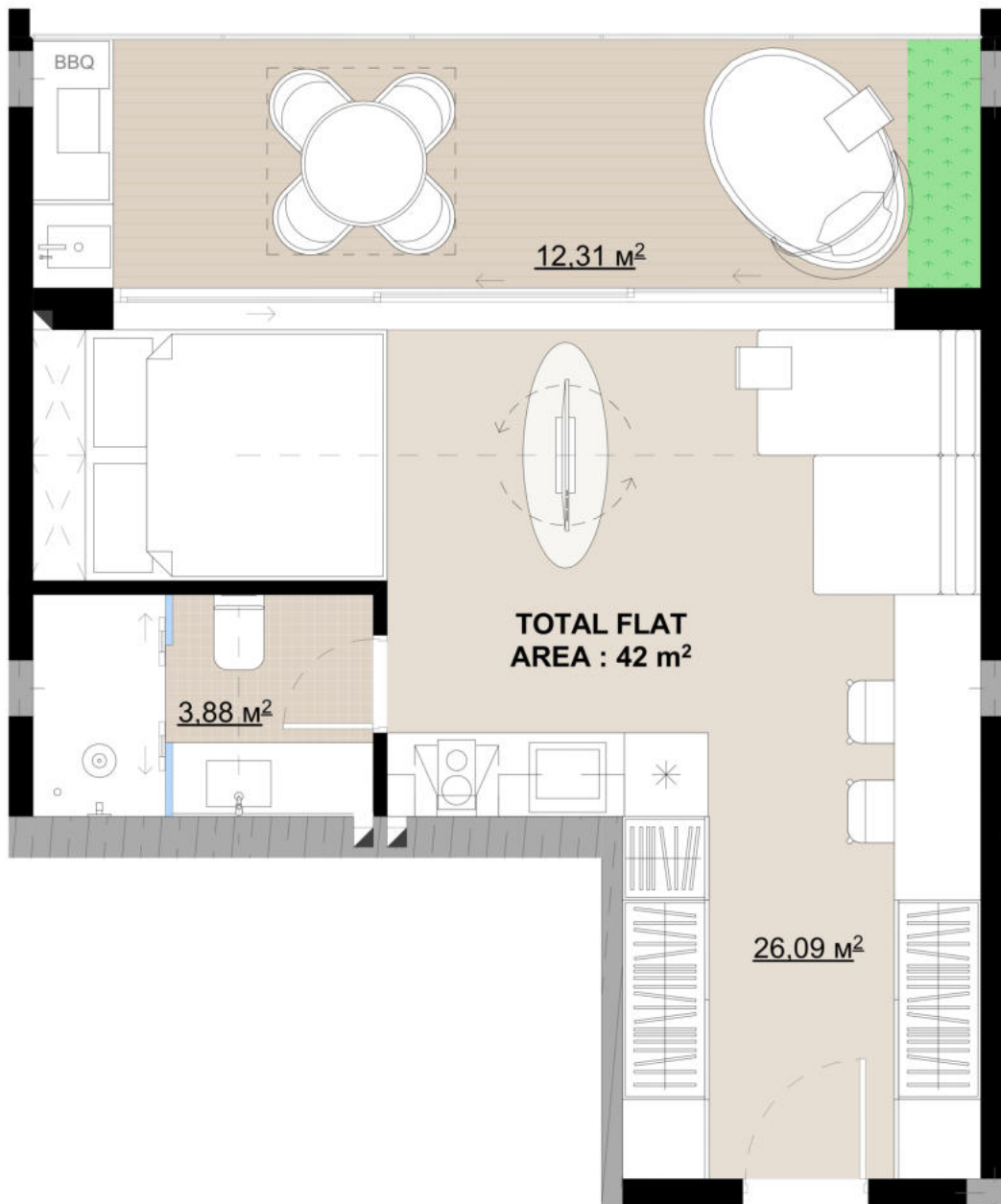

## SECTION "B"

UNIT 121

FLAT AREA : 29,97 m<sup>2</sup>

TERRACE AREA : 12,31 m<sup>2</sup>

TOTAL FLAT AREA : 42 m<sup>2</sup>



5TH FLOOR

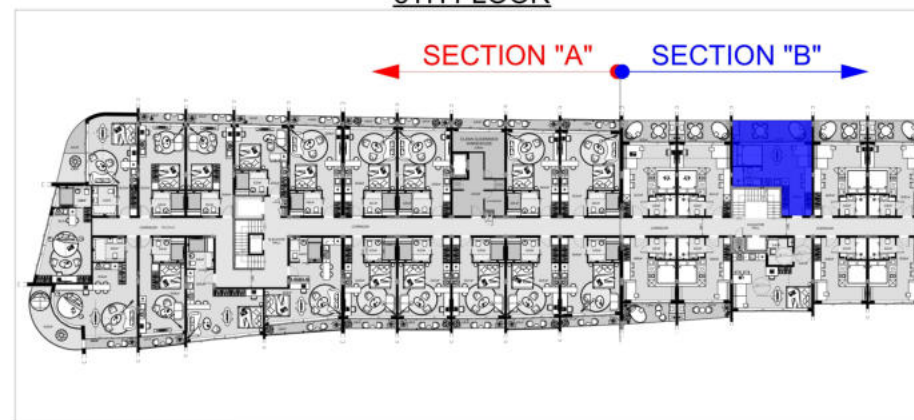

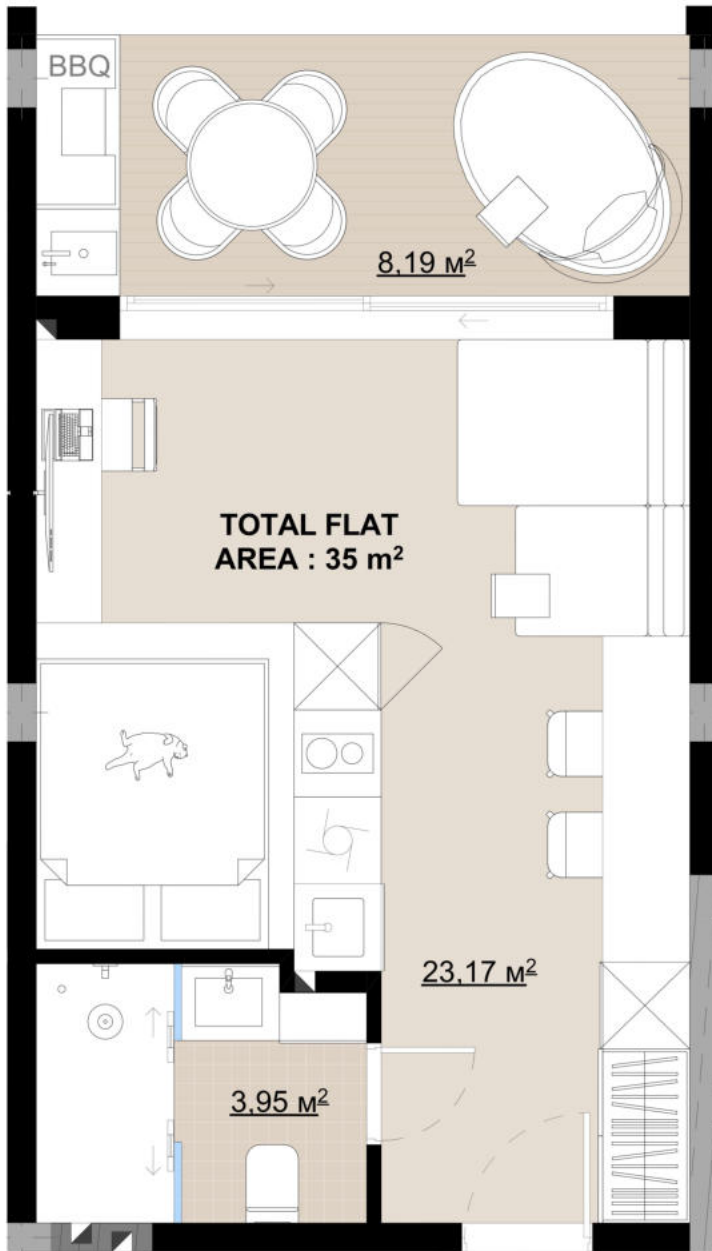

## SECTION "B"

UNIT 120

FLAT AREA : 27,12 m<sup>2</sup>

TERRACE AREA : 8,19 m<sup>2</sup>

TOTAL FLAT AREA : 35 m<sup>2</sup>



5TH FLOOR

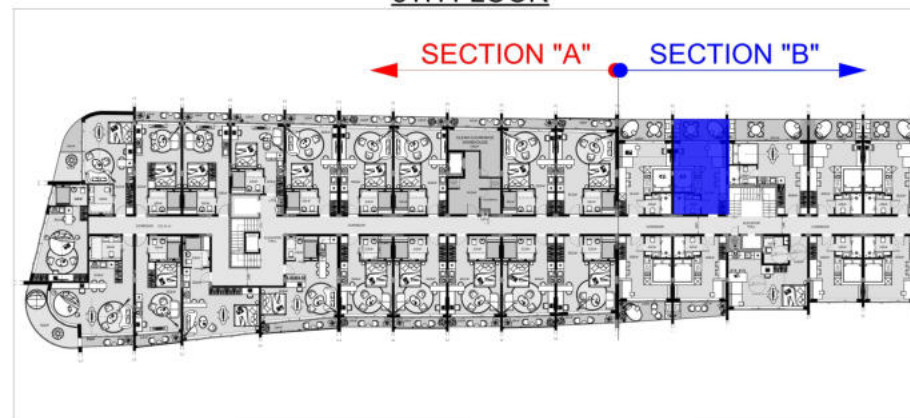

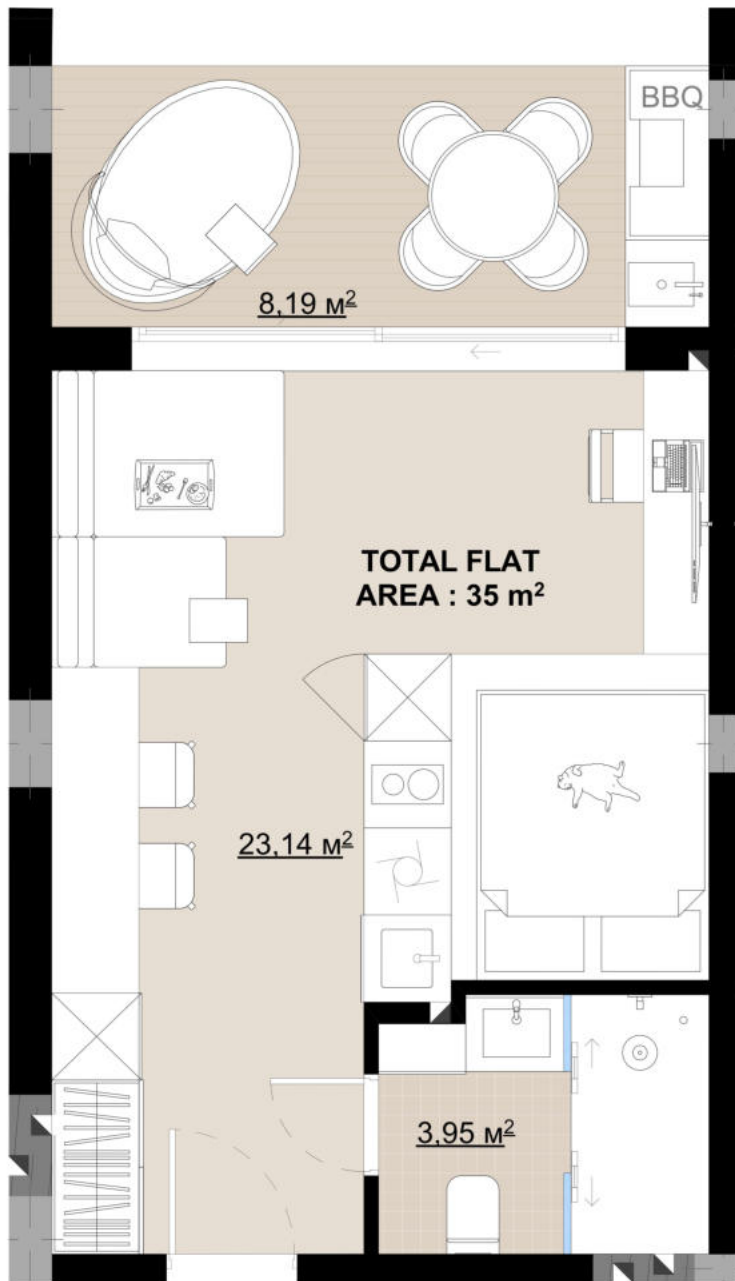

## SECTION "B"

UNIT 119

FLAT AREA : 27,12 m<sup>2</sup>

TERRACE AREA : 8,19 m<sup>2</sup>

TOTAL FLAT AREA : 35 m<sup>2</sup>



5TH FLOOR

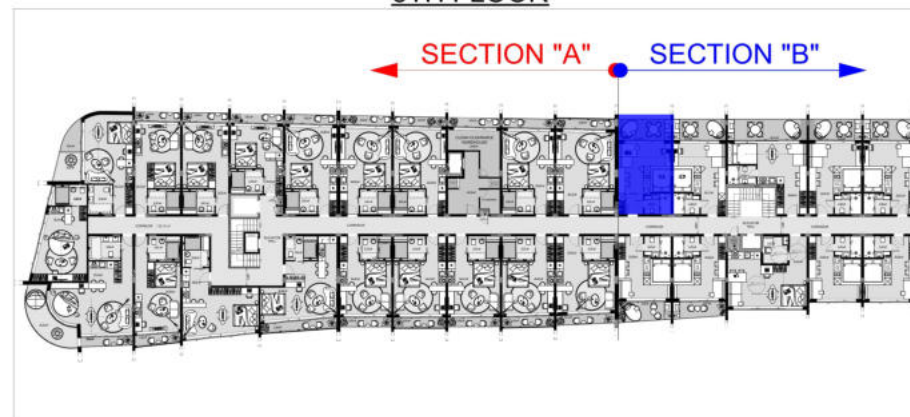

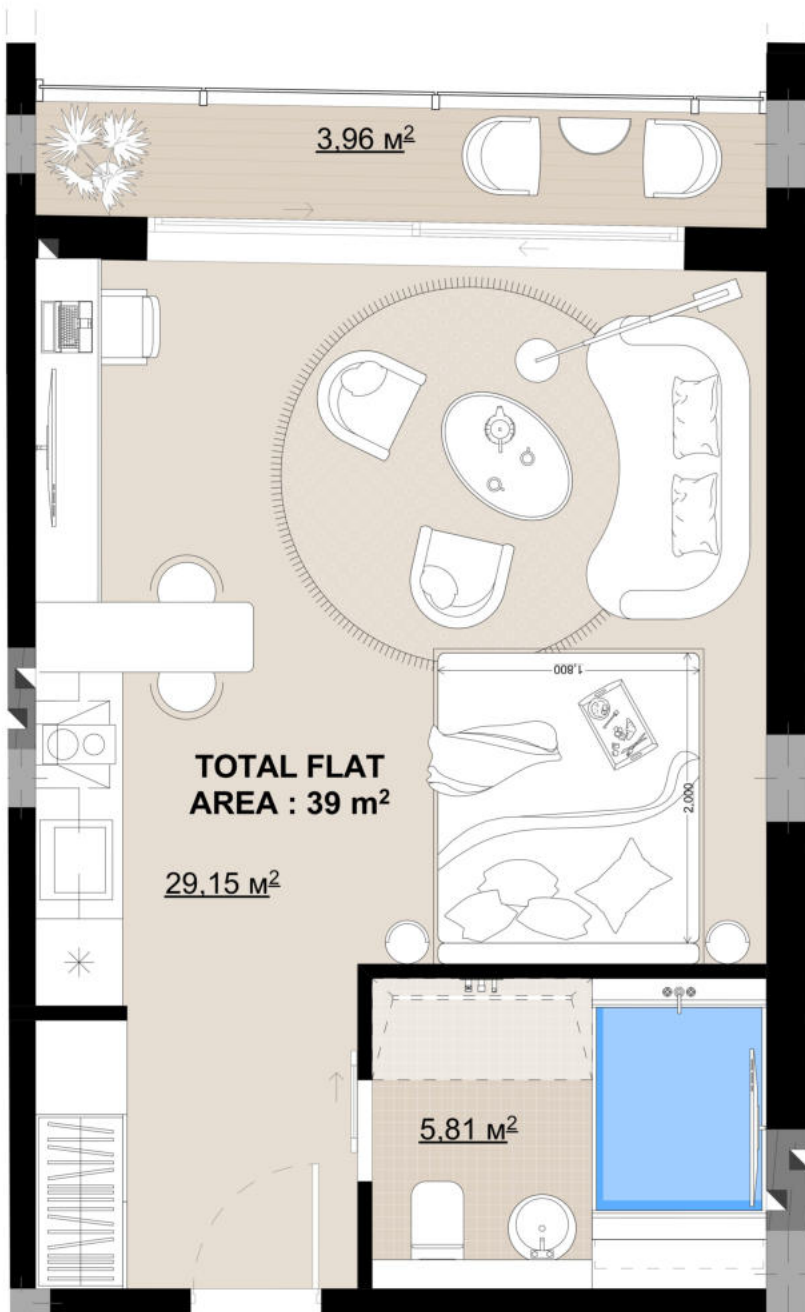

## SECTION "A"

UNIT 118

FLAT AREA : 34,96 m<sup>2</sup>

TERRACE AREA : 3.96 m<sup>2</sup>

TOTAL FLAT AREA : 39 m<sup>2</sup>



5TH FLOOR

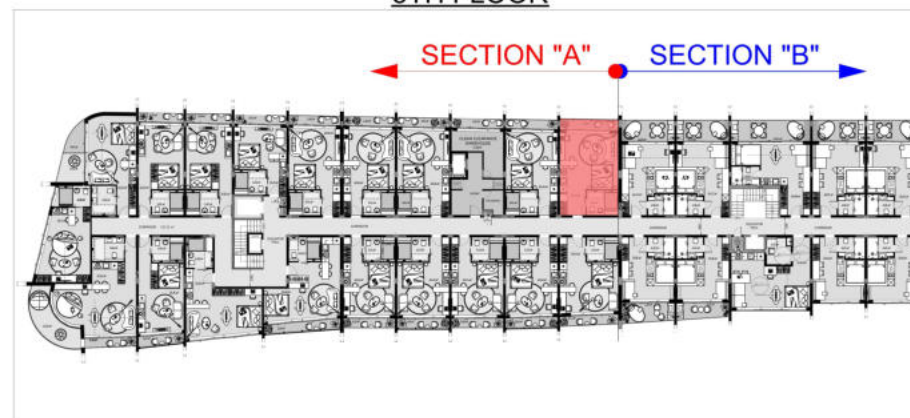

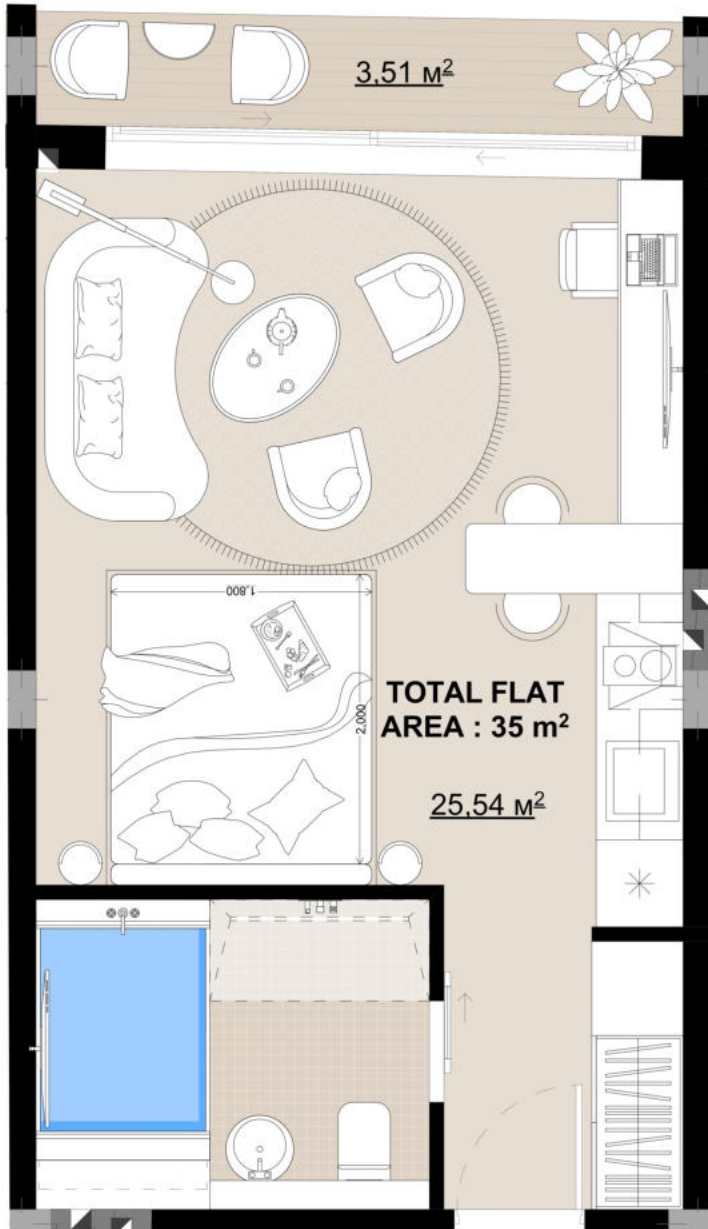

**SECTION "A"**

UNIT 117

FLAT AREA : 31.35 m<sup>2</sup>

TERRACE AREA : 3.51 m<sup>2</sup>

TOTAL FLAT AREA : 35 m<sup>2</sup>



5TH FLOOR

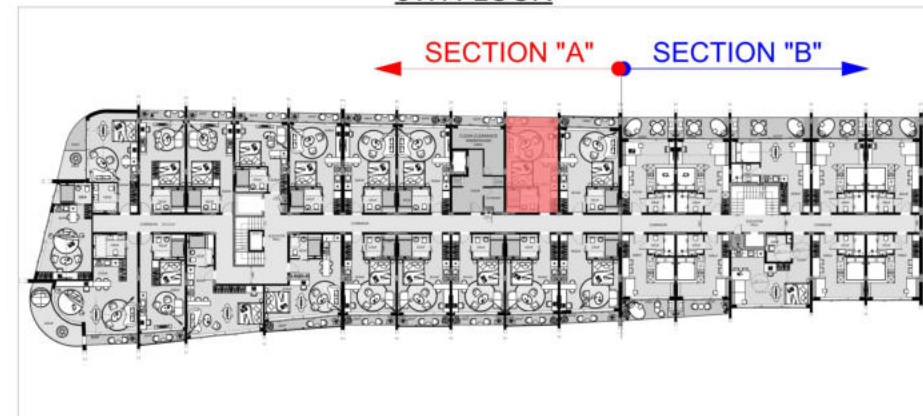

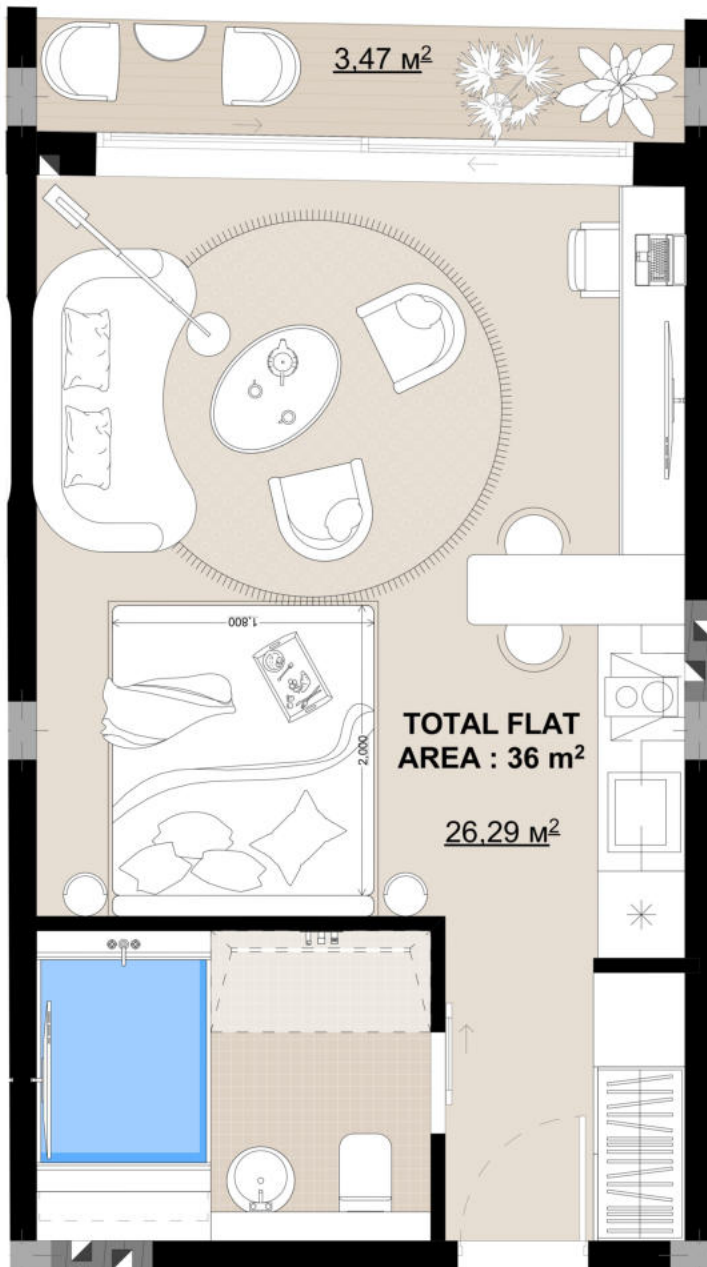

## SECTION "A"

UNIT 116

FLAT AREA : 32,1 m<sup>2</sup>

TERRACE AREA : 3,47 m<sup>2</sup>

TOTAL FLAT AREA : 36 m<sup>2</sup>



5TH FLOOR

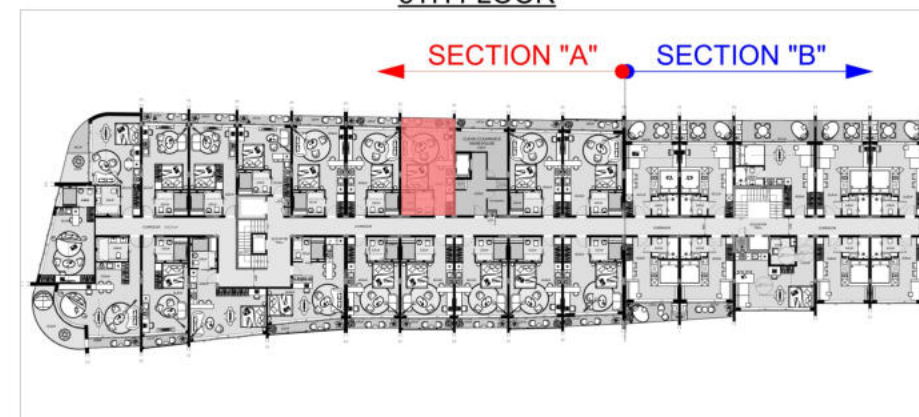

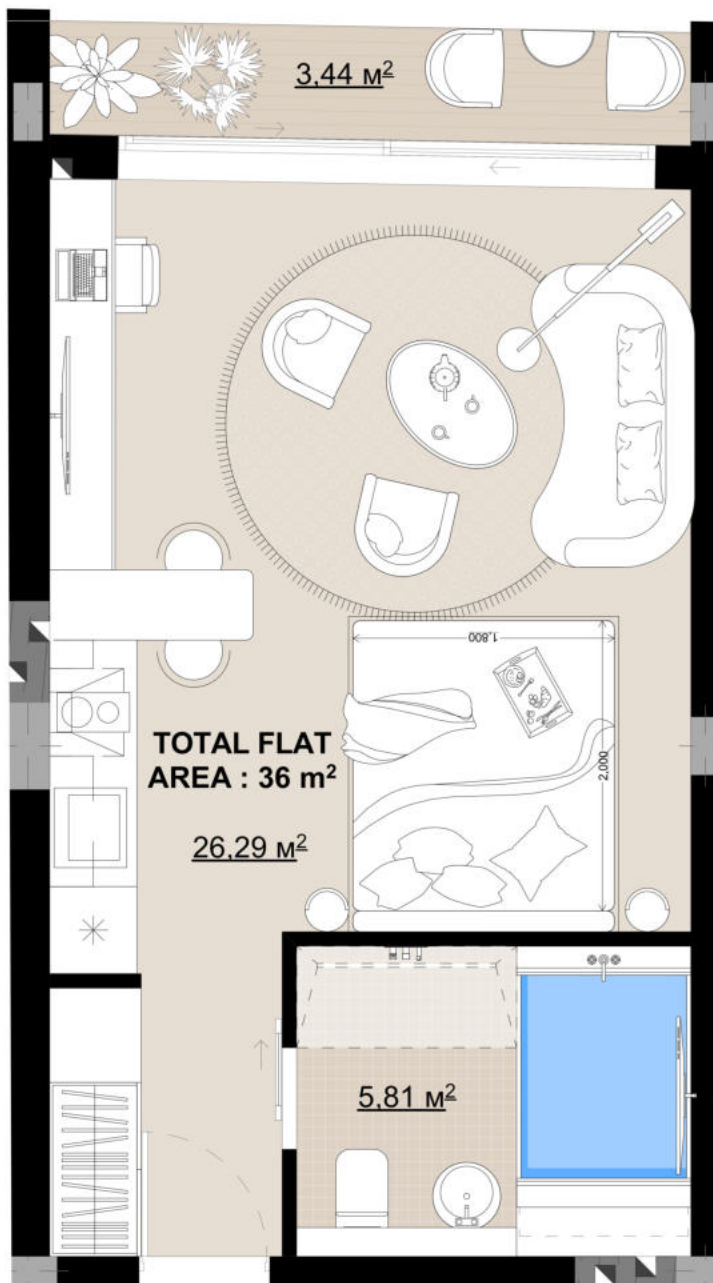

## SECTION "A"

UNIT 115

FLAT AREA : 32,1 m<sup>2</sup>

TERRACE AREA : 3,44 m<sup>2</sup>

TOTAL FLAT AREA : 36 m<sup>2</sup>



5TH FLOOR

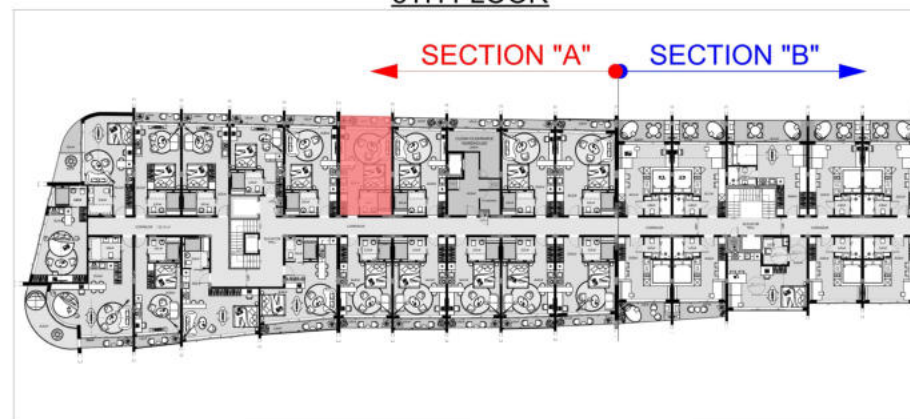

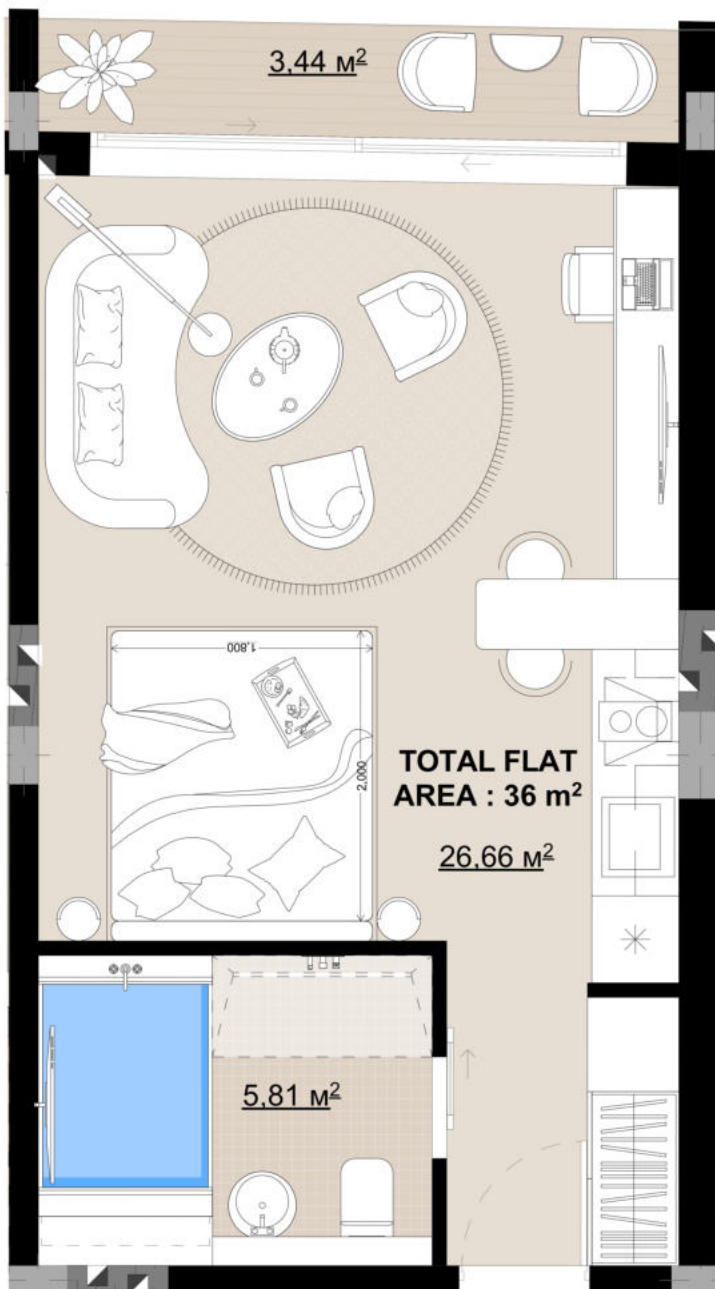

## SECTION "A"

UNIT 114

FLAT AREA : 32,47 m<sup>2</sup>

TERRACE AREA : 3,44 m<sup>2</sup>

TOTAL FLAT AREA : 36 m<sup>2</sup>



5TH FLOOR

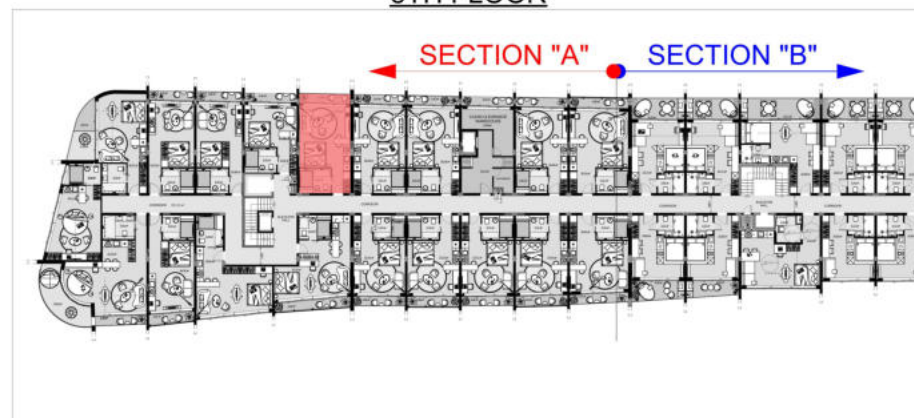

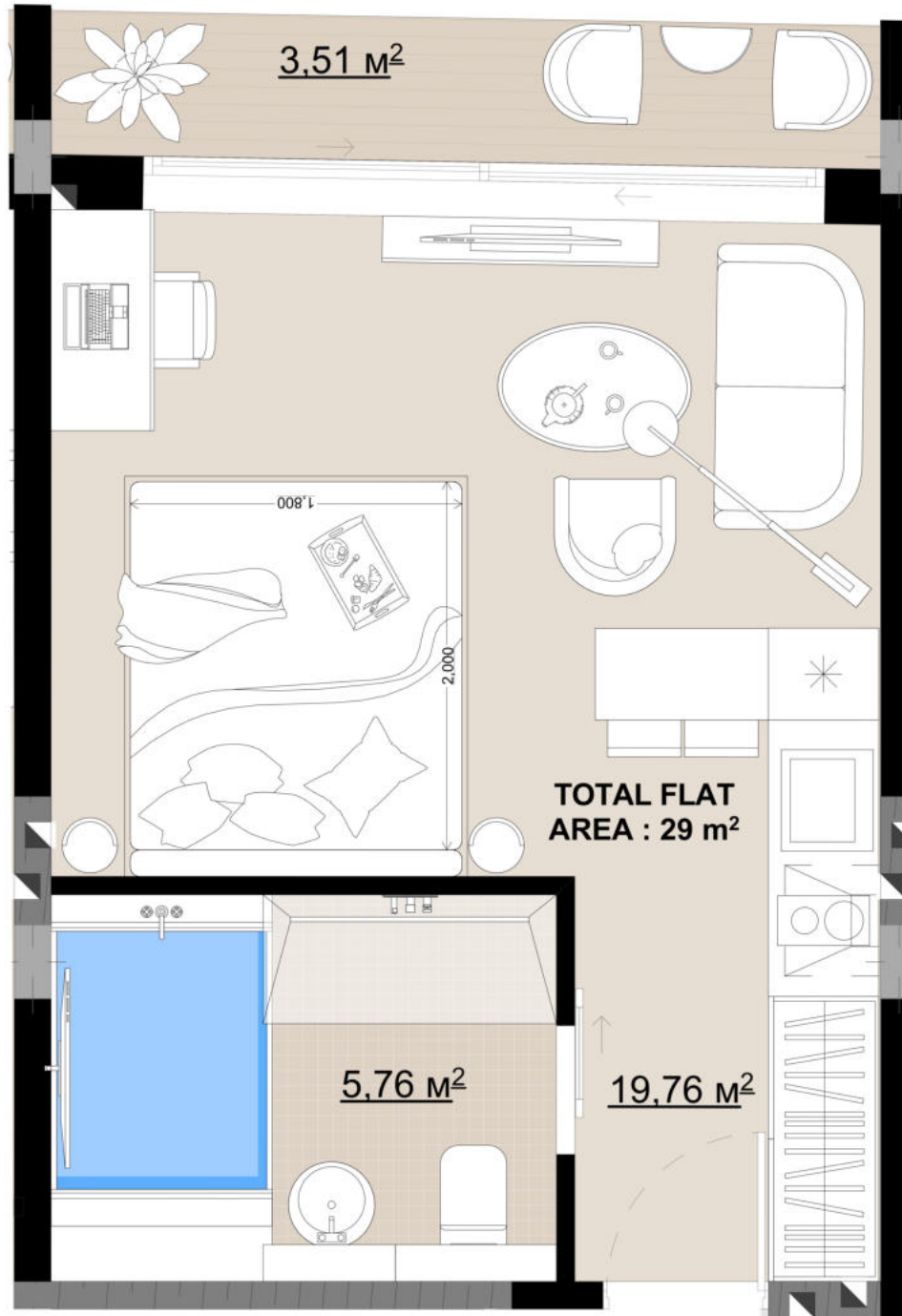

**SECTION "A"**

UNIT 113

FLAT AREA : 25.52 m<sup>2</sup>

TERRACE AREA : 3.51 m<sup>2</sup>

TOTAL FLAT AREA : 29 m<sup>2</sup>



5TH FLOOR

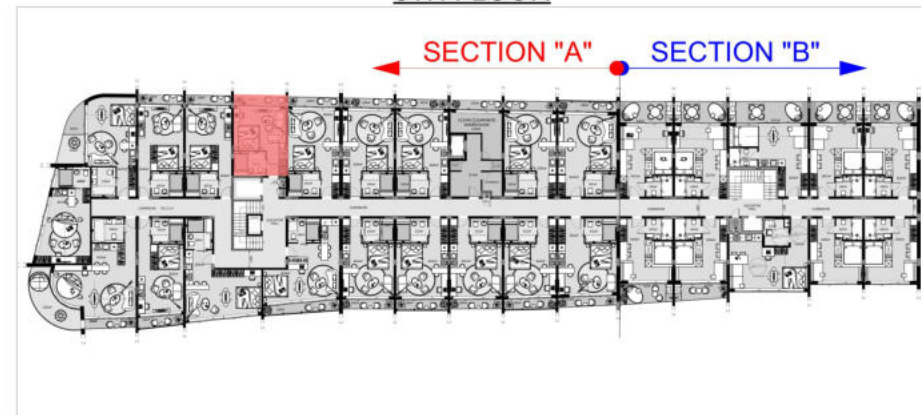

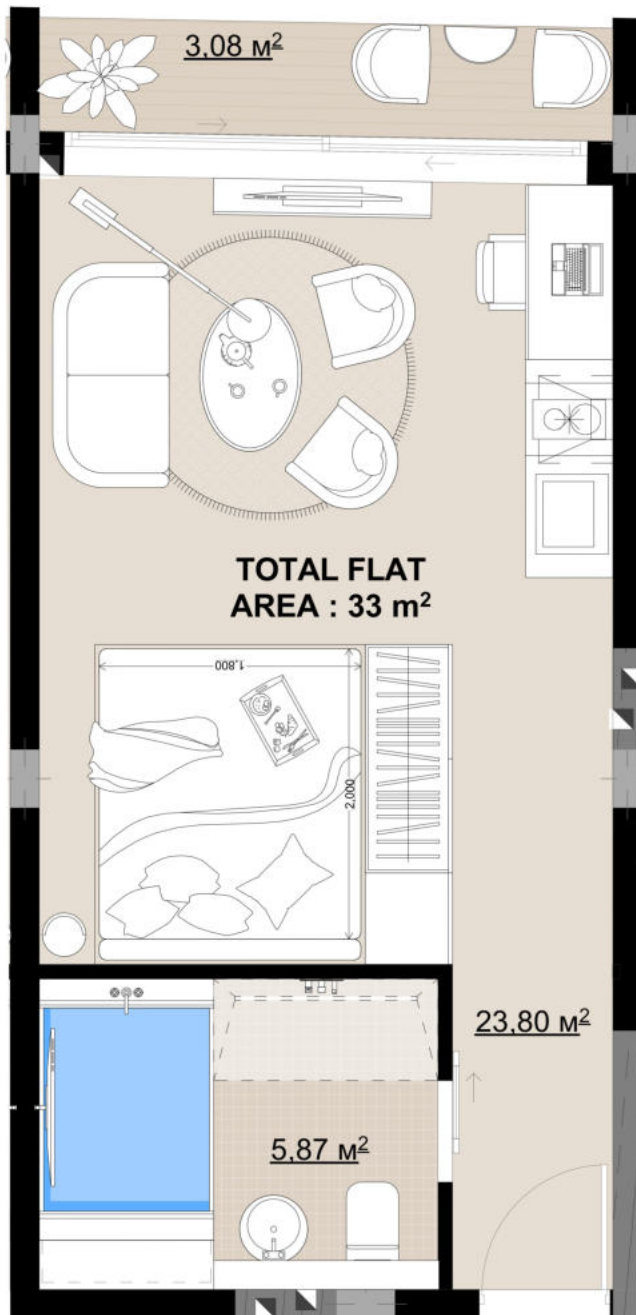

## SECTION "A"

UNIT 112

FLAT AREA : 29,67 m<sup>2</sup>

TERRACE AREA : 3,08 m<sup>2</sup>

TOTAL FLAT AREA : 33 m<sup>2</sup>



5TH FLOOR

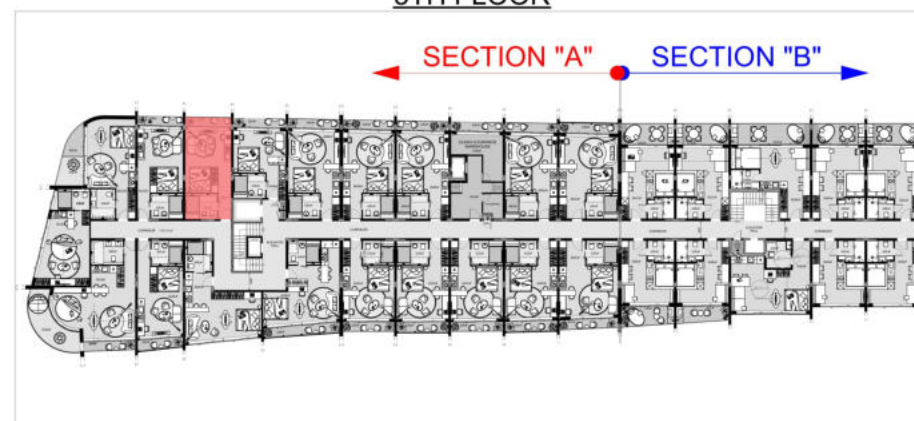

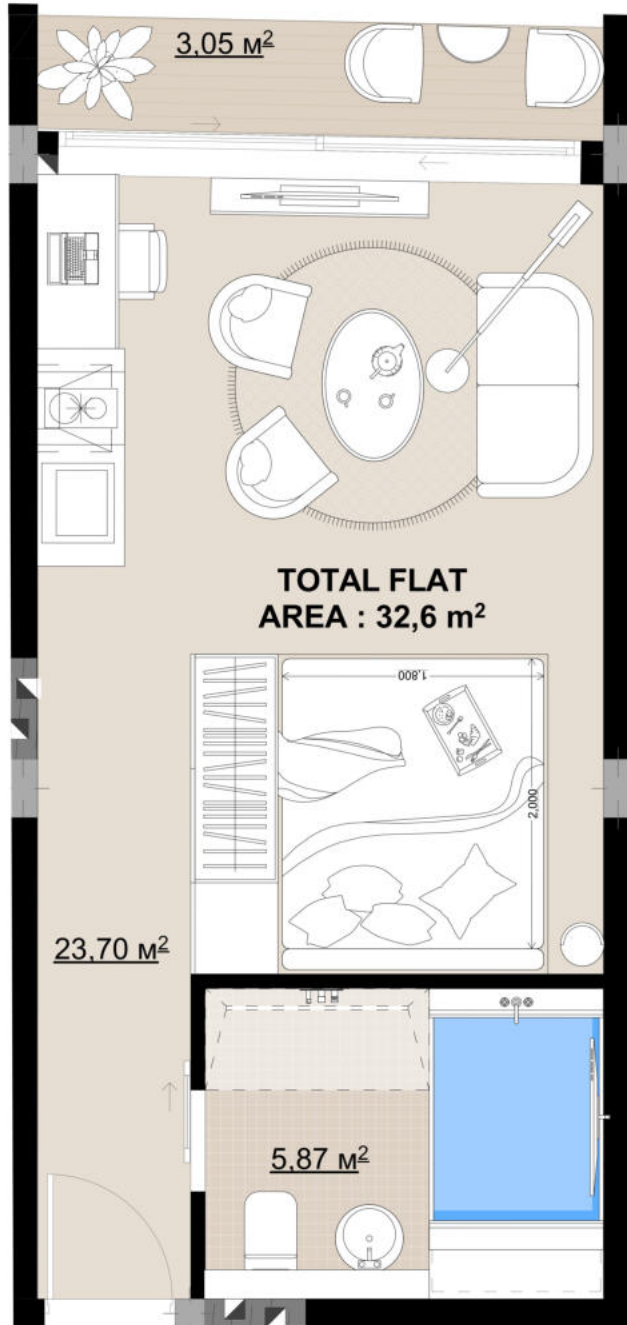

## SECTION "A"

UNIT 111

FLAT AREA : 29,57 m<sup>2</sup>

TERRACE AREA : 3.05 m<sup>2</sup>

TOTAL FLAT AREA : 32.6 m<sup>2</sup>



5TH FLOOR

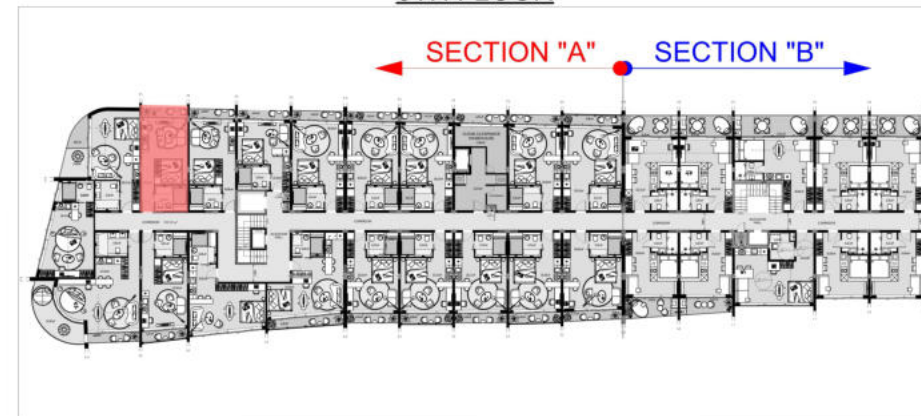

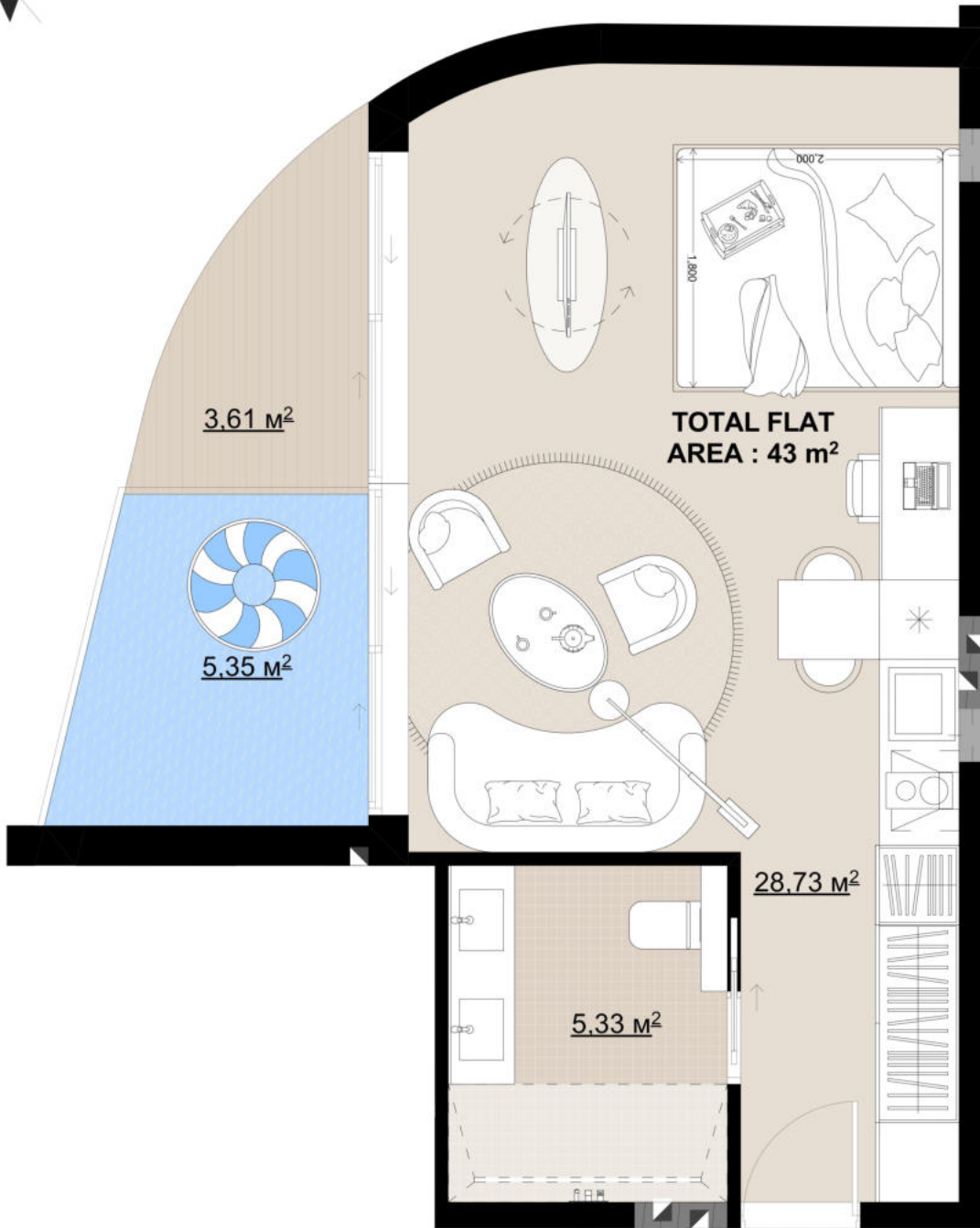

### SECTION "A"

UNIT 110

FLAT AREA : 34 m<sup>2</sup>

TERRACE AREA : 8,96 m<sup>2</sup>

TOTAL FLAT AREA : 43 m<sup>2</sup>



5TH FLOOR

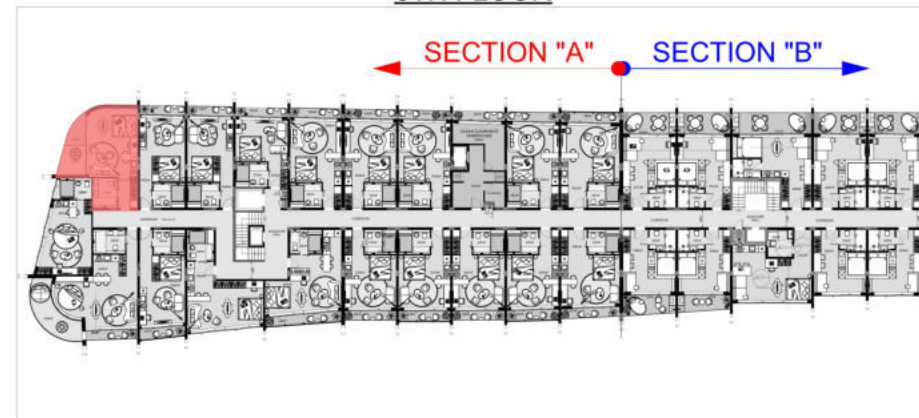

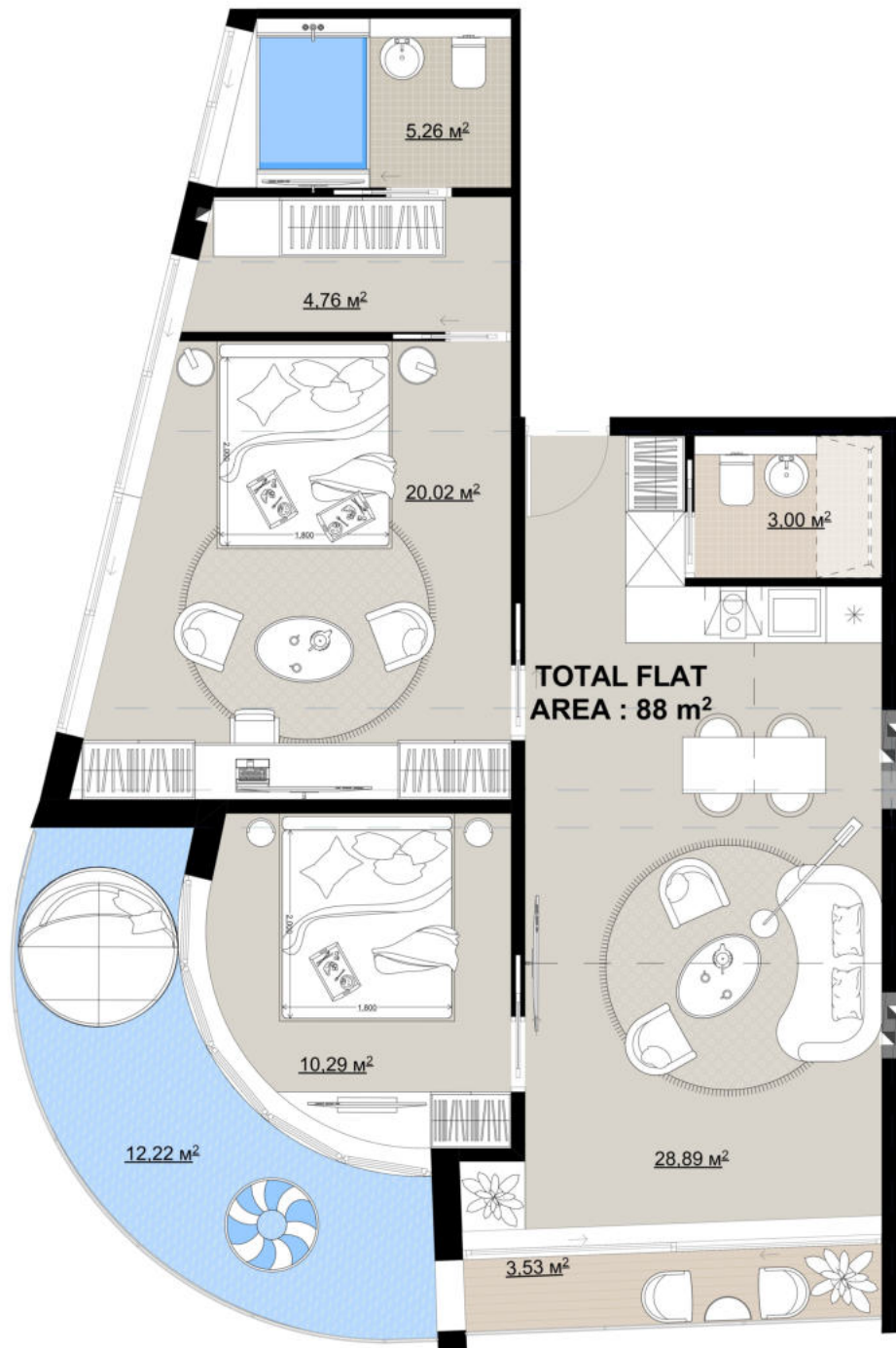

## SECTION "A"

UNIT 109

FLAT AREA : 72,22 m<sup>2</sup>

TERRACE AREA : 15,75 m<sup>2</sup>

TOTAL FLAT AREA : 88 m<sup>2</sup>



4TH FLOOR

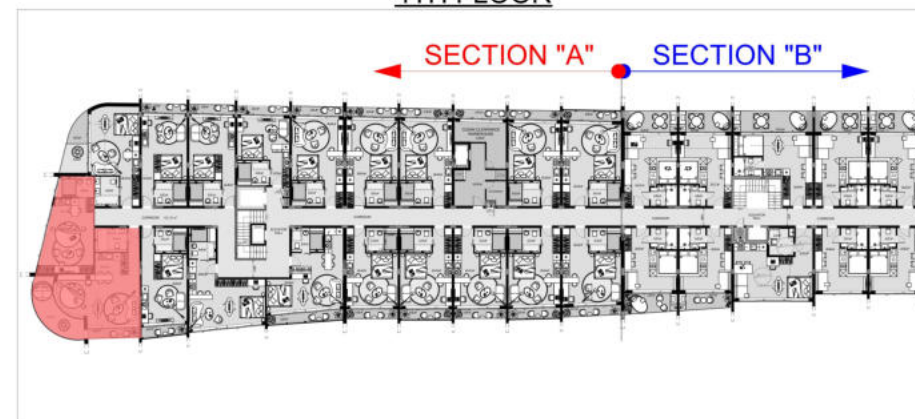

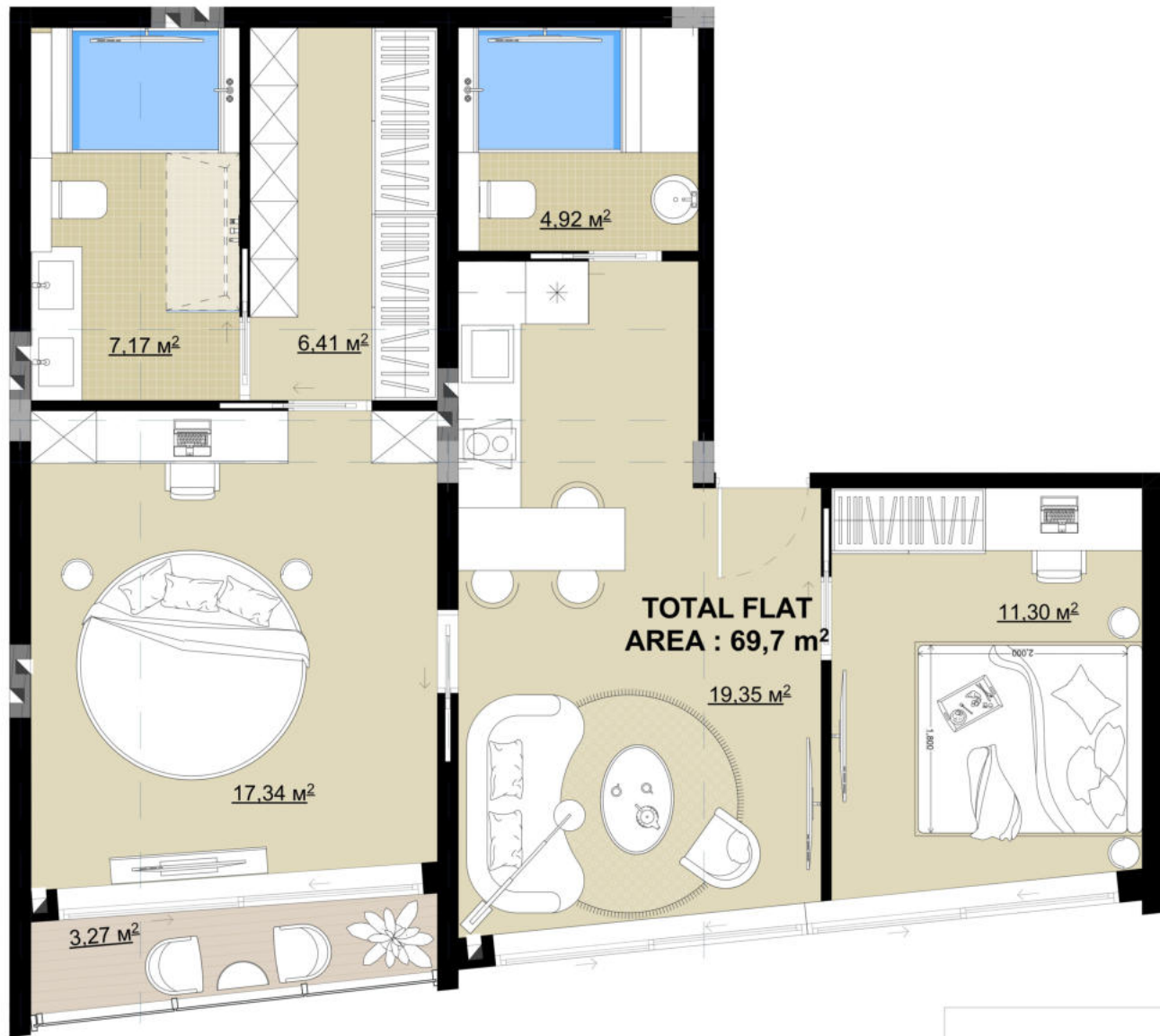

### SECTION "A"

UNIT 108

FLAT AREA : 66,5 m<sup>2</sup>

TERRACE AREA : 3,27 m<sup>2</sup>

TOTAL FLAT AREA : 69,7 m<sup>2</sup>



4TH FLOOR

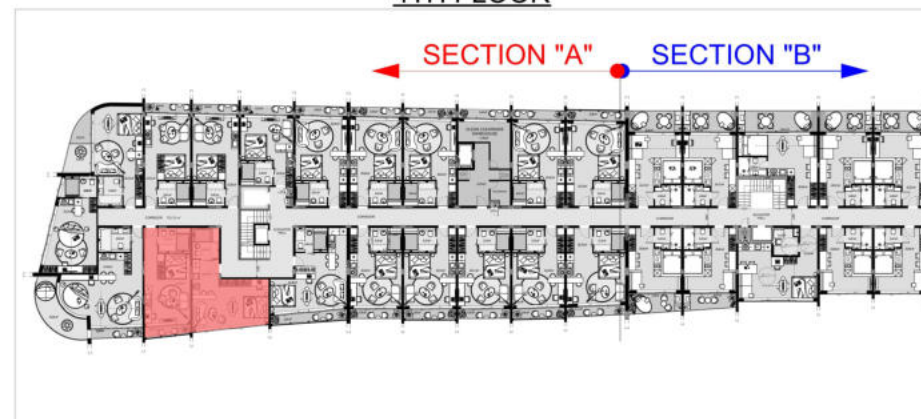

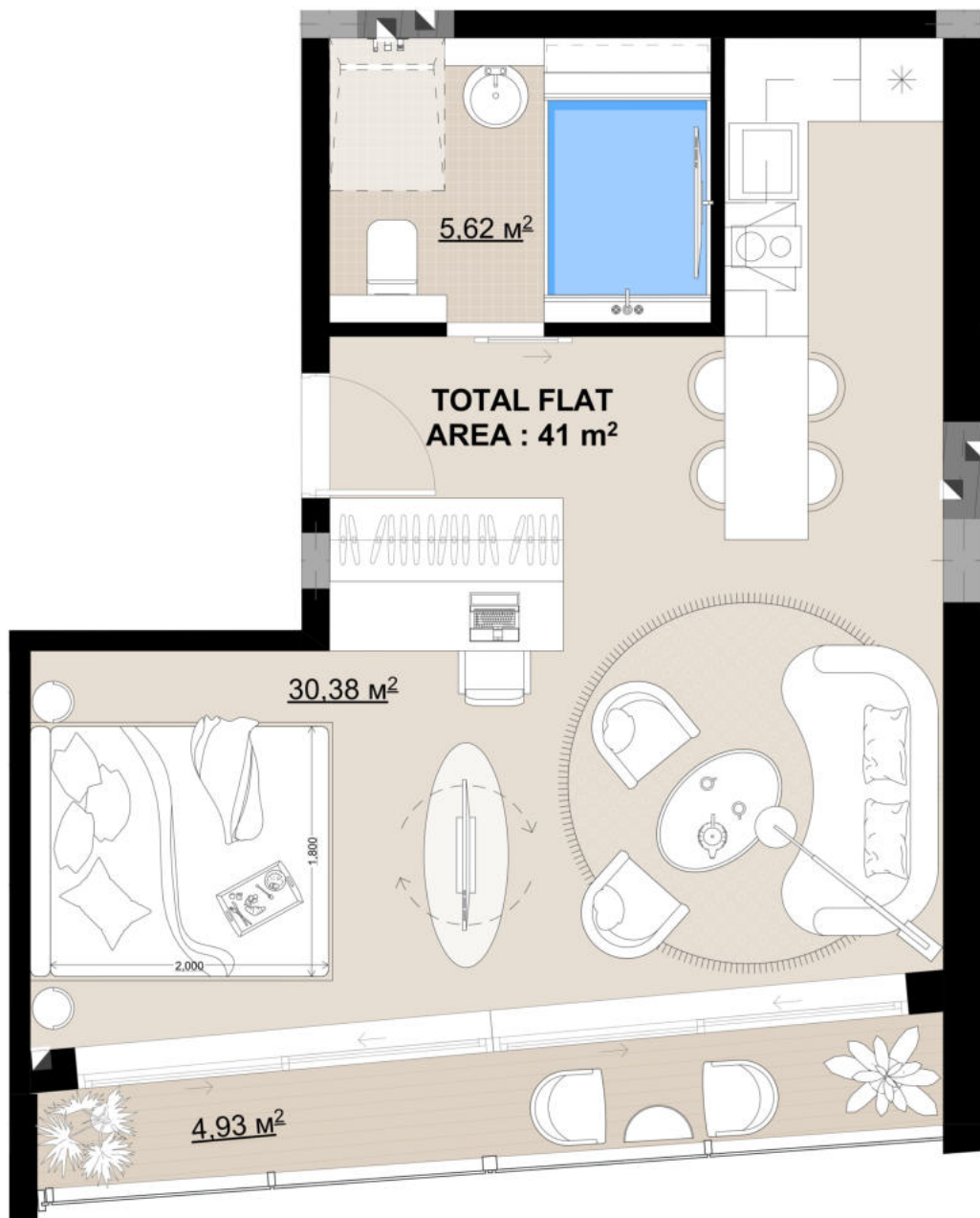

## SECTION "A"

UNIT 107

FLAT AREA : 36 m<sup>2</sup>

TERRACE AREA : 4,93 m<sup>2</sup>

TOTAL FLAT AREA : 41 m<sup>2</sup>



4TH FLOOR

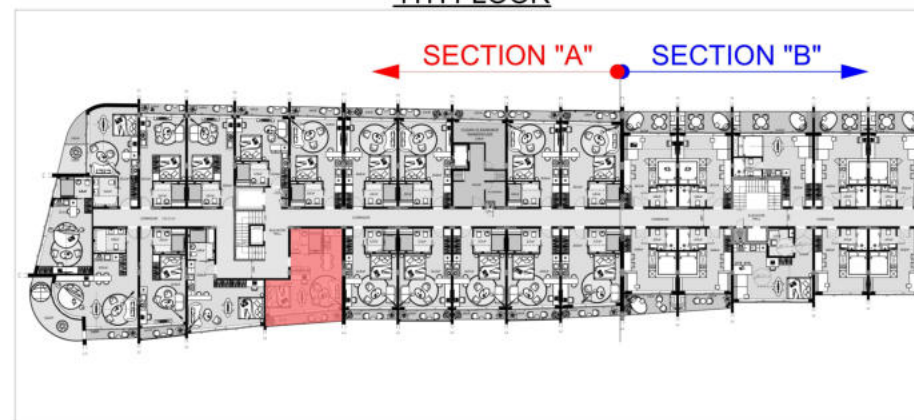

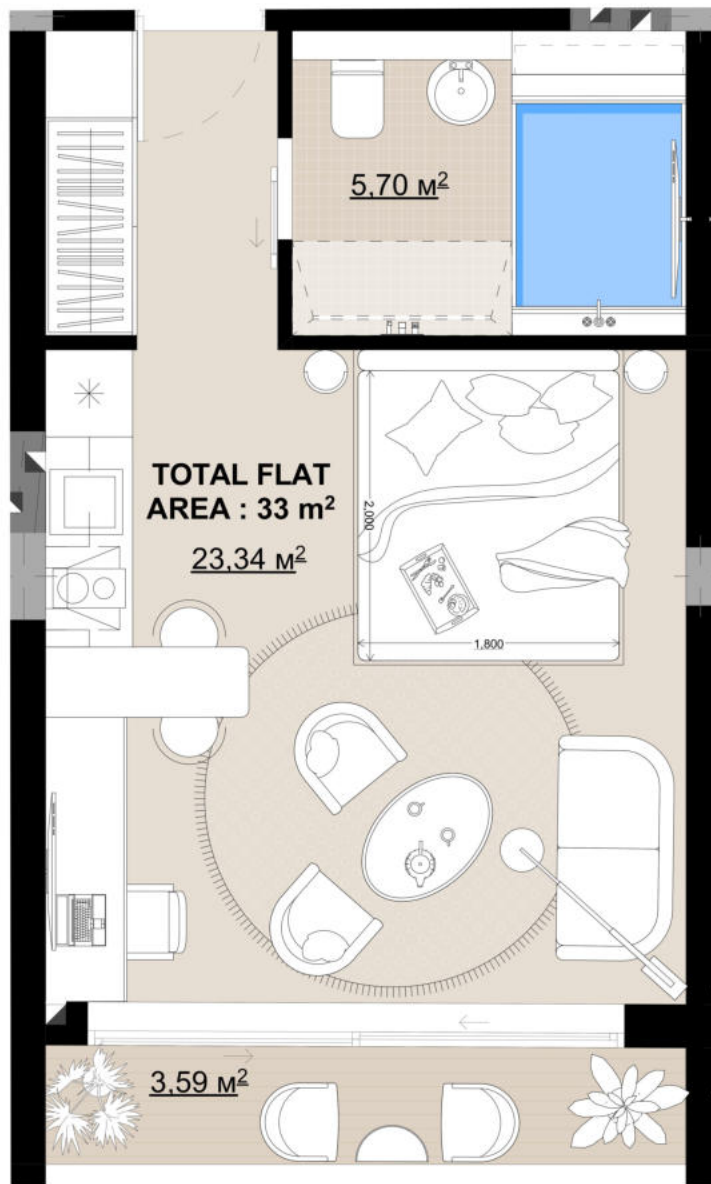

## SECTION "A"

UNIT 106

FLAT AREA : 29,04 m<sup>2</sup>

TERRACE AREA : 3,59 m<sup>2</sup>

TOTAL FLAT AREA : 33 m<sup>2</sup>



4TH FLOOR

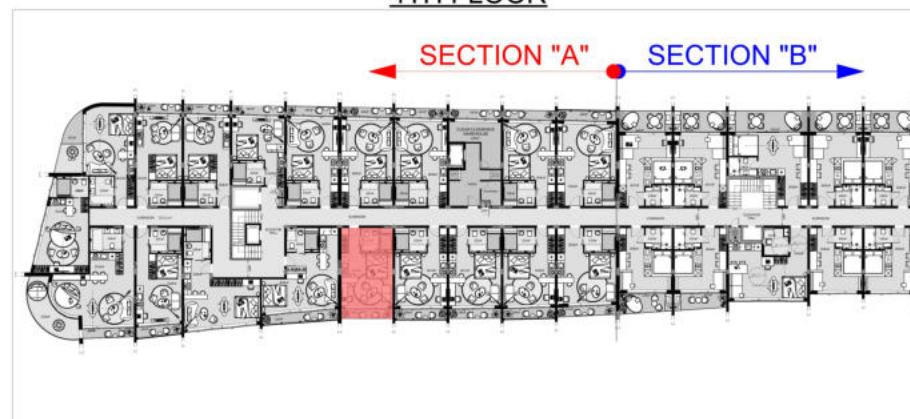

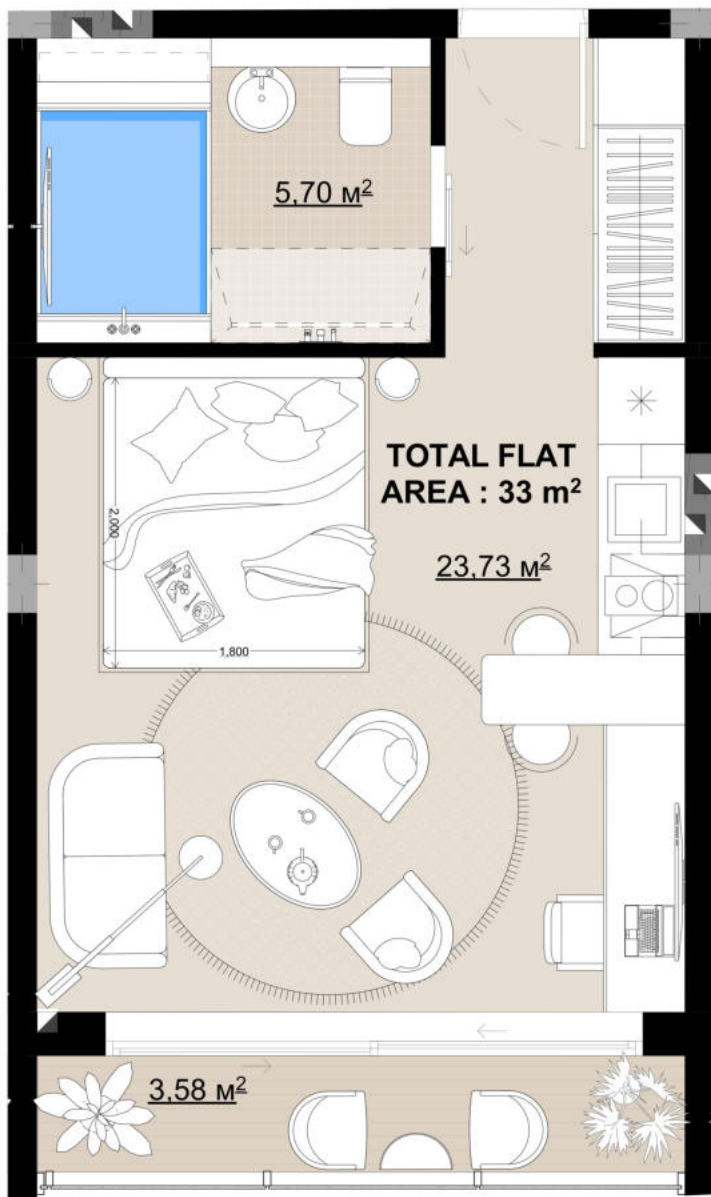

### SECTION "A"

UNIT 105

FLAT AREA : 29,43 m<sup>2</sup>

TERRACE AREA : 3,58 m<sup>2</sup>

TOTAL FLAT AREA : 33 m<sup>2</sup>



4TH FLOOR

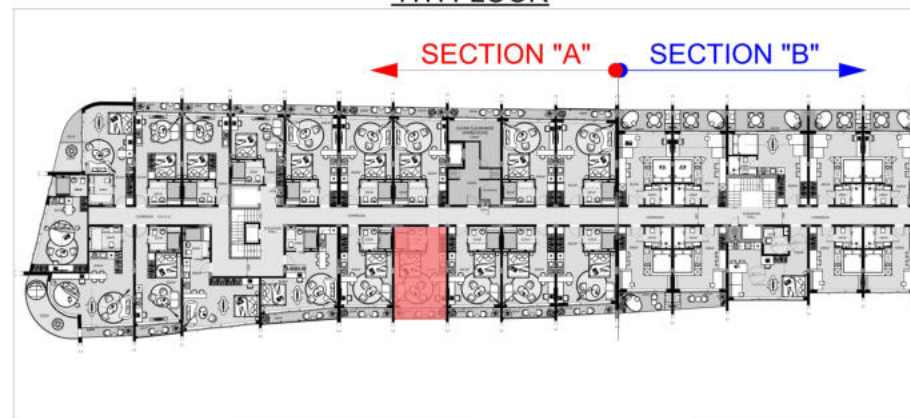

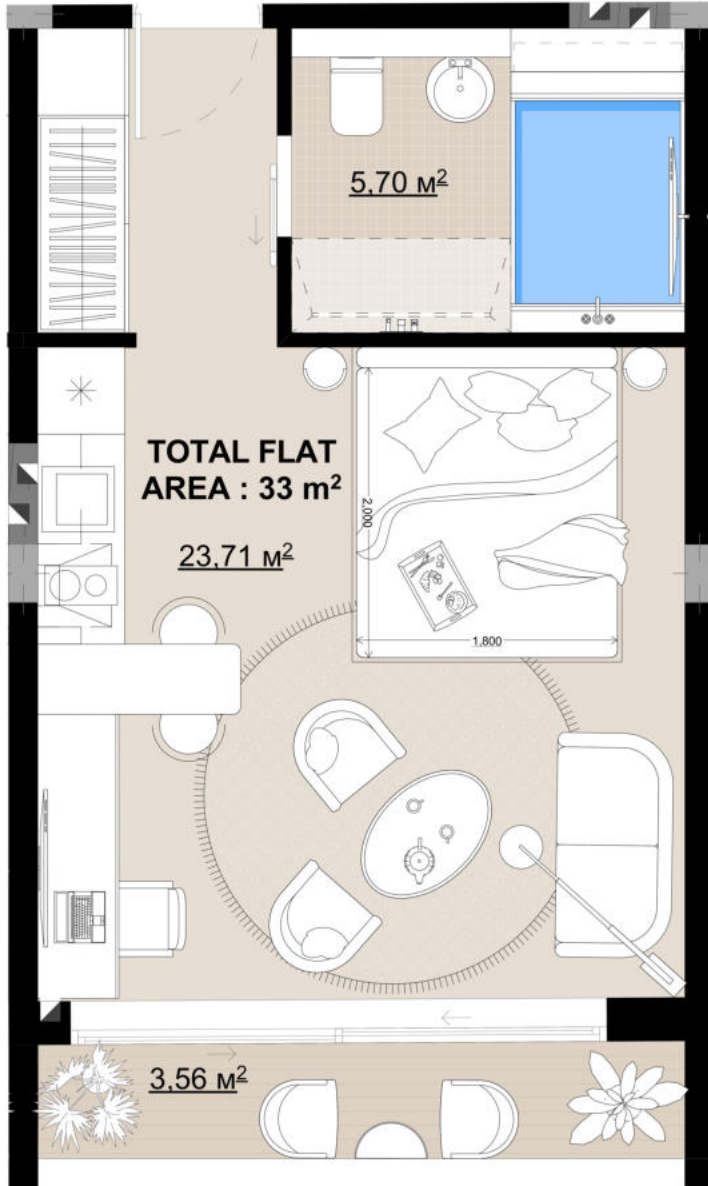

**SECTION "A"**

**UNIT 104**

**FLAT AREA : 29,41 m<sup>2</sup>**

**TERRACE AREA : 3,56 m<sup>2</sup>**

**TOTAL FLAT AREA : 33 m<sup>2</sup>**



**4TH FLOOR**

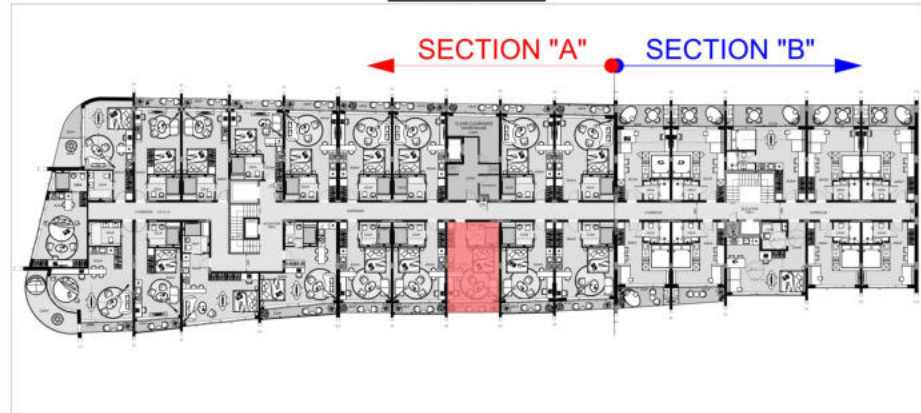

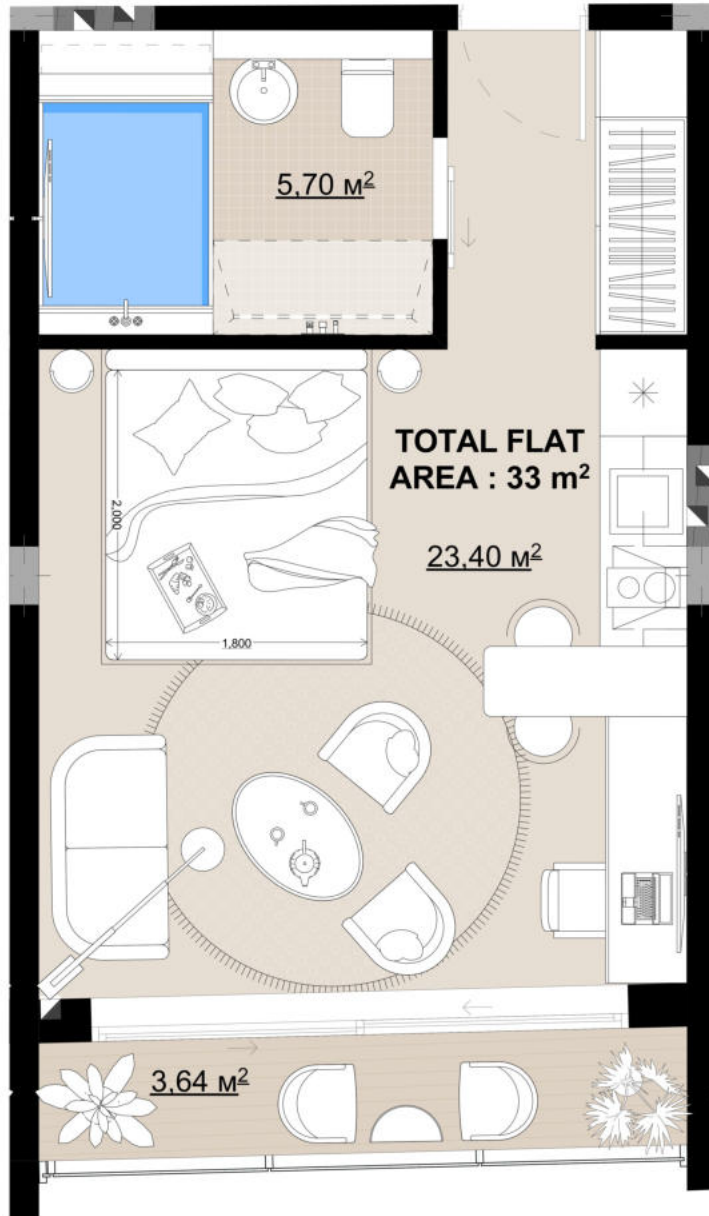

## SECTION "A"

UNIT 103

FLAT AREA : 29,1 m<sup>2</sup>

TERRACE AREA : 3,64 m<sup>2</sup>

TOTAL FLAT AREA : 33 m<sup>2</sup>



4TH FLOOR

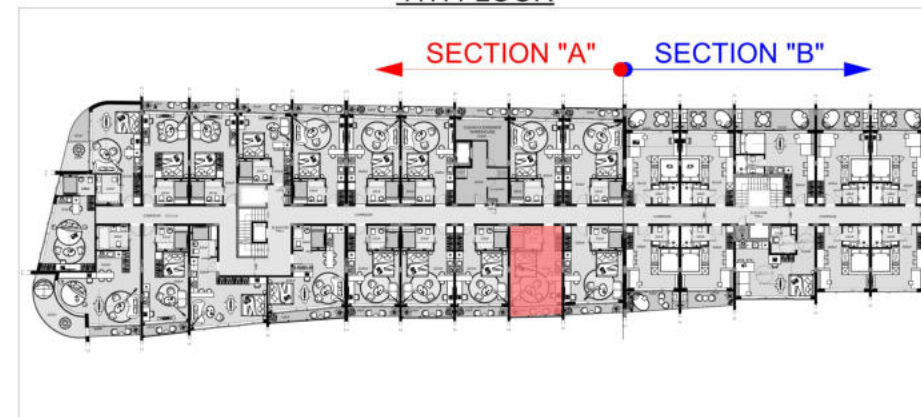

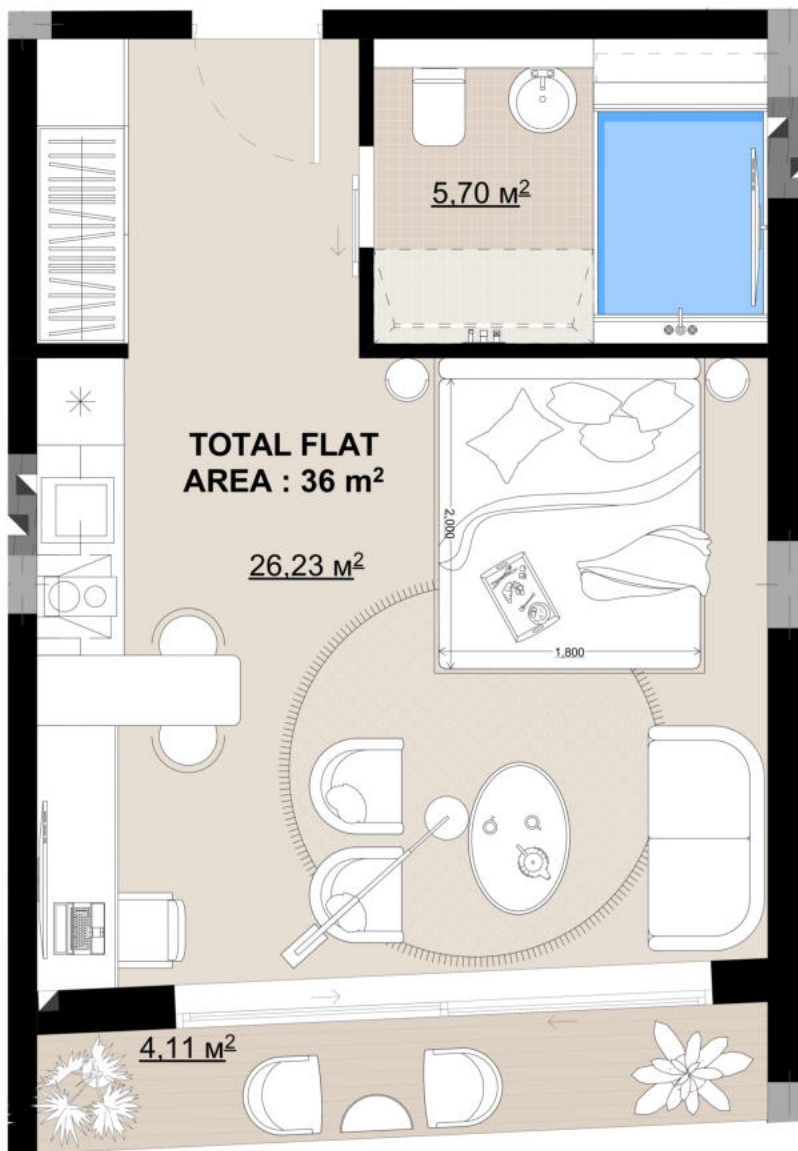

## SECTION "A"

UNIT 102

FLAT AREA : 31.93 m<sup>2</sup>

TERRACE AREA : 4,11 m<sup>2</sup>

TOTAL FLAT AREA : 36 m<sup>2</sup>



4TH FLOOR

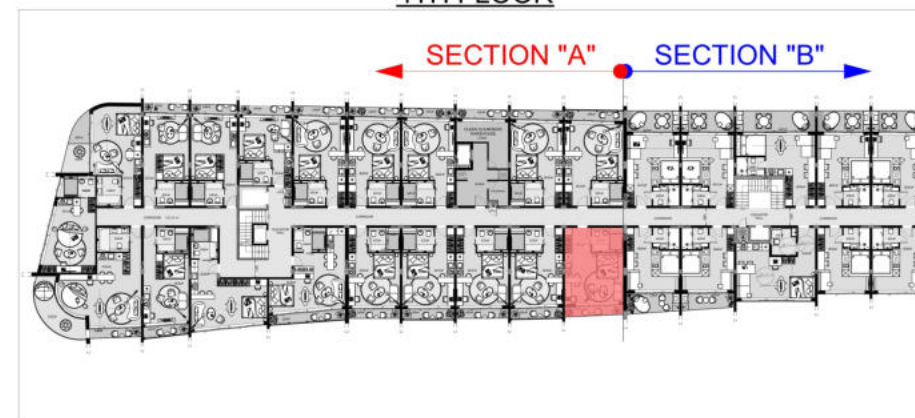



## SECTION "B"

UNIT 101

FLAT AREA : 23,68 m<sup>2</sup>

TERRACE AREA : 7,49 m<sup>2</sup>

TOTAL FLAT AREA : 32 m<sup>2</sup>

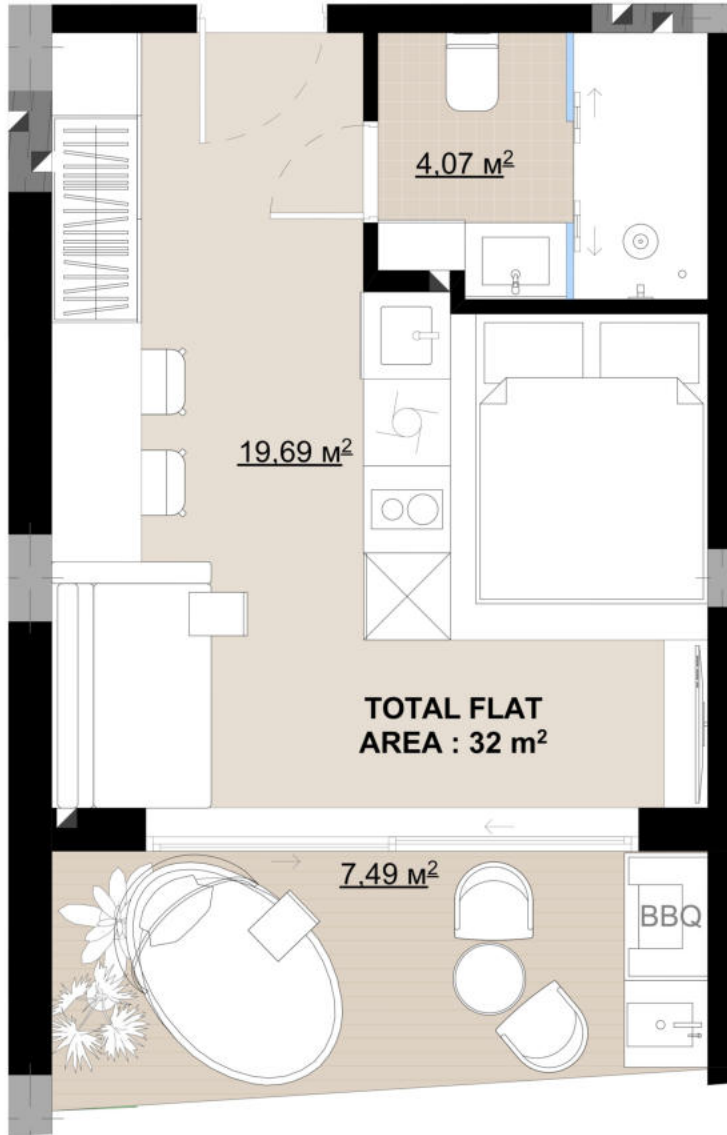

4TH FLOOR

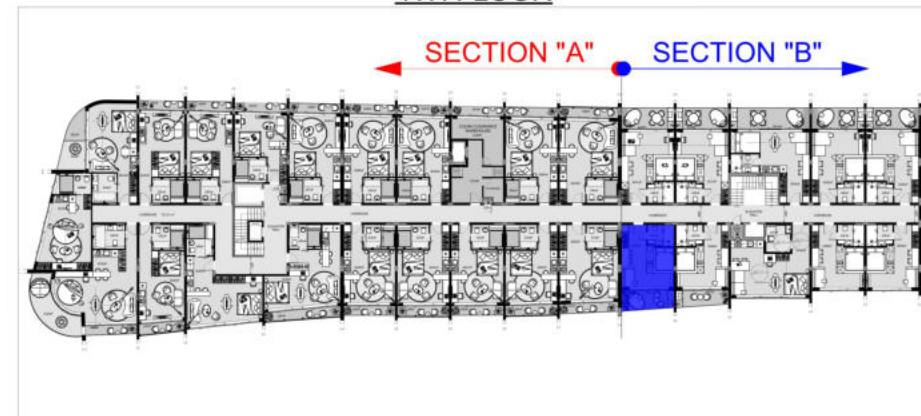

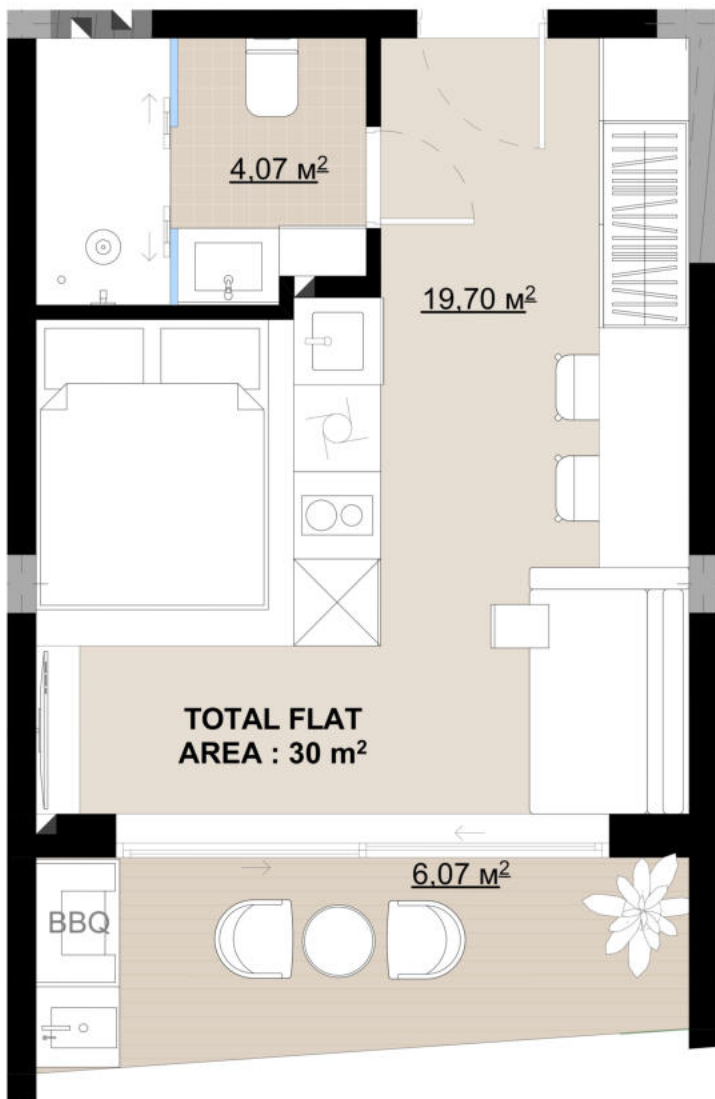

## SECTION "B"

UNIT 100

FLAT AREA : 23,5 m<sup>2</sup>

TERRACE AREA : 6,07 m<sup>2</sup>

TOTAL FLAT AREA : 30 m<sup>2</sup>



4TH FLOOR

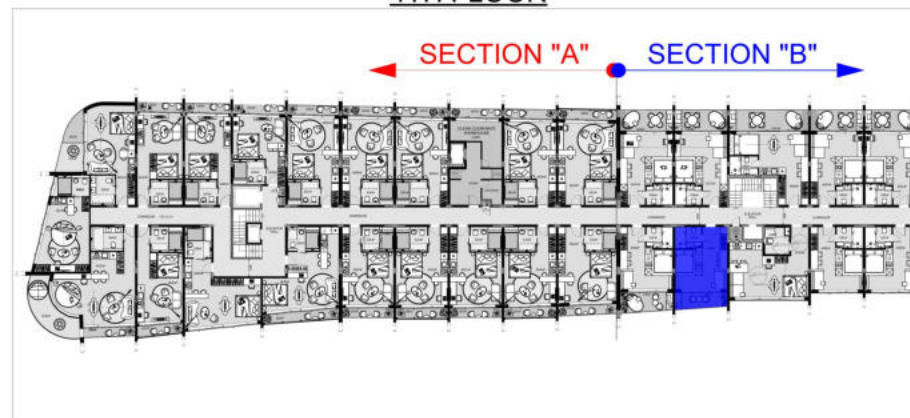



### SECTION "B"

UNIT 99

FLAT AREA : 36,5 m<sup>2</sup>

TERRACE AREA : 0 m<sup>2</sup>

TOTAL FLAT AREA : 36,5 m<sup>2</sup>

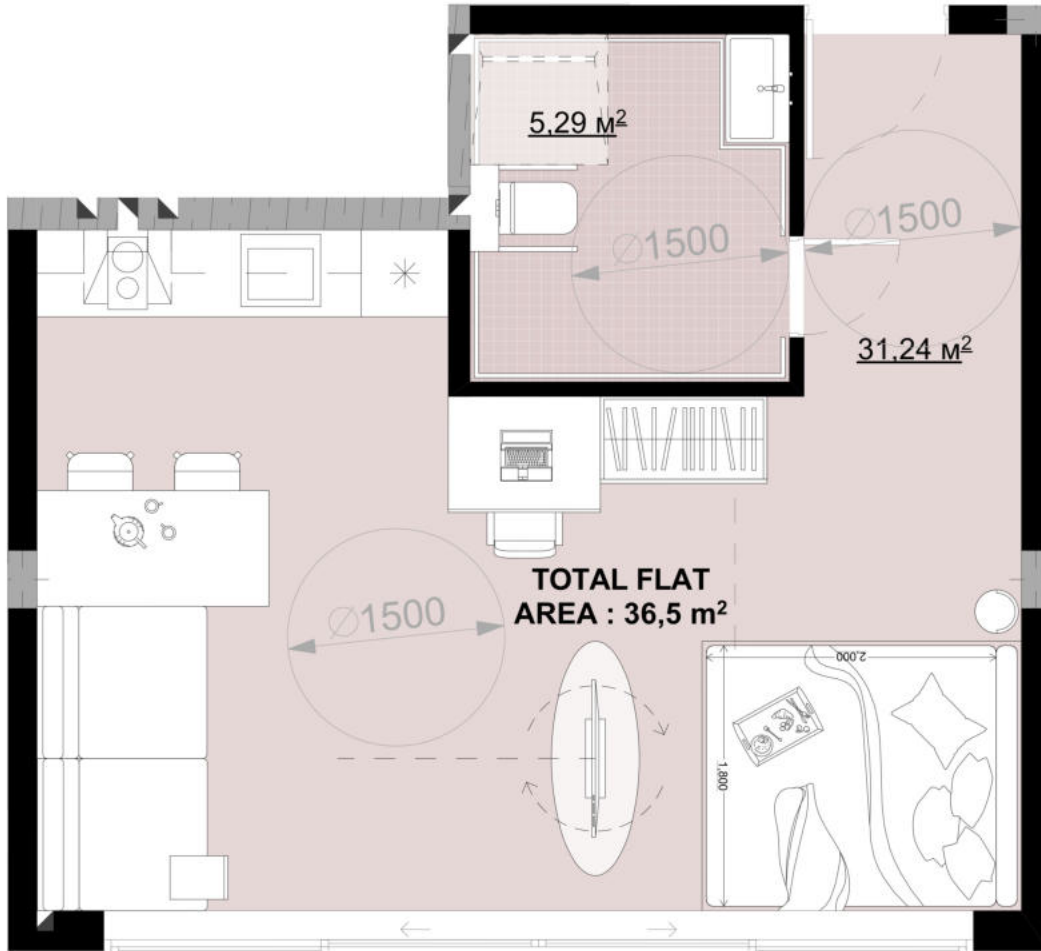

4TH FLOOR

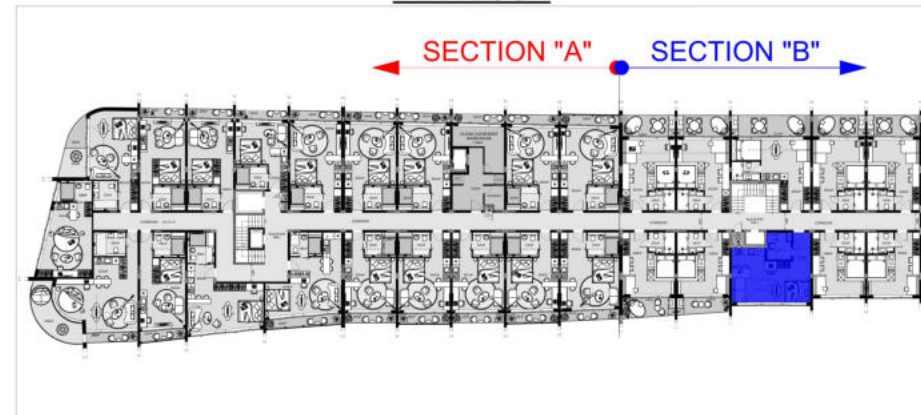

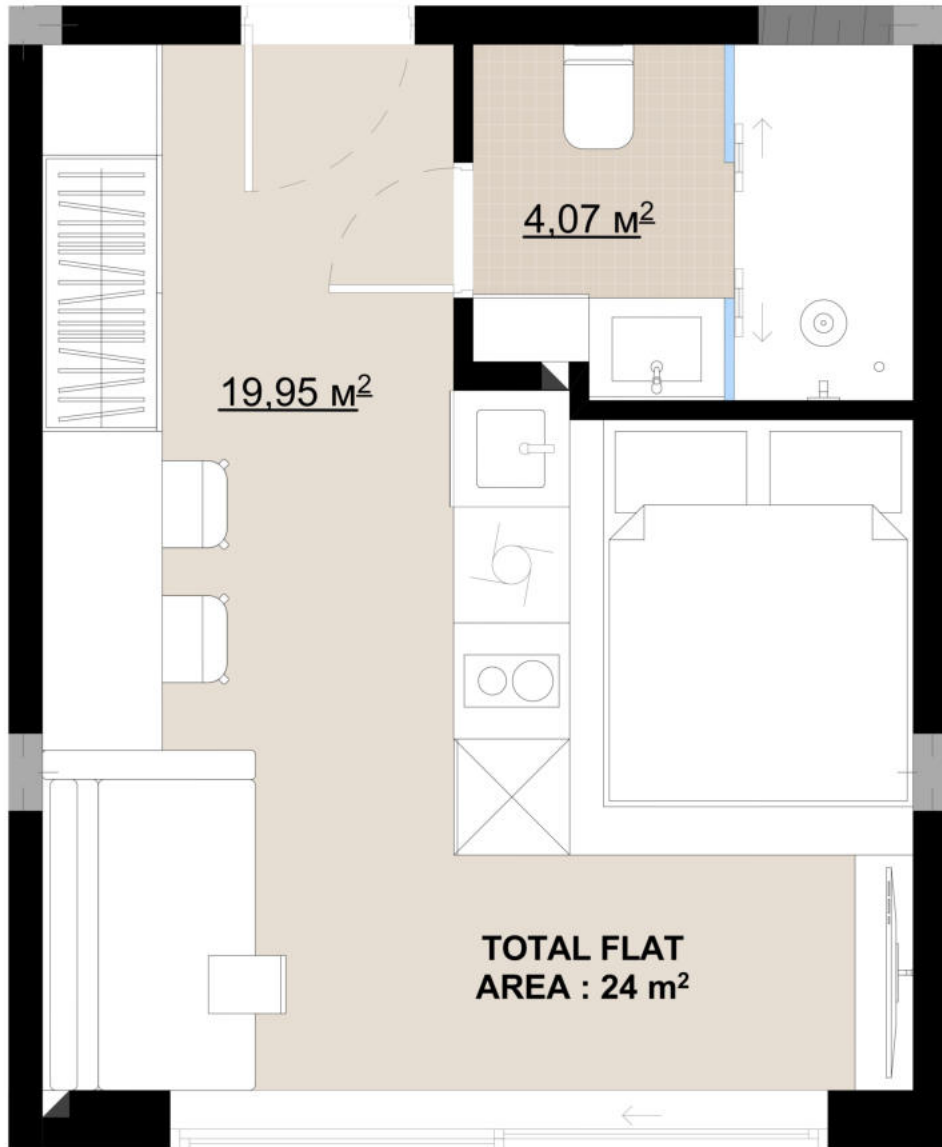

## SECTION "B"

UNIT 98

FLAT AREA : 24 m<sup>2</sup>

TERRACE AREA : 0 m<sup>2</sup>

TOTAL FLAT AREA : 24 m<sup>2</sup>



4TH FLOOR

SECTION "A" SECTION "B"

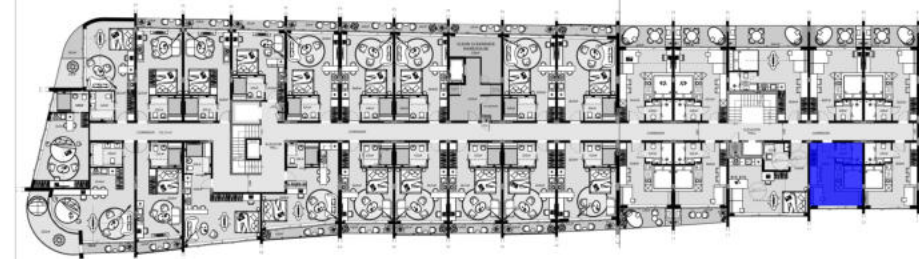

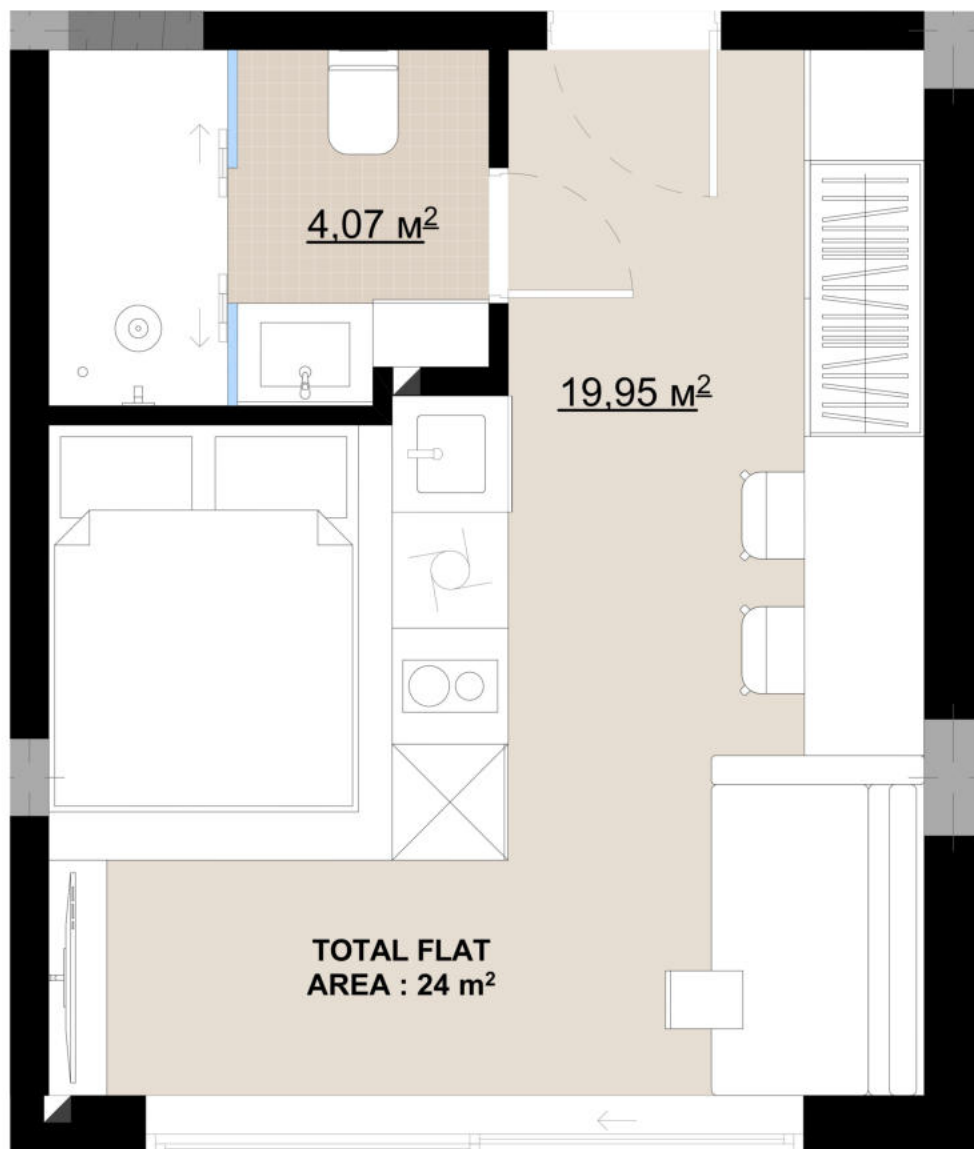

## SECTION "B"

UNIT 97

FLAT AREA : 24 m<sup>2</sup>

TERRACE AREA : 0 m<sup>2</sup>

TOTAL FLAT AREA : 24 m<sup>2</sup>



4TH FLOOR

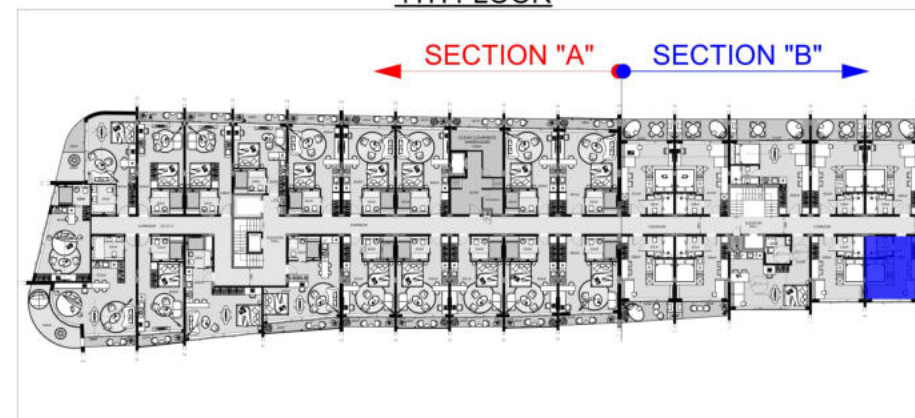



### SECTION "B"

UNIT 96

FLAT AREA : 26,96 m<sup>2</sup>

TERRACE AREA : 8,19 m<sup>2</sup>

TOTAL FLAT AREA : 35 m<sup>2</sup>

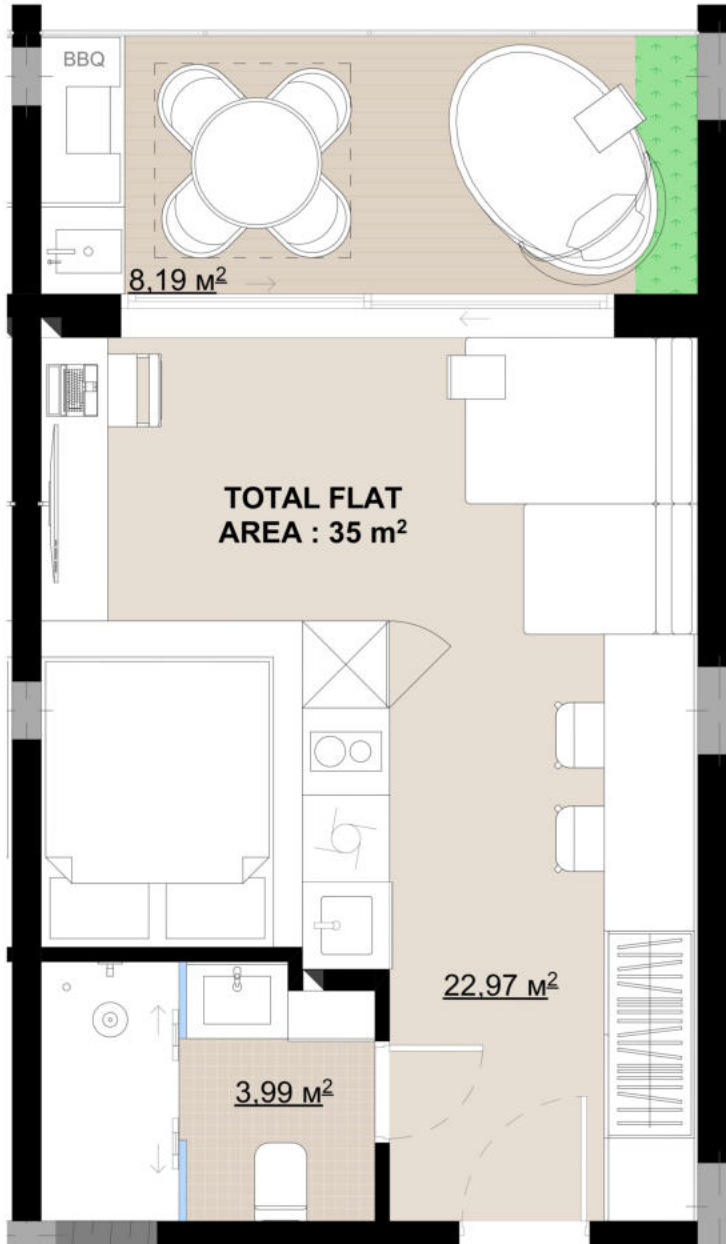

4TH FLOOR

SECTION "A" SECTION "B"

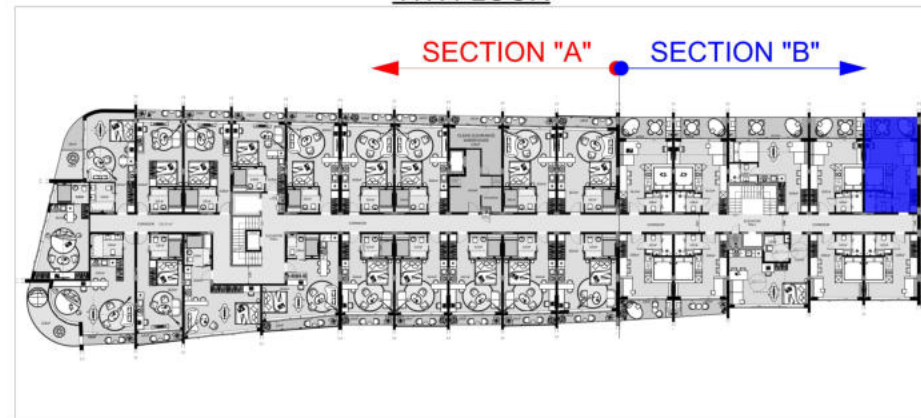

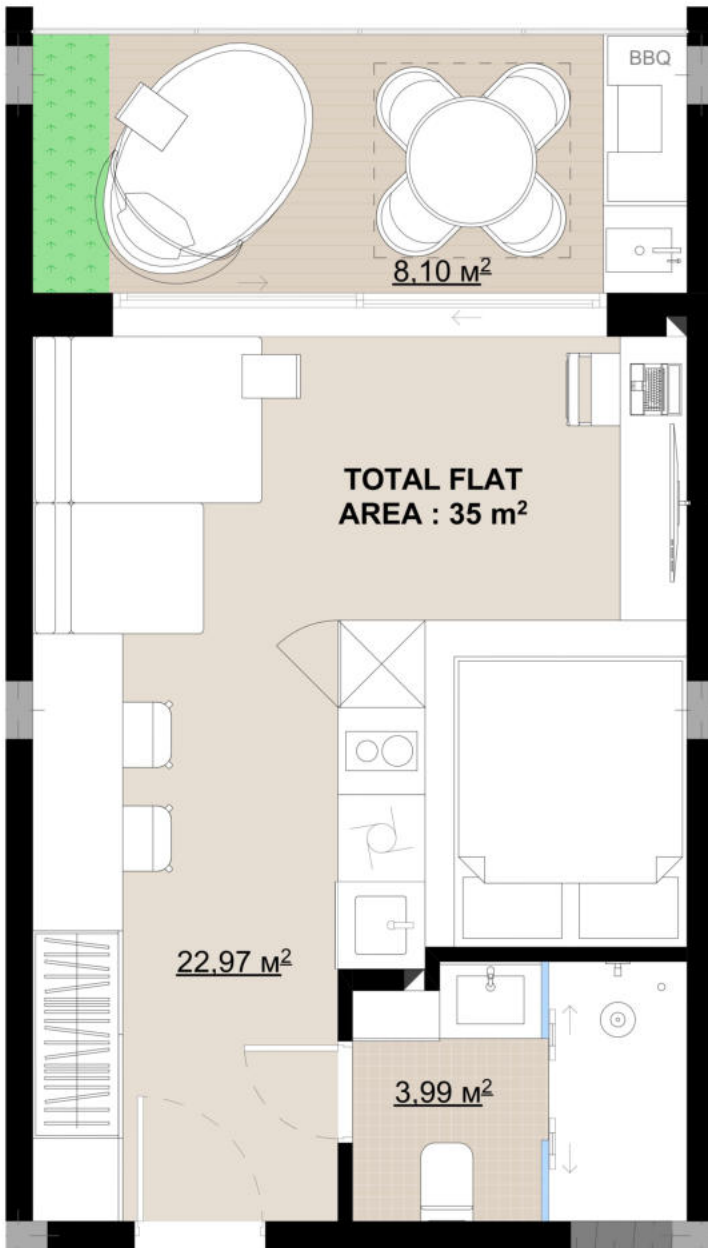

## SECTION "B"

UNIT 95

FLAT AREA : 26,96 m<sup>2</sup>

TERRACE AREA : 8,10 m<sup>2</sup>

TOTAL FLAT AREA : 35 m<sup>2</sup>



4TH FLOOR

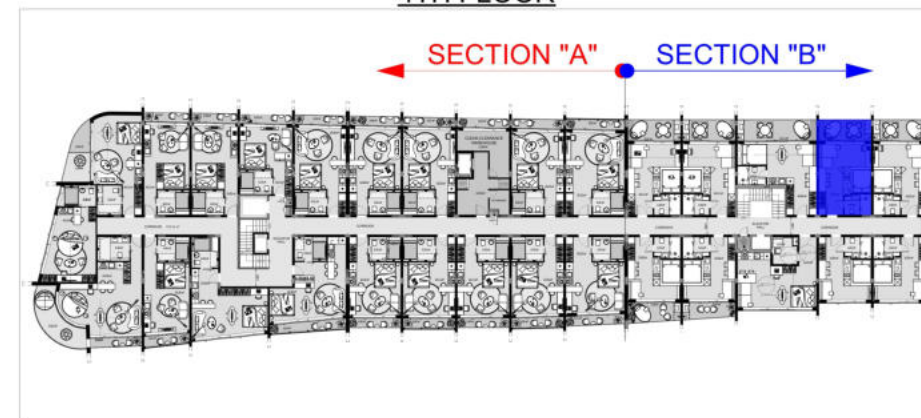



### SECTION "B"

UNIT 94

FLAT AREA : 29,97 m<sup>2</sup>

TERRACE AREA : 12,31 m<sup>2</sup>

TOTAL FLAT AREA : 43 m<sup>2</sup>

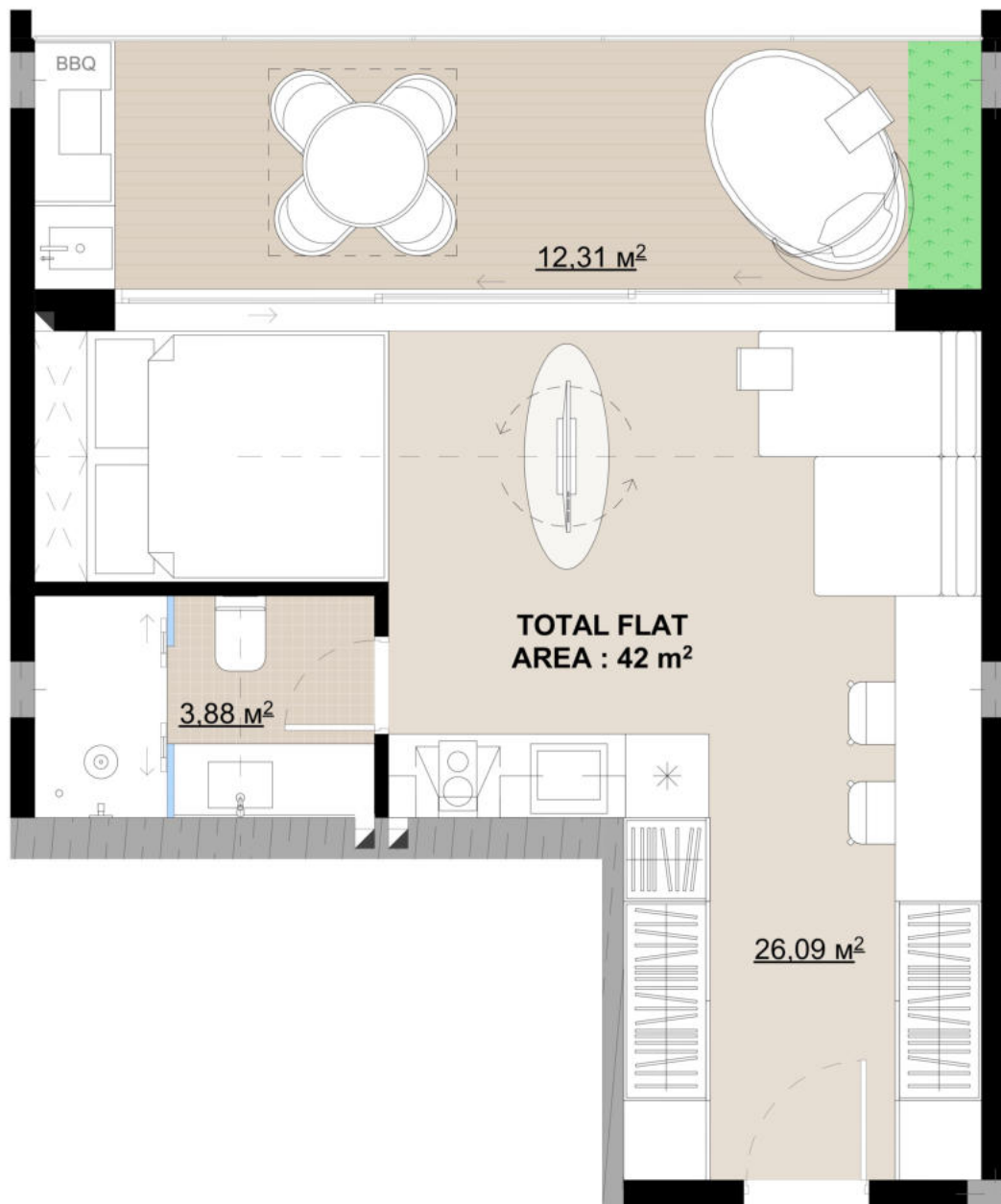

4TH FLOOR

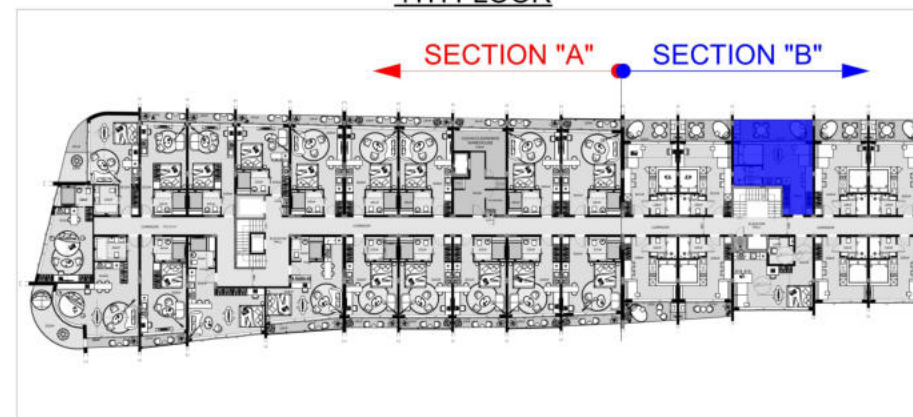

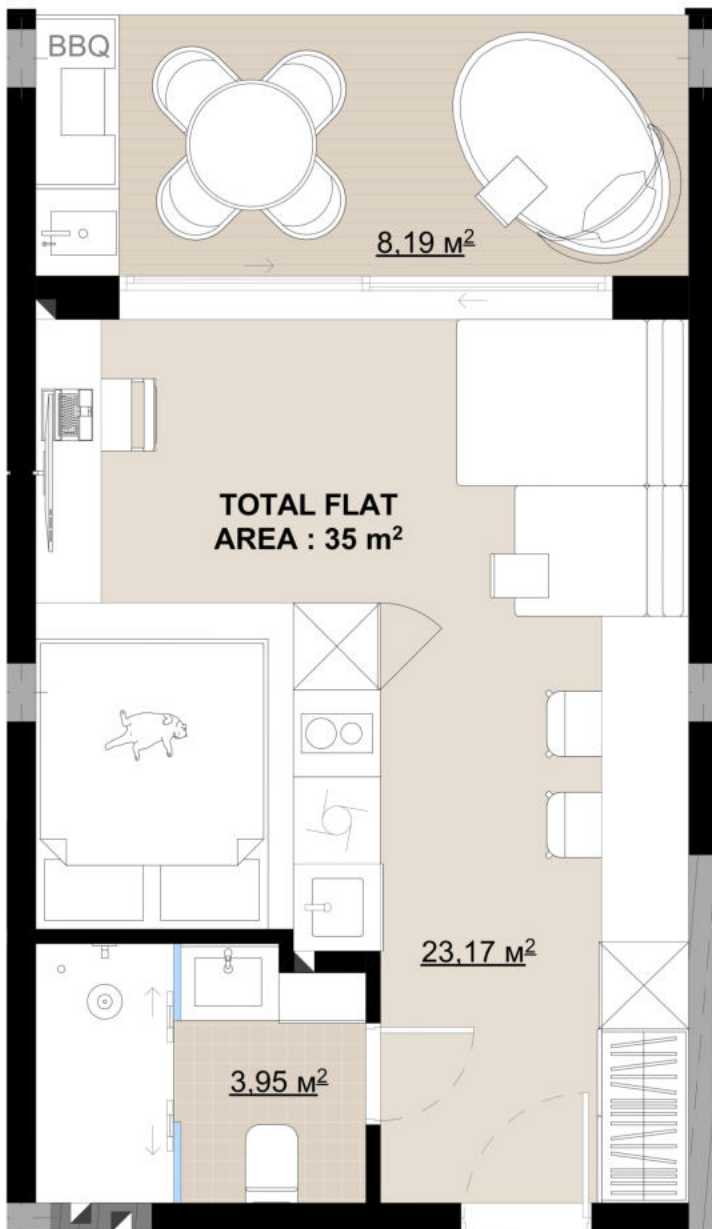

## SECTION "B"

UNIT 93

FLAT AREA : 27,12 m<sup>2</sup>

TERRACE AREA : 8,19 m<sup>2</sup>

TOTAL FLAT AREA : 35 m<sup>2</sup>



4TH FLOOR

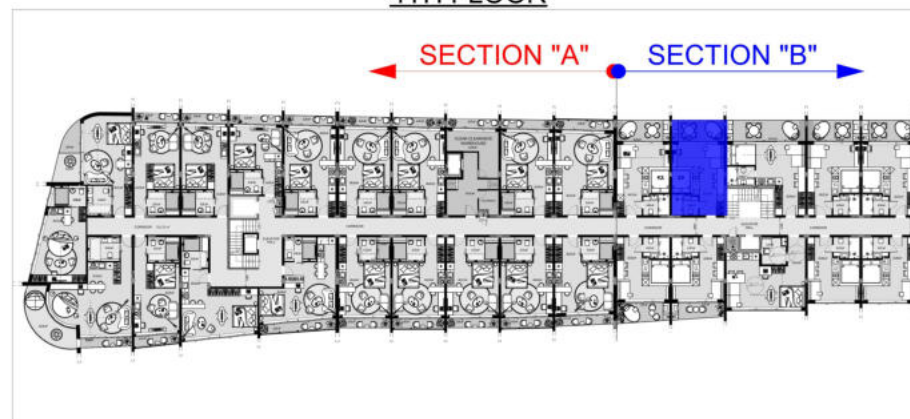



## SECTION "B"

UNIT 92

FLAT AREA : 27,12 m<sup>2</sup>

TERRACE AREA : 8,19 m<sup>2</sup>

TOTAL FLAT AREA : 35 m<sup>2</sup>

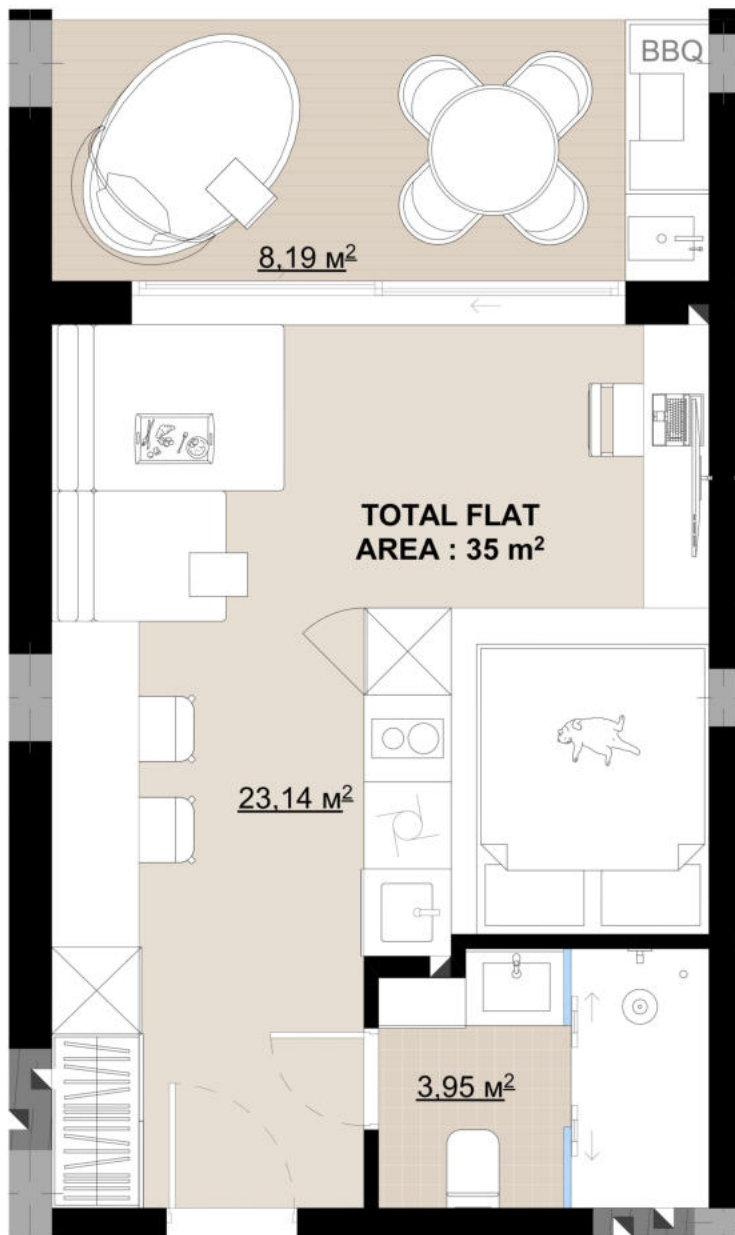

4TH FLOOR

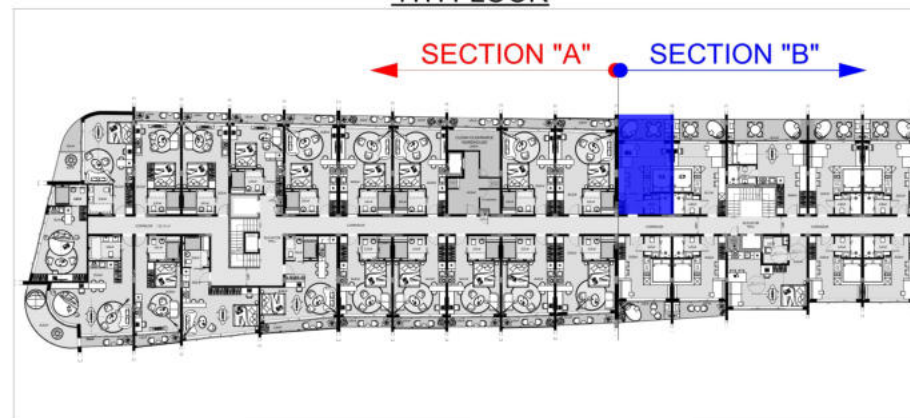

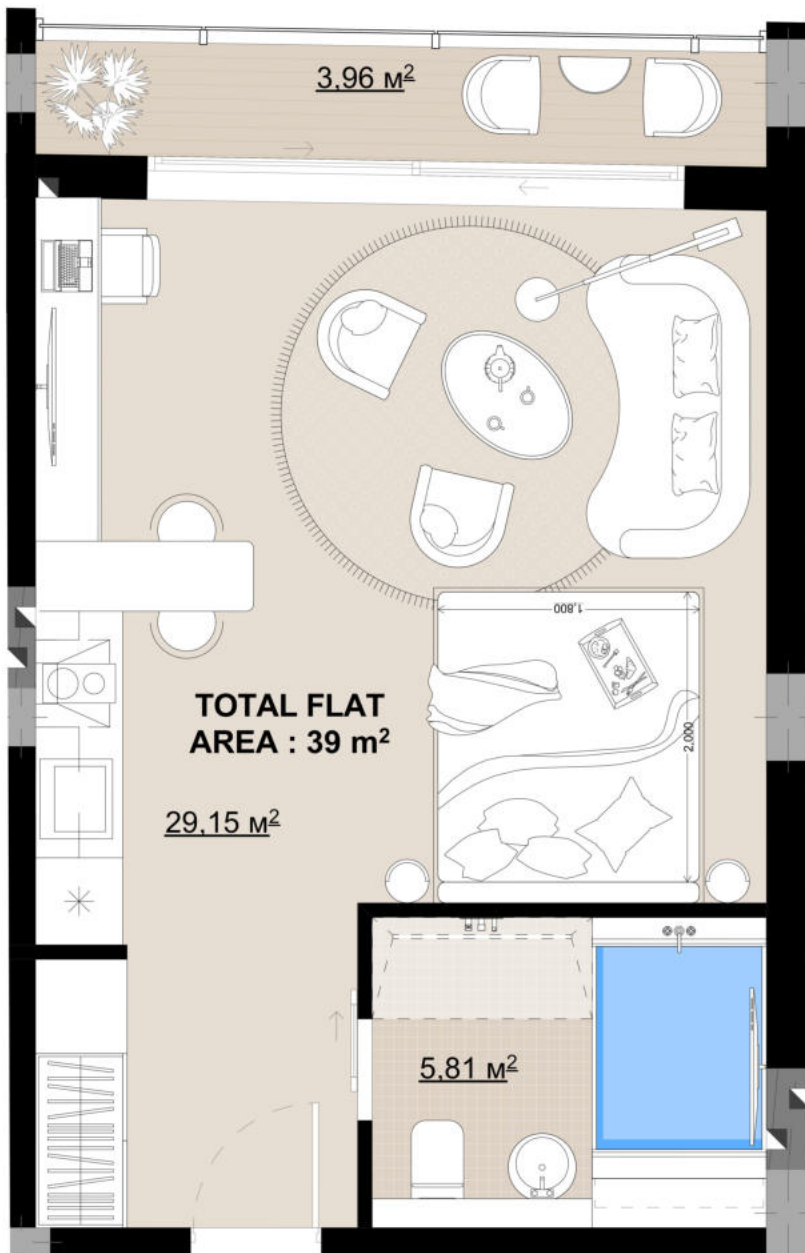

### SECTION "A"

UNIT 91

FLAT AREA : 34,96 m<sup>2</sup>

TERRACE AREA : 3.96 m<sup>2</sup>

TOTAL FLAT AREA : 39 m<sup>2</sup>



4TH FLOOR

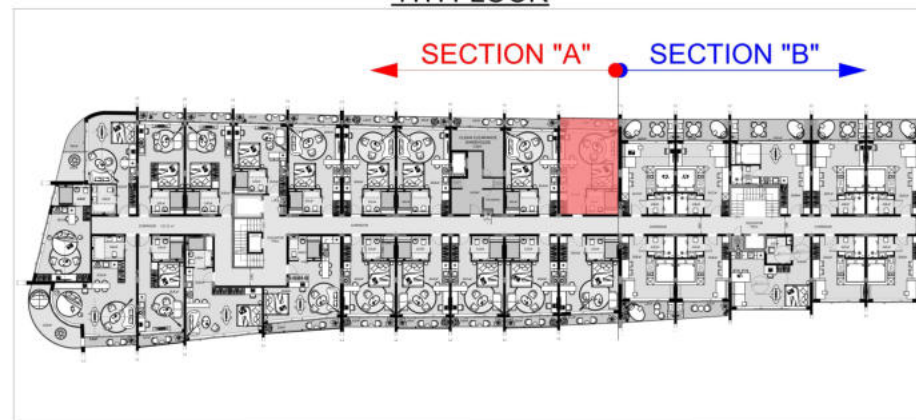

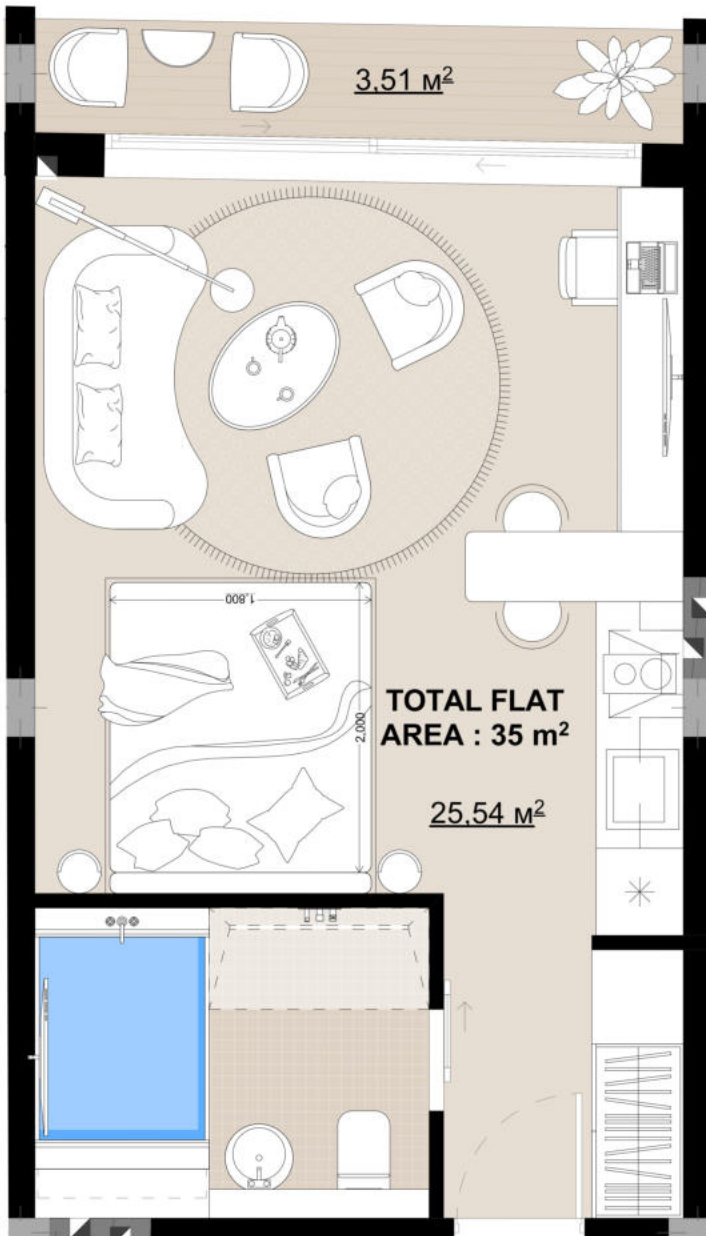

## SECTION "A"

UNIT 90

FLAT AREA : 31.35 m<sup>2</sup>

TERRACE AREA : 3.51 m<sup>2</sup>

TOTAL FLAT AREA : 35 m<sup>2</sup>



4TH FLOOR

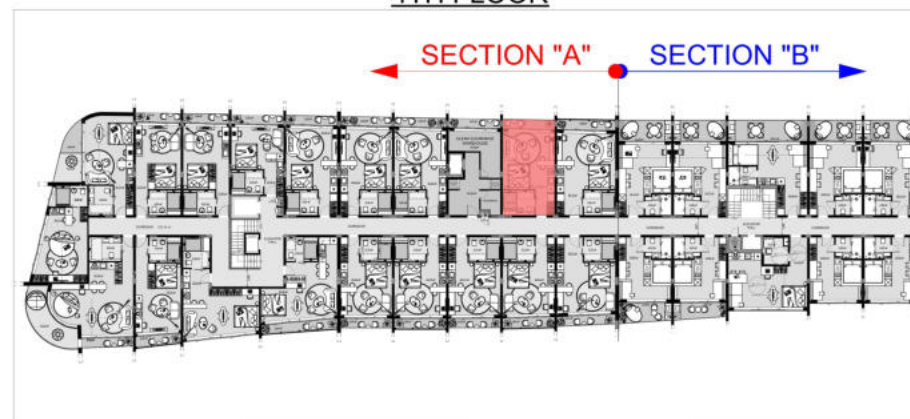

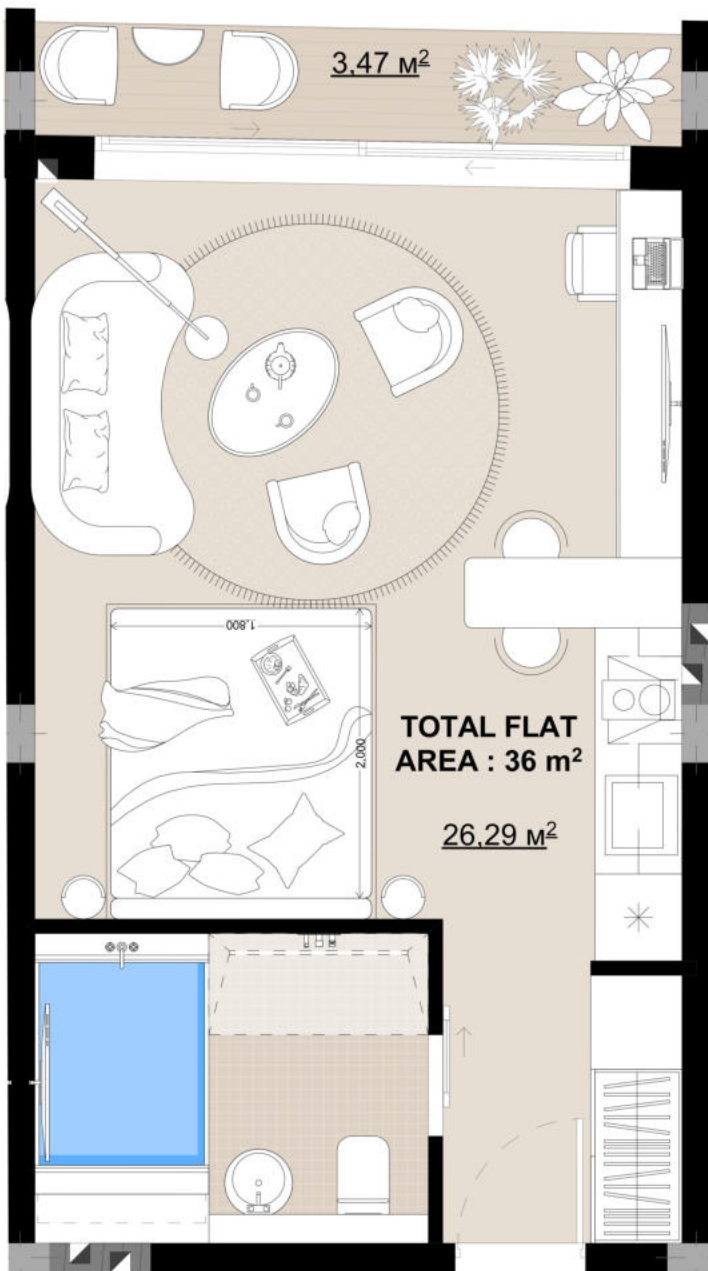

## SECTION "A"

UNIT 89

FLAT AREA : 32,1 m<sup>2</sup>

TERRACE AREA : 3,47 m<sup>2</sup>

TOTAL FLAT AREA : 36 m<sup>2</sup>



4TH FLOOR

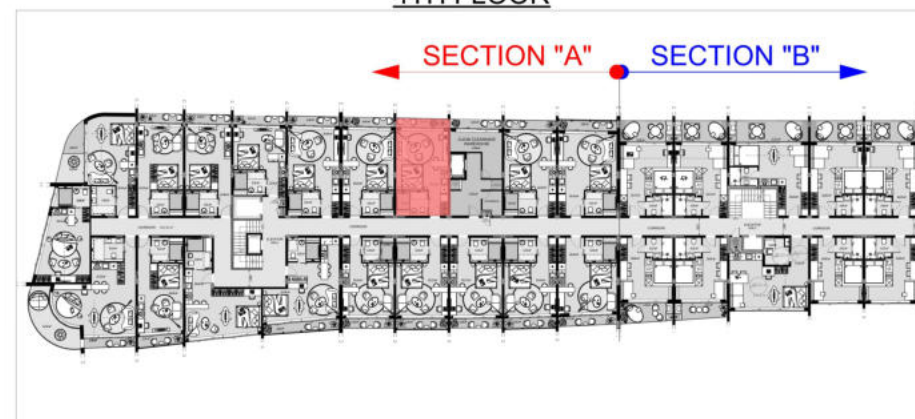

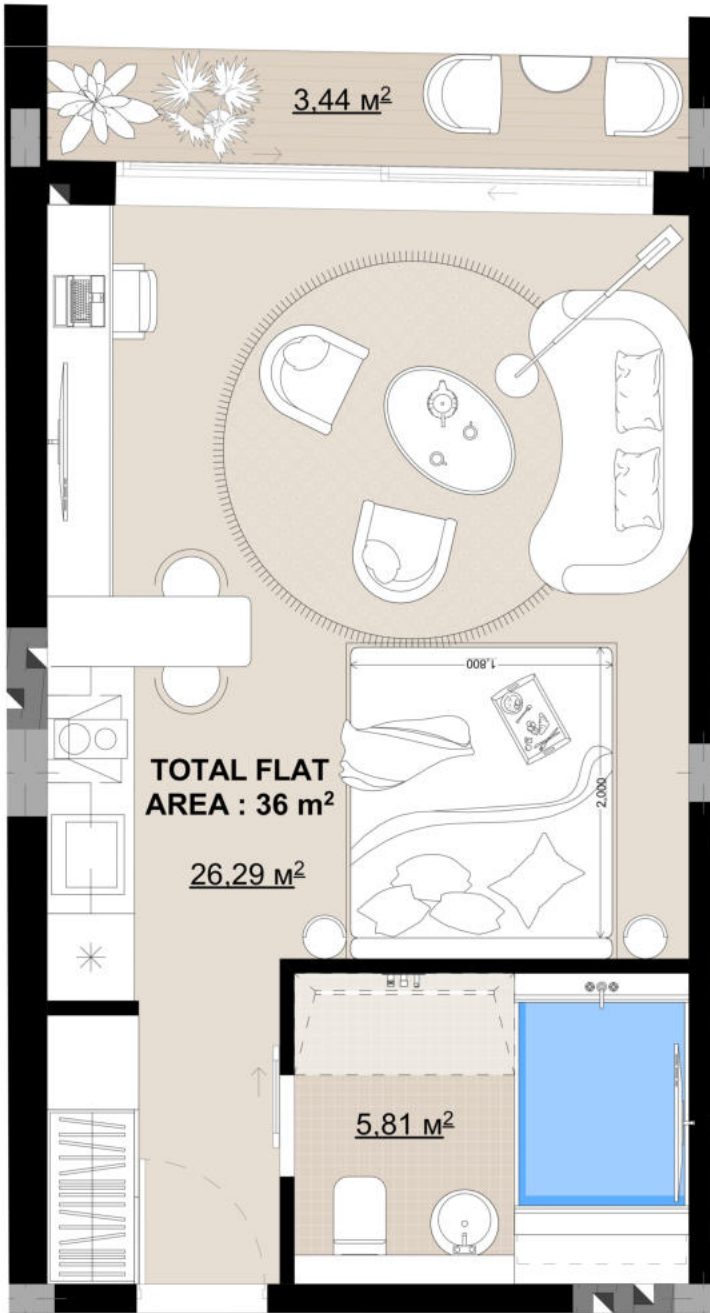

## SECTION "A"

UNIT 88

FLAT AREA : 32,1 m<sup>2</sup>

TERRACE AREA : 3,44 m<sup>2</sup>

TOTAL FLAT AREA : 36 m<sup>2</sup>



4TH FLOOR

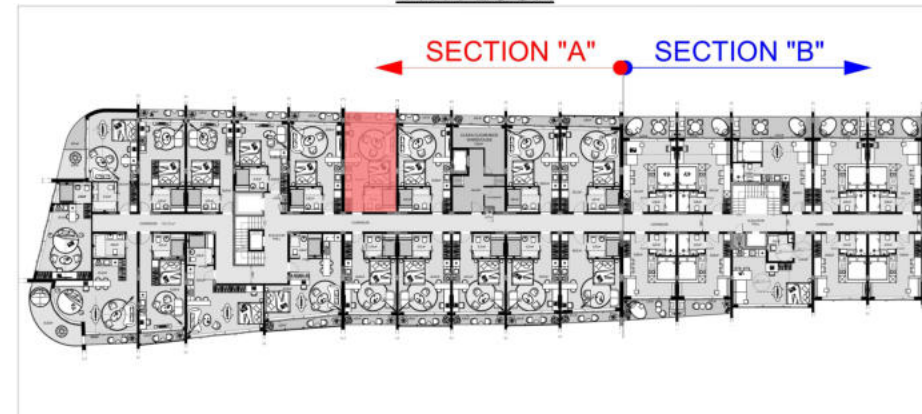

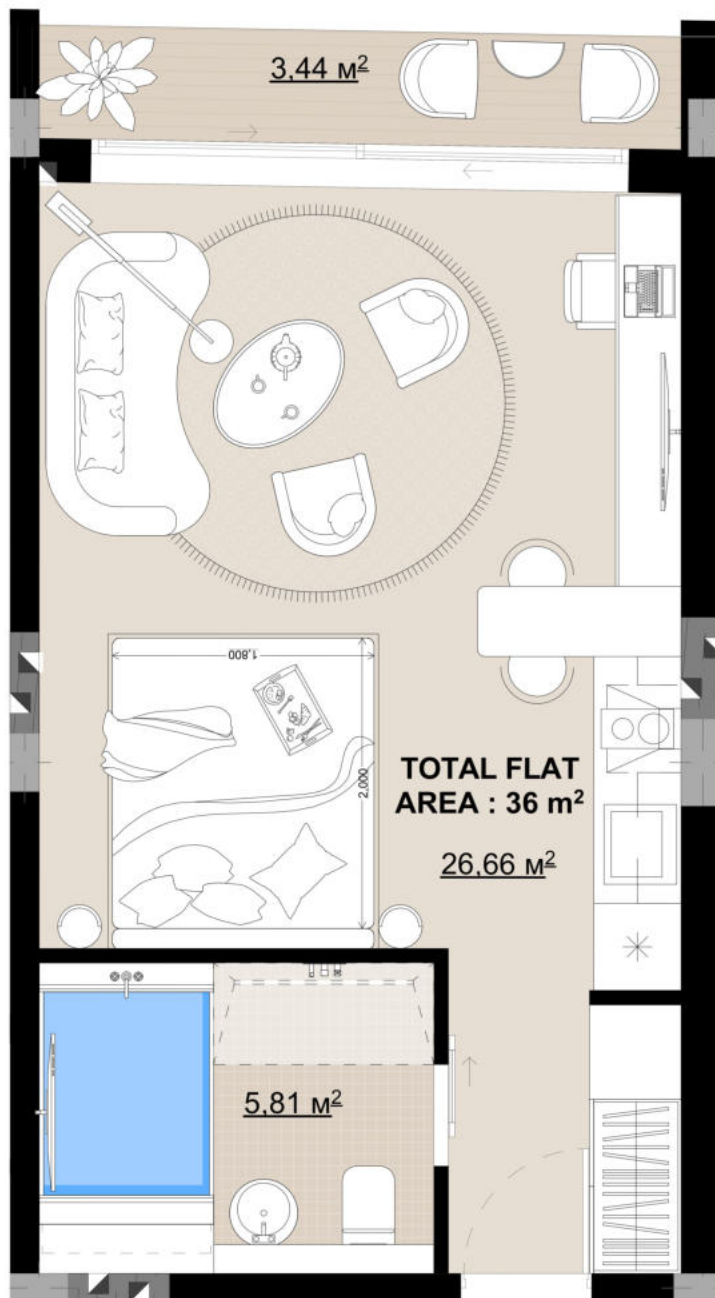

## SECTION "A"

UNIT 87

FLAT AREA : 32,47 m<sup>2</sup>

TERRACE AREA : 3,44 m<sup>2</sup>

TOTAL FLAT AREA : 36 m<sup>2</sup>



4TH FLOOR

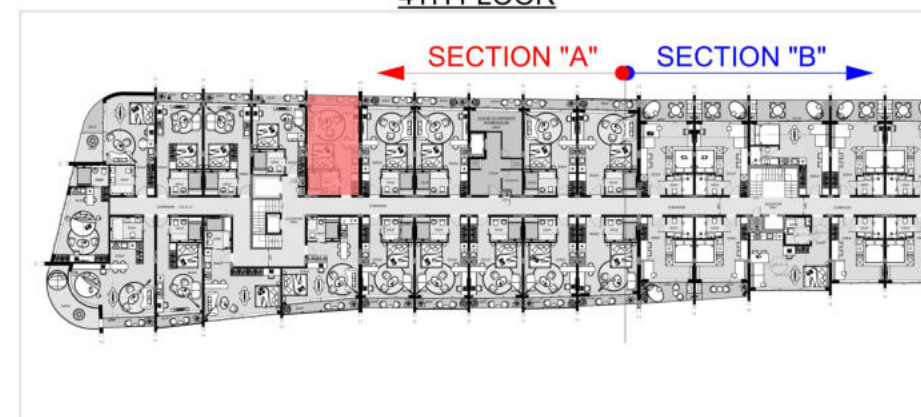

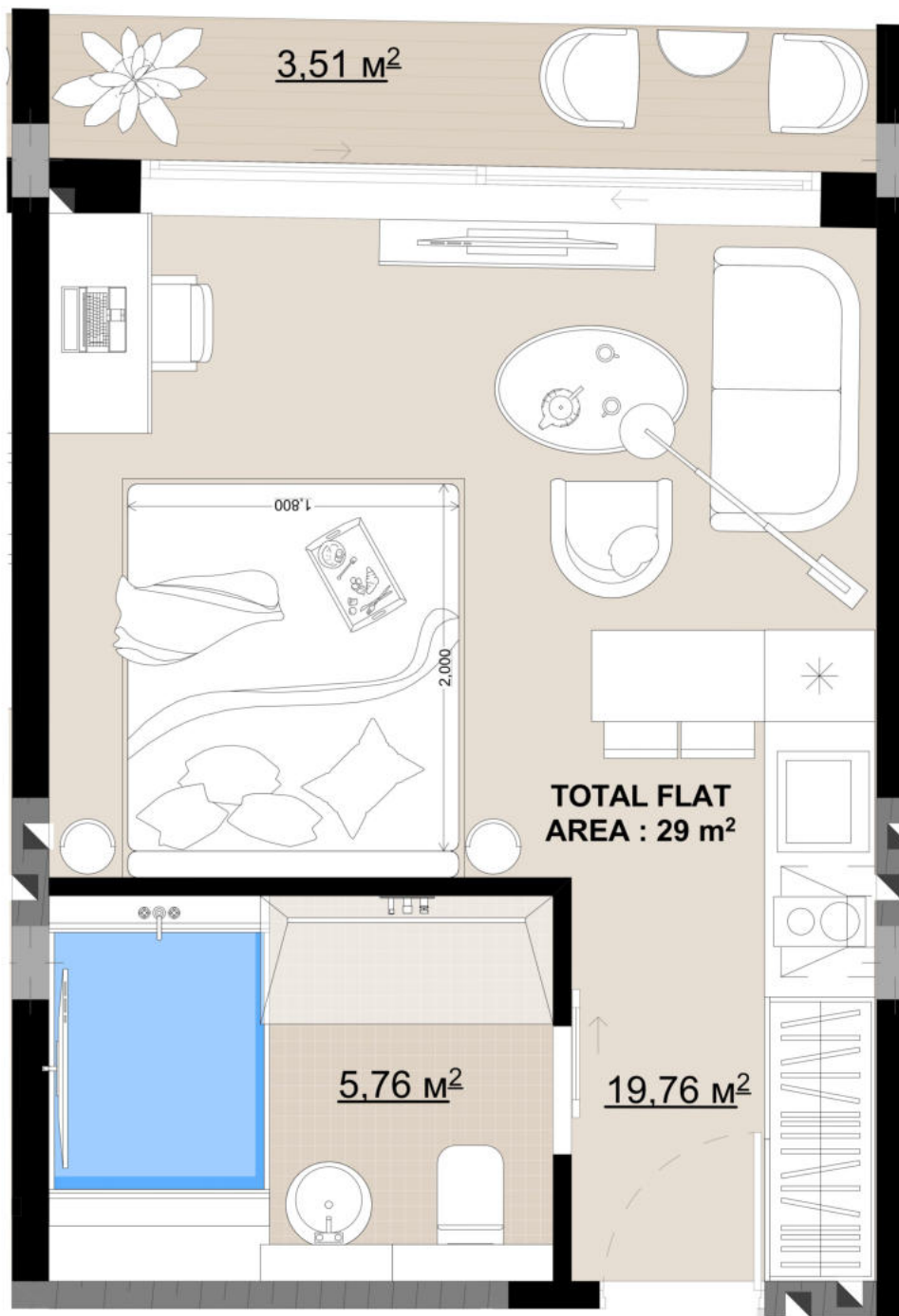

### SECTION "A"

UNIT 86

FLAT AREA : 25.52 m<sup>2</sup>

TERRACE AREA : 3.51 m<sup>2</sup>

TOTAL FLAT AREA : 29 m<sup>2</sup>



4TH FLOOR

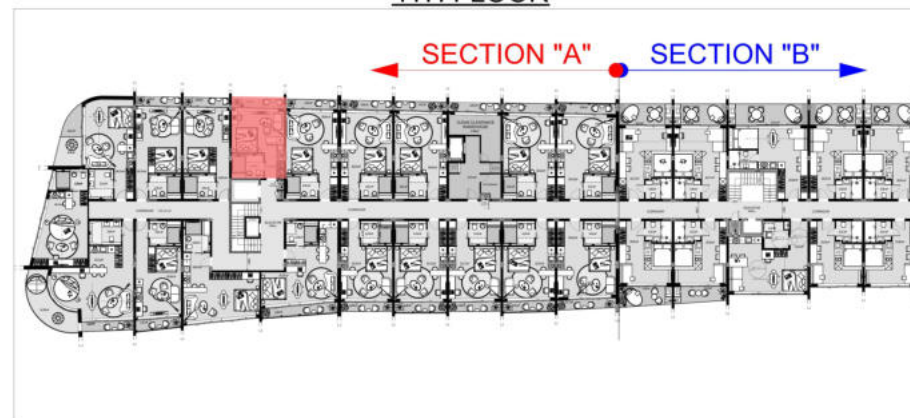

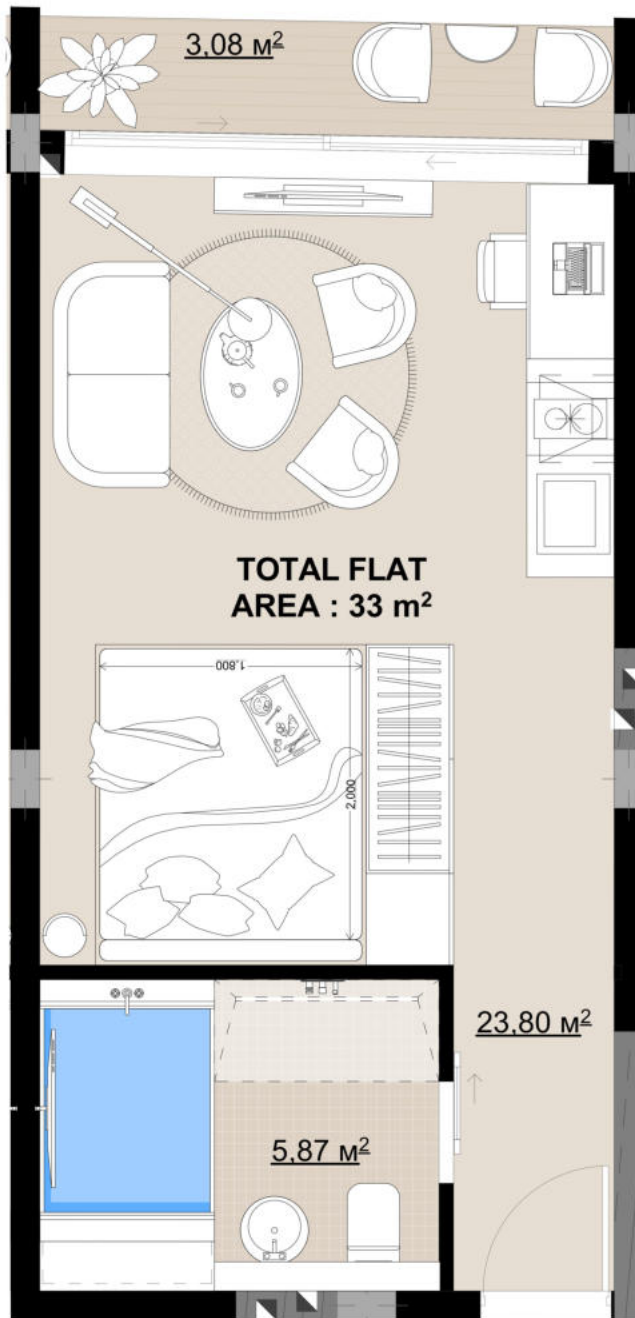

### SECTION "A"

UNIT 85

FLAT AREA : 29,67 m<sup>2</sup>

TERRACE AREA : 3,08 m<sup>2</sup>

TOTAL FLAT AREA : 33 m<sup>2</sup>



4TH FLOOR

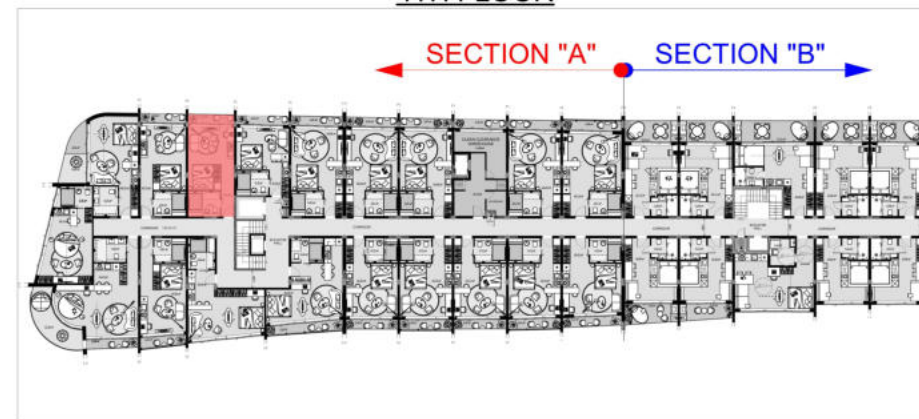

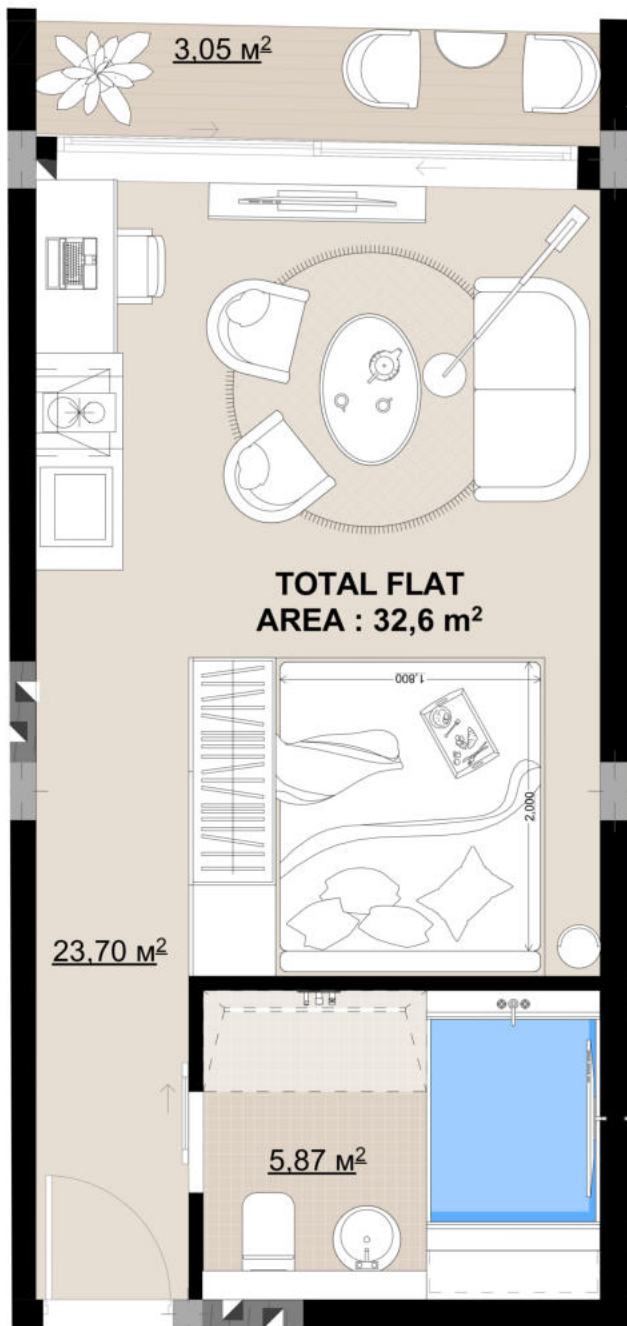

### SECTION "A"

UNIT 84

FLAT AREA : 29,57 m<sup>2</sup>

TERRACE AREA : 3.05 m<sup>2</sup>

**TOTAL FLAT AREA : 32.6 m<sup>2</sup>**



4TH FLOOR

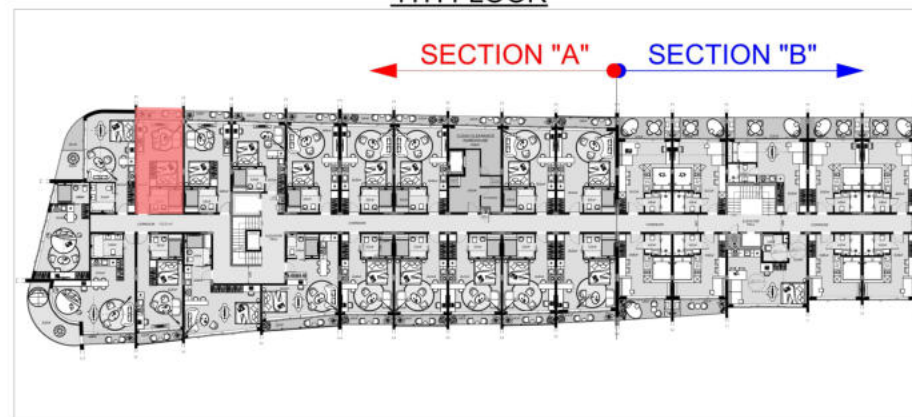

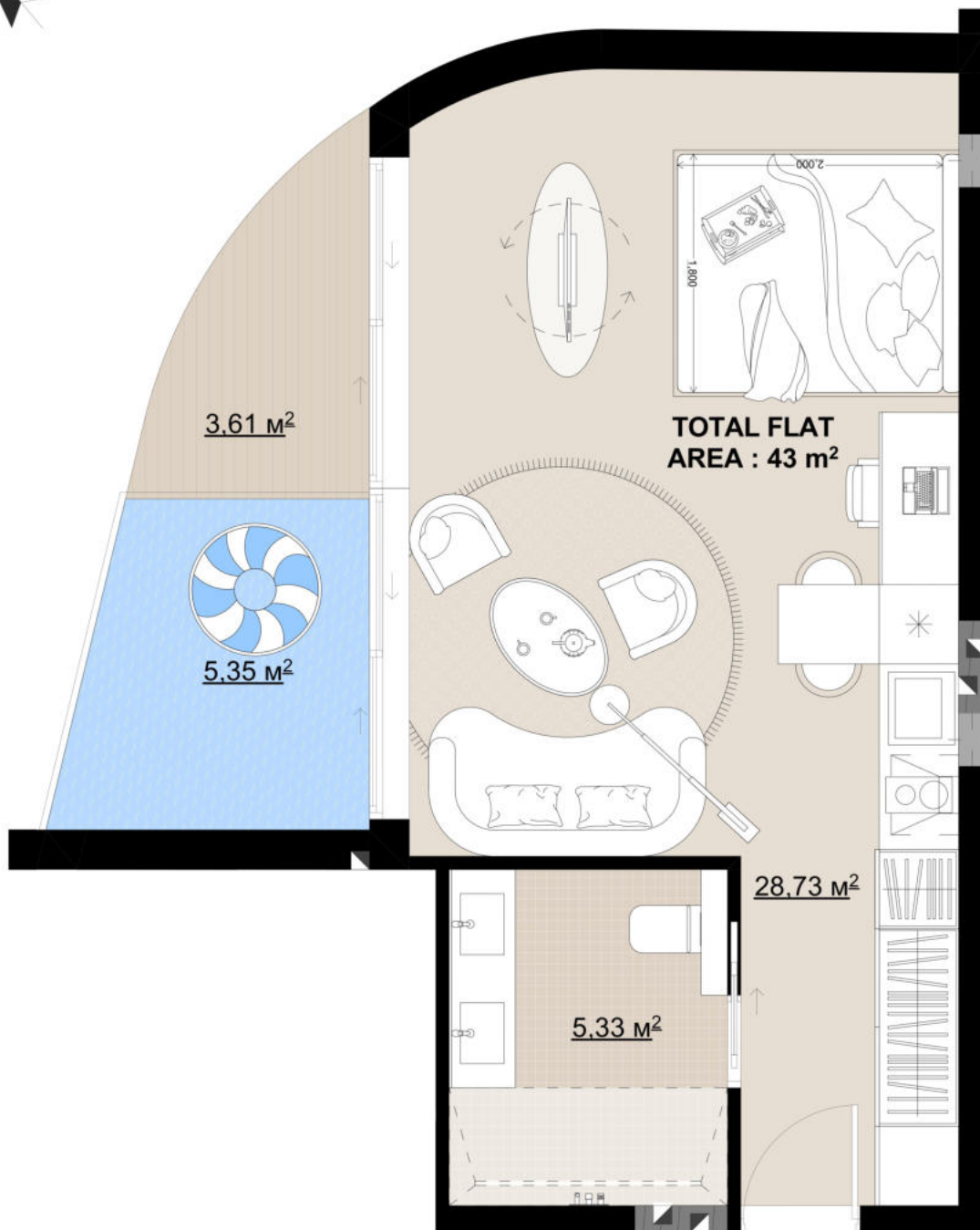

## SECTION "A"

UNIT 83

FLAT AREA : 34 m<sup>2</sup>

TERRACE AREA : 8,96 m<sup>2</sup>

TOTAL FLAT AREA : 43 m<sup>2</sup>



4TH FLOOR

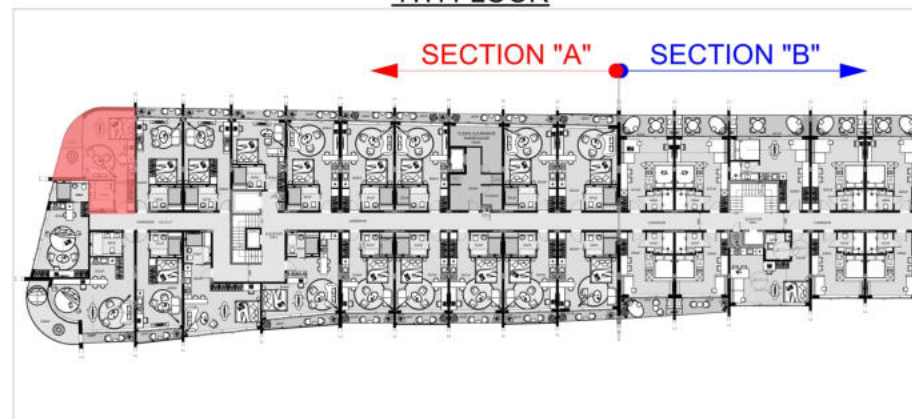

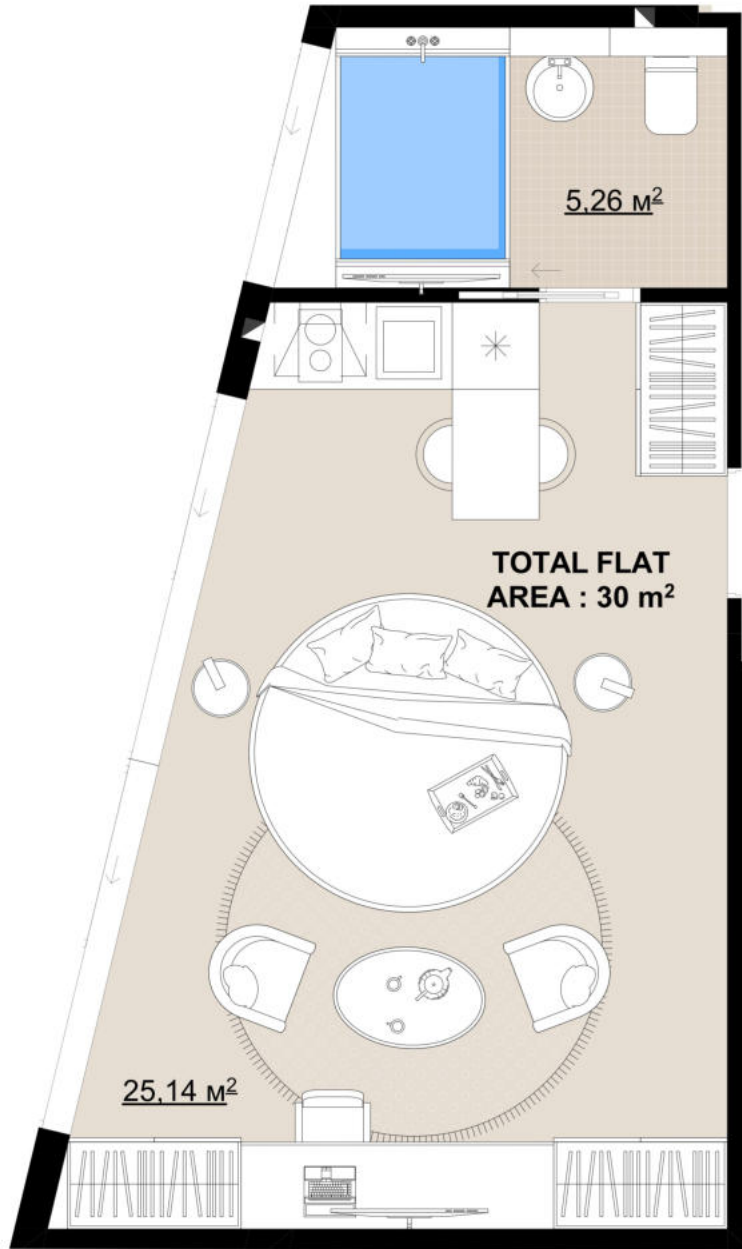

## SECTION "A"

UNIT 82

FLAT AREA : 30 m<sup>2</sup>

TERRACE AREA : 0 m<sup>2</sup>

TOTAL FLAT AREA : 30 m<sup>2</sup>



3RD FLOOR

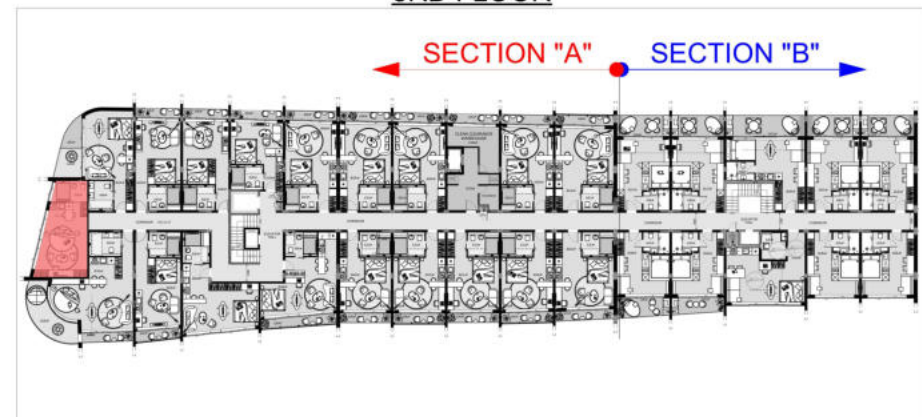

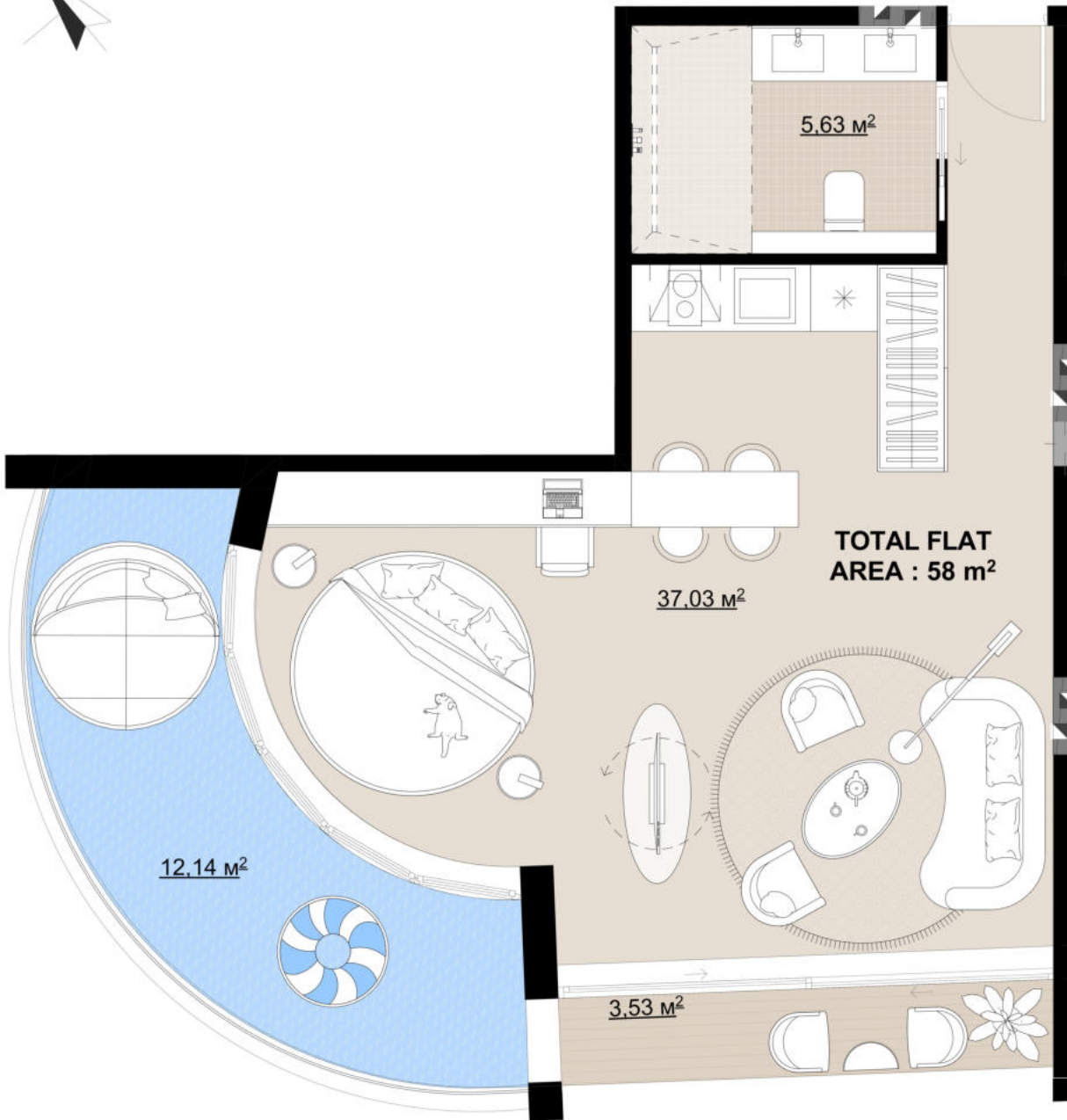

## SECTION "A"

UNIT 81

FLAT AREA : 42,66 m<sup>2</sup>

TERRACE AREA : 15,67 m<sup>2</sup>

TOTAL FLAT AREA : 58 m<sup>2</sup>



3RD FLOOR

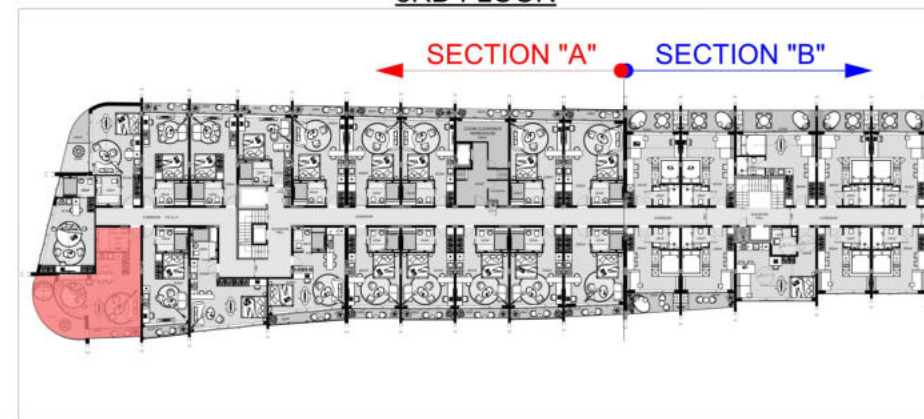

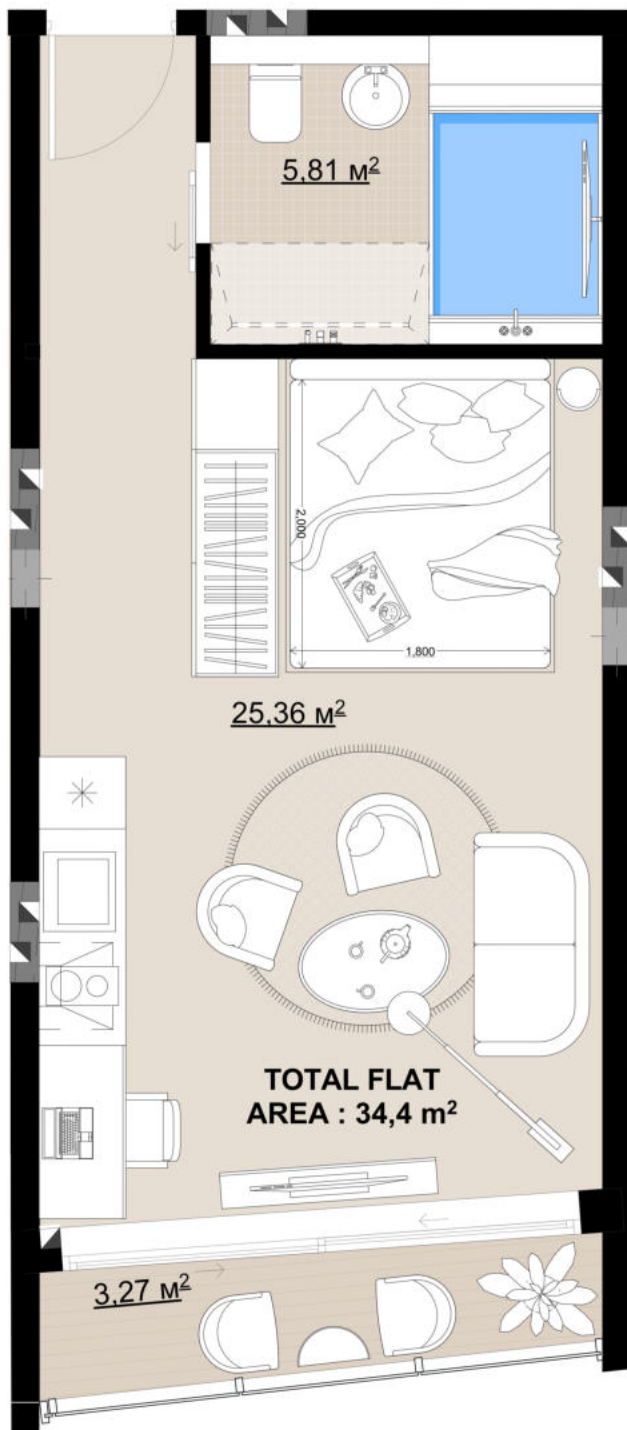

### SECTION "A"

UNIT 80

FLAT AREA : 31,17 m<sup>2</sup>

TERRACE AREA : 3.27 m<sup>2</sup>

TOTAL FLAT AREA : 34.4 m<sup>2</sup>



3RD FLOOR

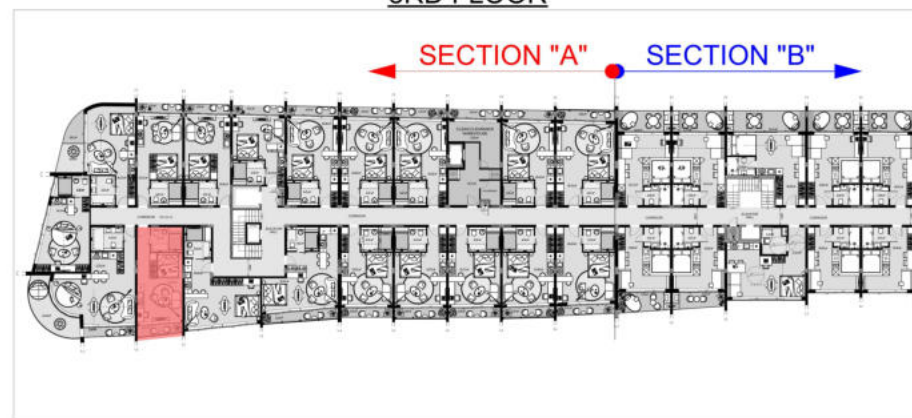

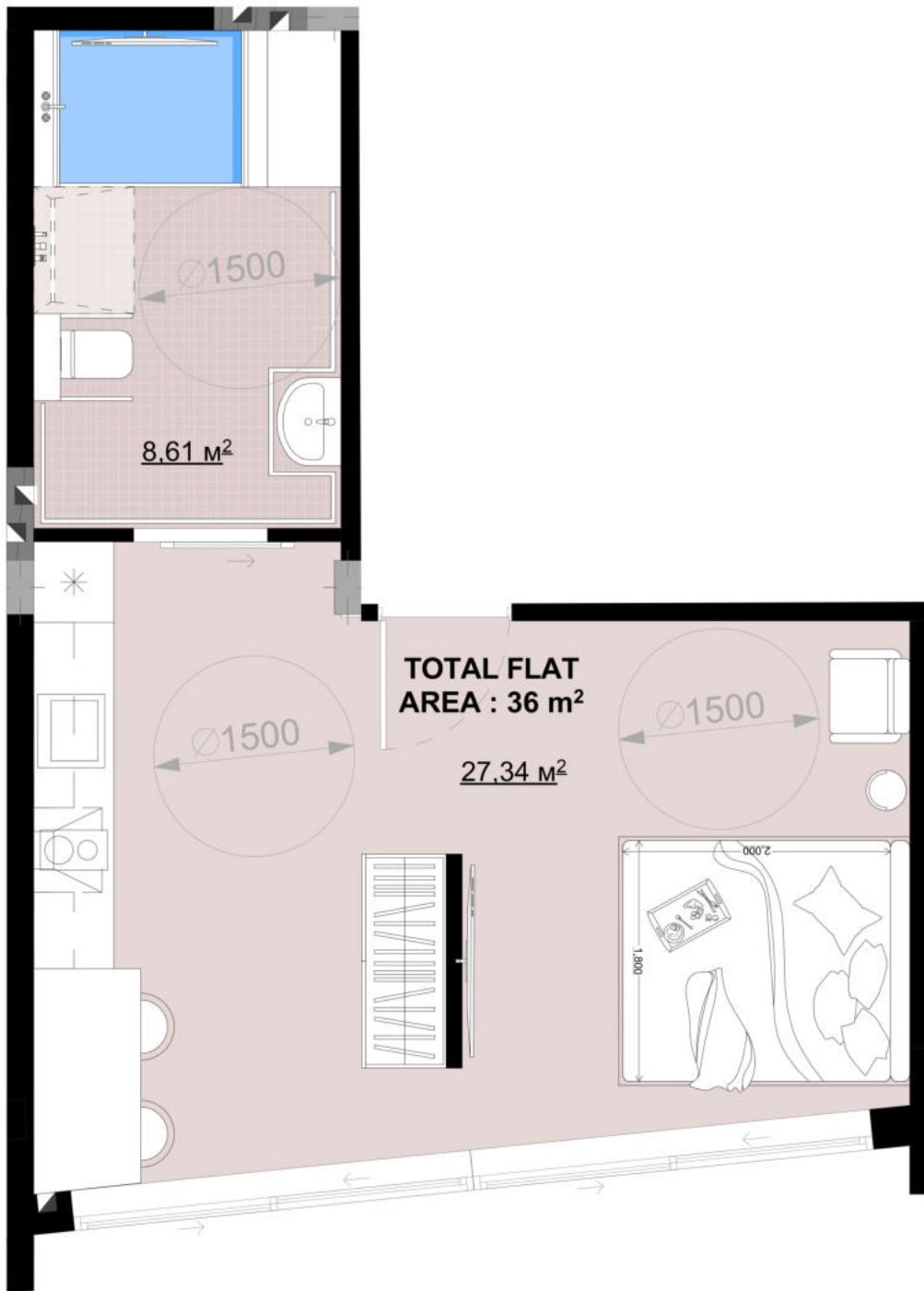

## SECTION "A"

UNIT 79

FLAT AREA : 36 m<sup>2</sup>

TERRACE AREA : 0 m<sup>2</sup>

TOTAL FLAT AREA : 36 m<sup>2</sup>



3RD FLOOR

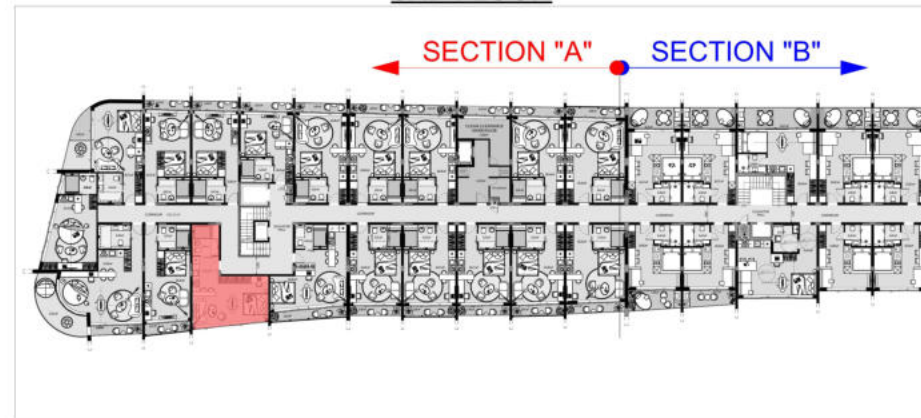

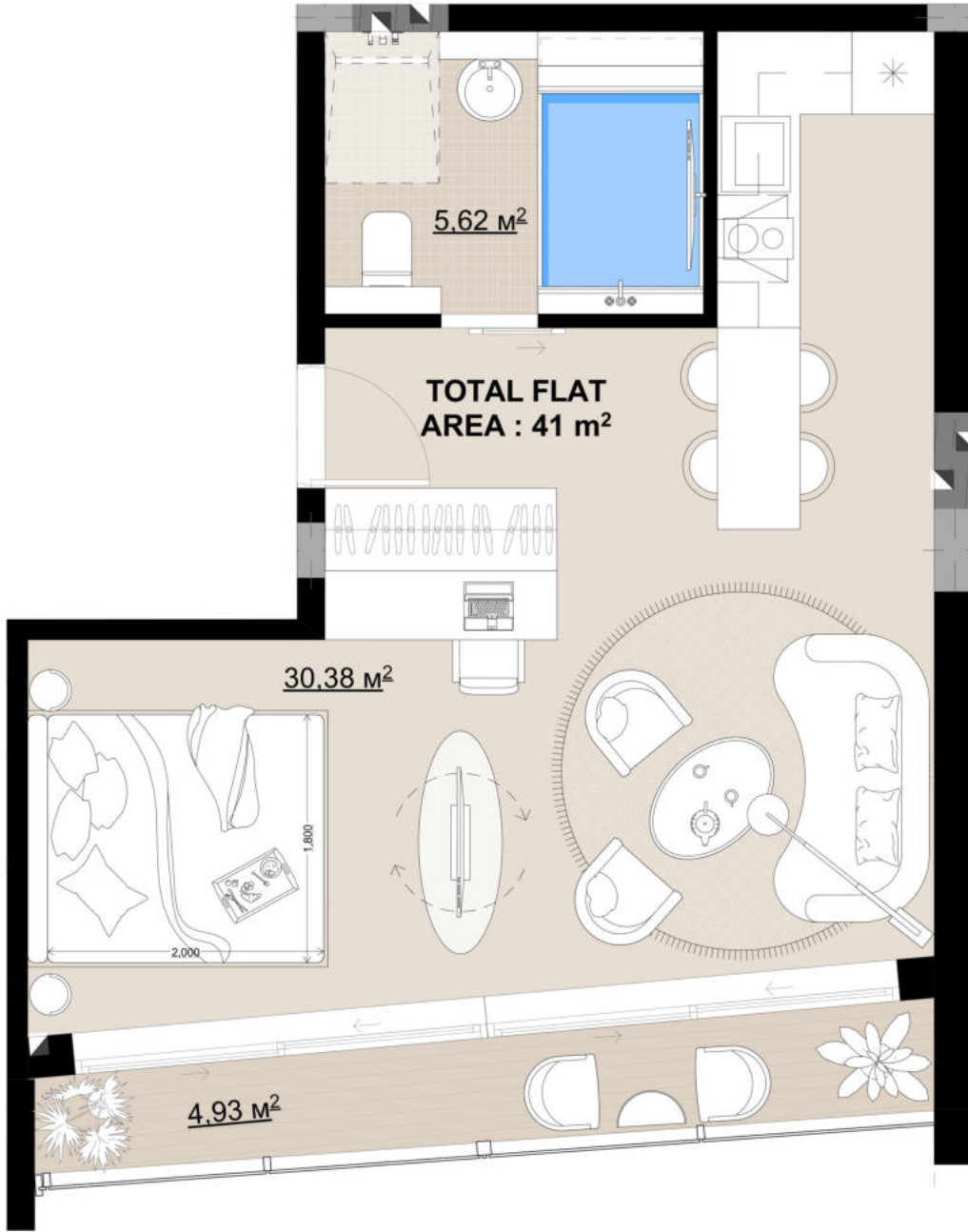

## SECTION "A"

UNIT 78

FLAT AREA : 36 m<sup>2</sup>

TERRACE AREA : 4,93 m<sup>2</sup>

TOTAL FLAT AREA : 41 m<sup>2</sup>



3RD FLOOR

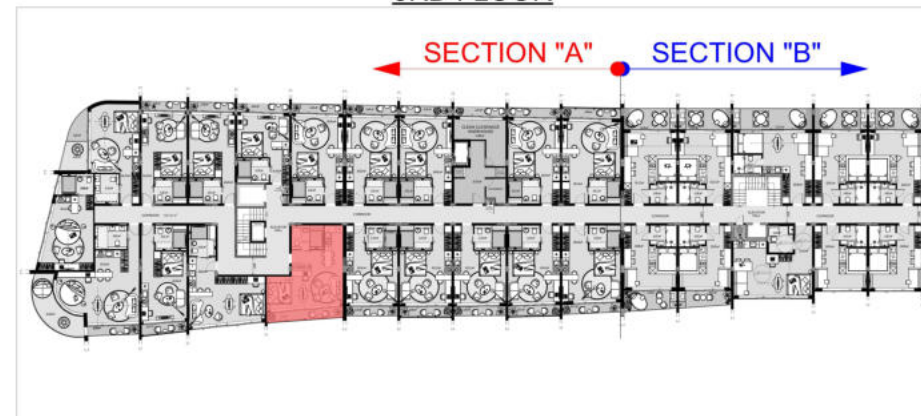

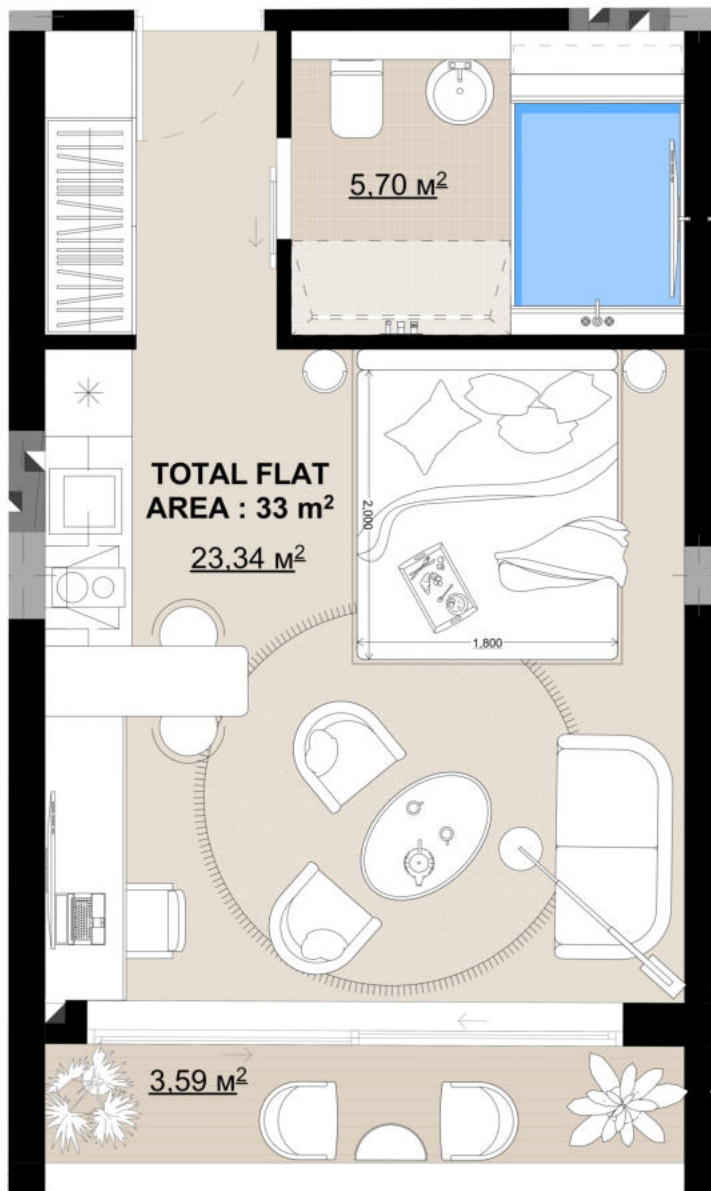

### SECTION "A"

UNIT 77

FLAT AREA : 29,04 m<sup>2</sup>

TERRACE AREA : 3,59 m<sup>2</sup>

TOTAL FLAT AREA : 33 m<sup>2</sup>



3RD FLOOR

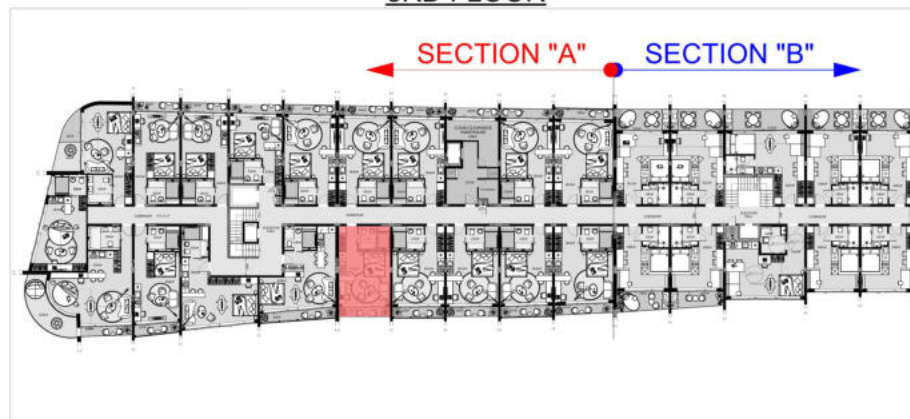

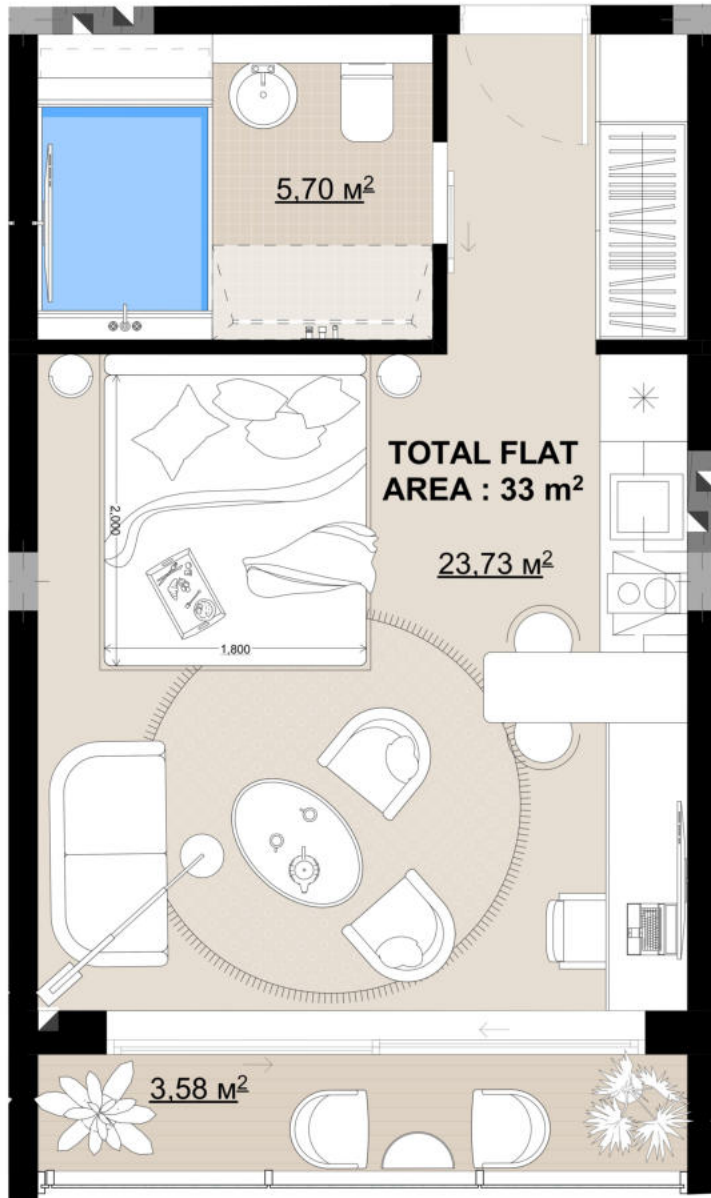

### SECTION "A"

UNIT 76

FLAT AREA : 29,43 m<sup>2</sup>

TERRACE AREA : 3,58 m<sup>2</sup>

TOTAL FLAT AREA : 33 m<sup>2</sup>



3RD FLOOR

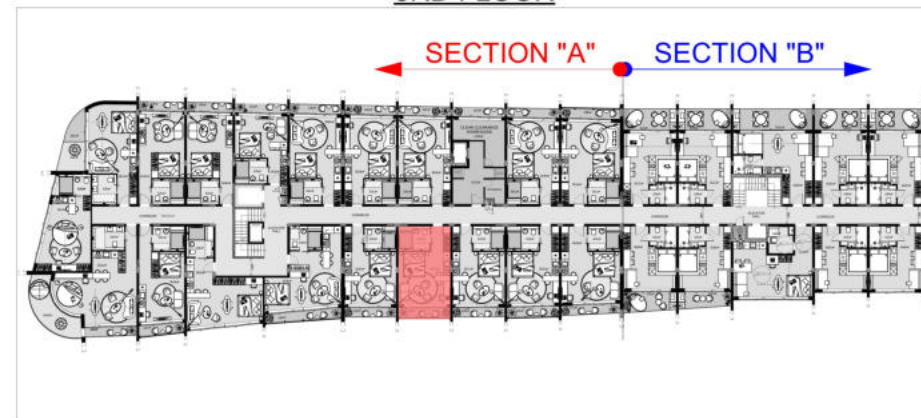

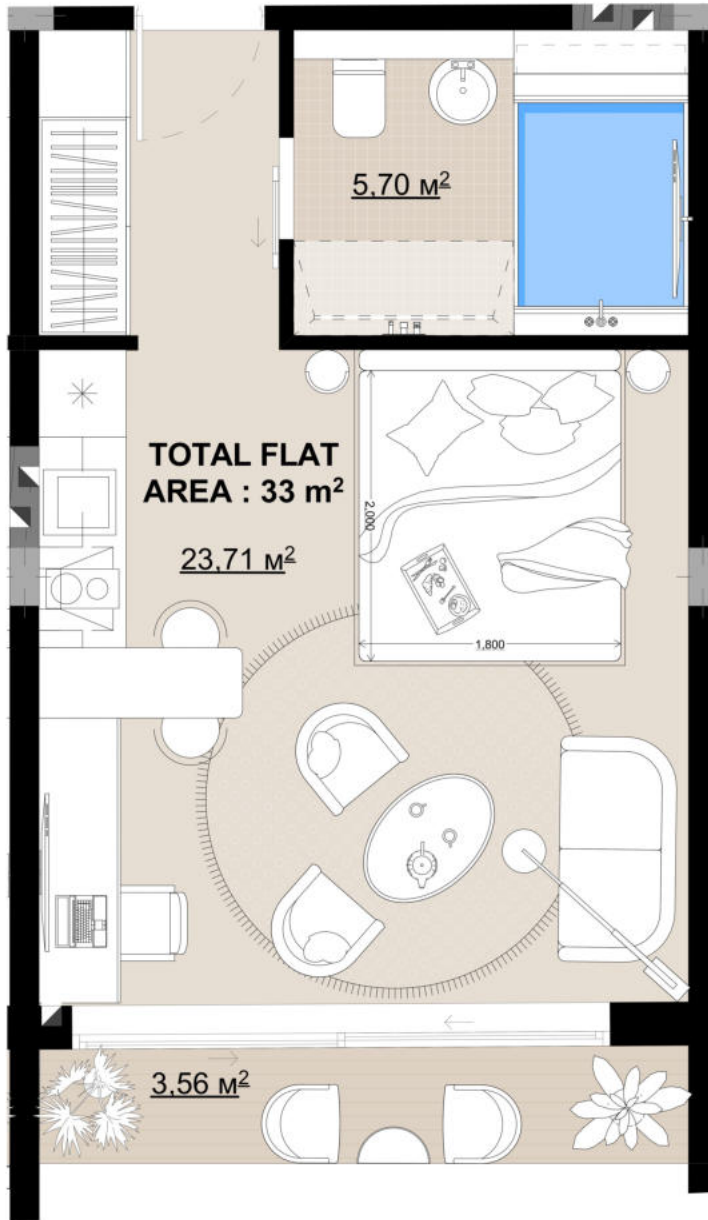

## SECTION "A"

UNIT 75

FLAT AREA : 29,41 m<sup>2</sup>

TERRACE AREA : 3,56 m<sup>2</sup>

TOTAL FLAT AREA : 33 m<sup>2</sup>



3RD FLOOR

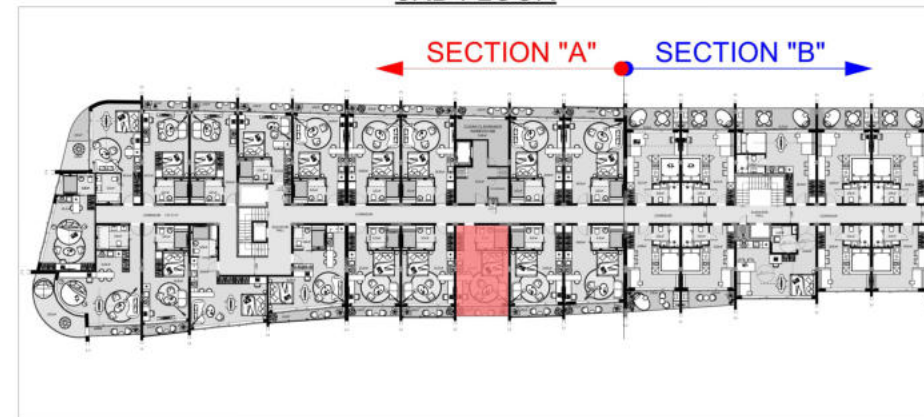

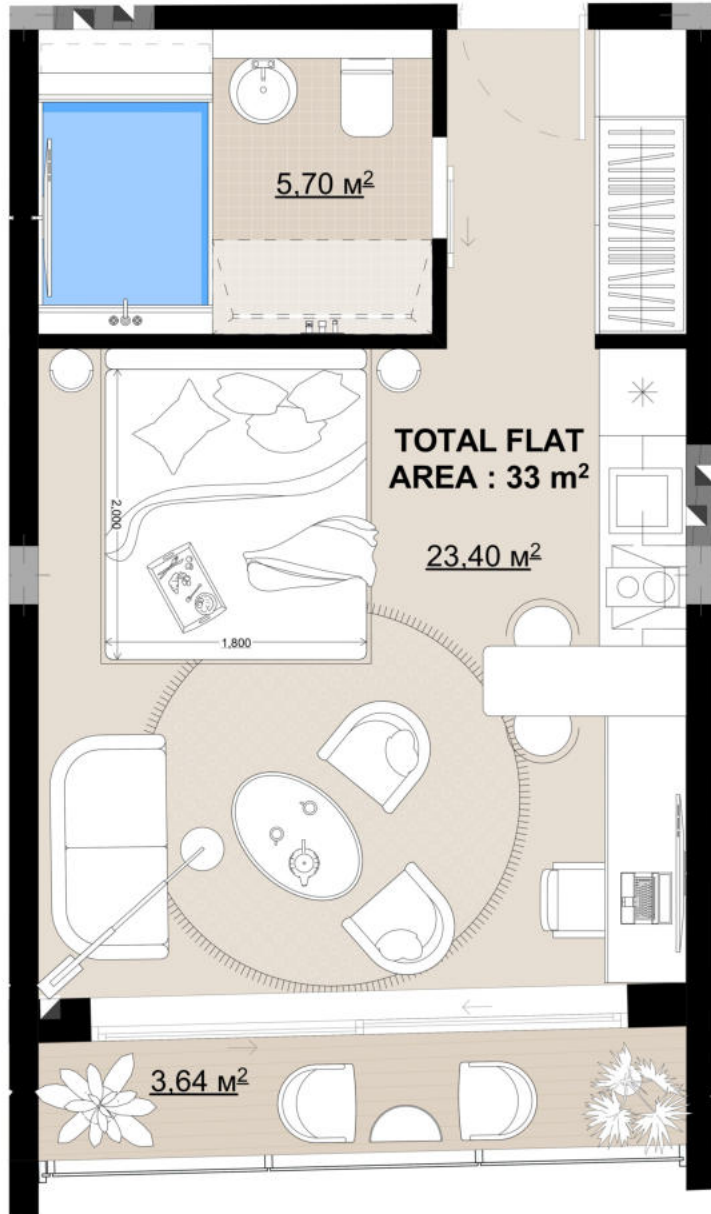

## SECTION "A"

UNIT 74

FLAT AREA : 29,1 m<sup>2</sup>

TERRACE AREA : 3,64 m<sup>2</sup>

TOTAL FLAT AREA : 33 m<sup>2</sup>



3RD FLOOR

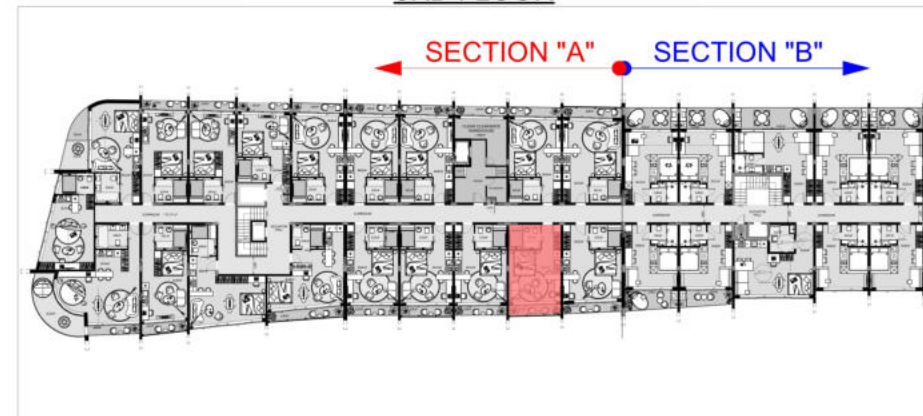

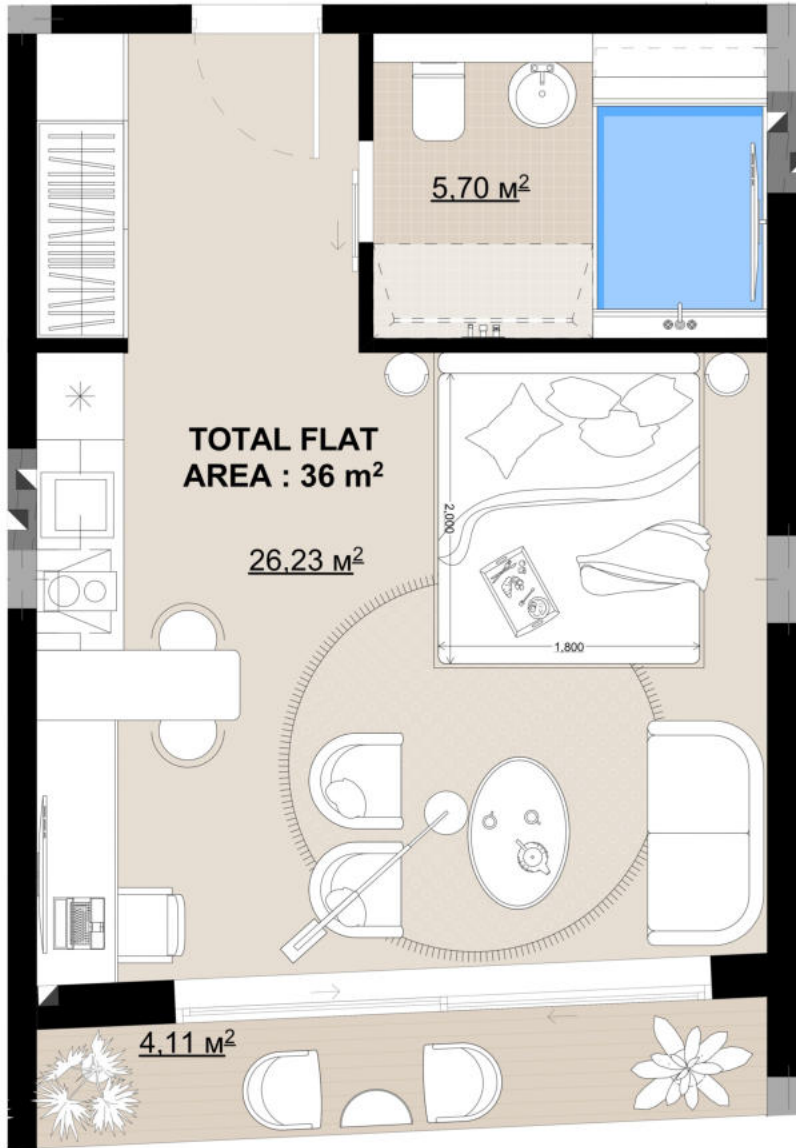

## SECTION "A"

UNIT 73

FLAT AREA : 31.93 m<sup>2</sup>

TERRACE AREA : 4,11 m<sup>2</sup>

TOTAL FLAT AREA : 36 m<sup>2</sup>



3RD FLOOR

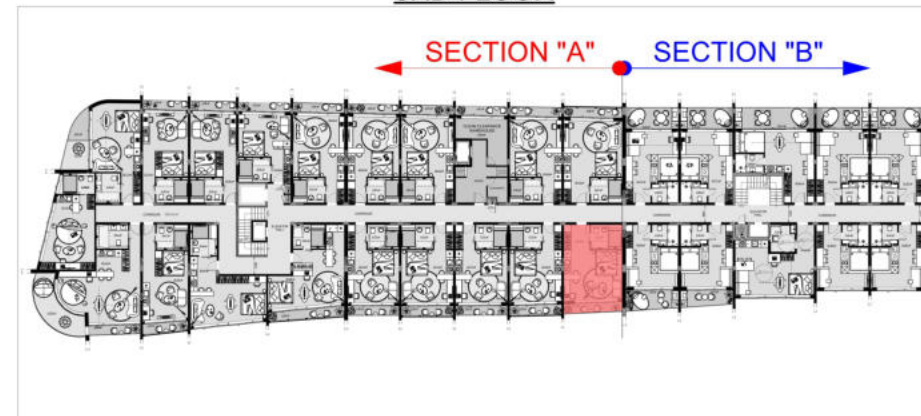

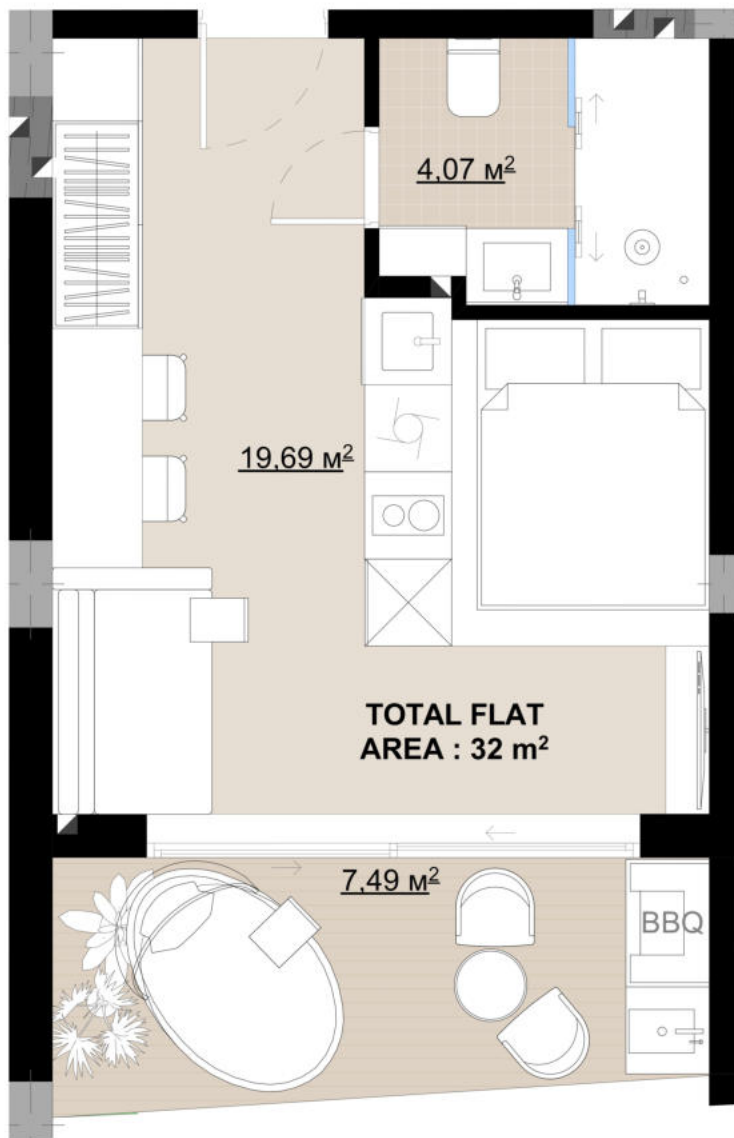

## SECTION "B"

SUITE 72

FLAT AREA : 23,68 m<sup>2</sup>

TERRACE AREA : 7,49 m<sup>2</sup>

TOTAL FLAT AREA : 32 m<sup>2</sup>



3RD FLOOR

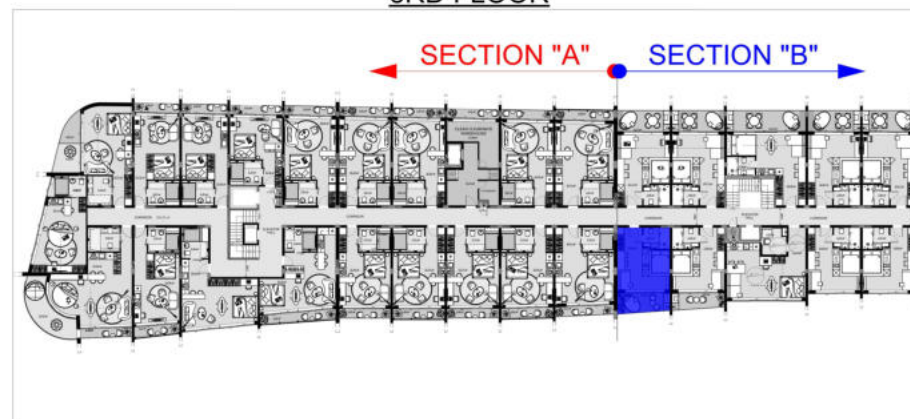

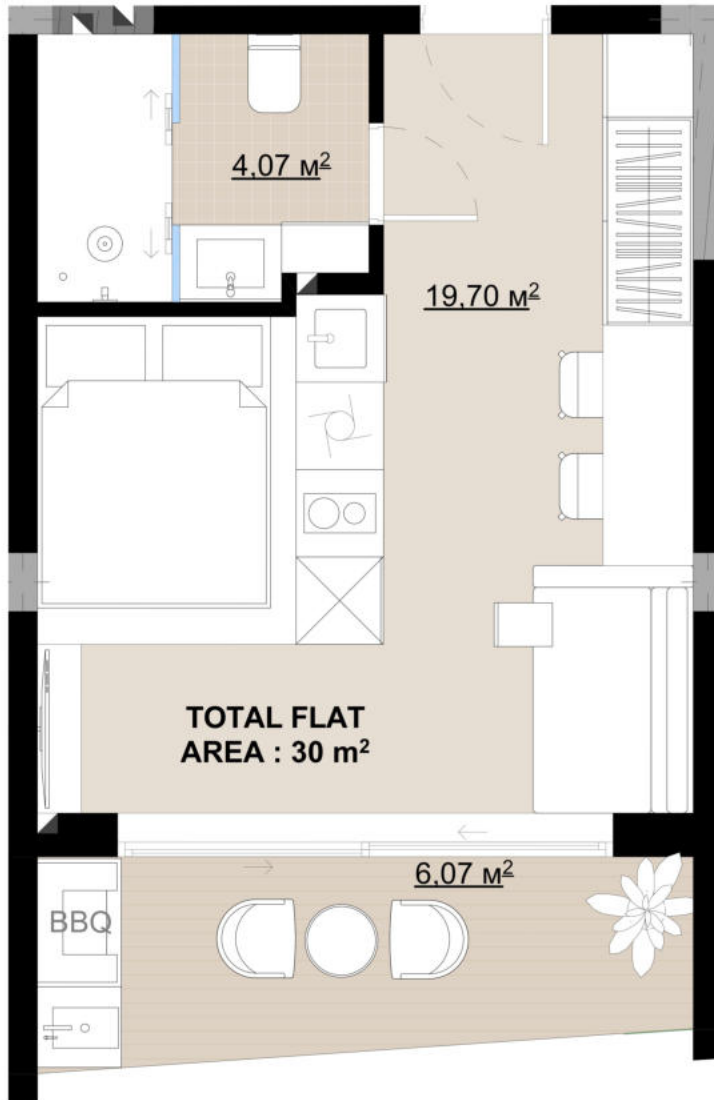

## SECTION "B"

SUITE 71

FLAT AREA : 23,5 m<sup>2</sup>

TERRACE AREA : 6,07 m<sup>2</sup>

TOTAL FLAT AREA : 30 m<sup>2</sup>



3RD FLOOR

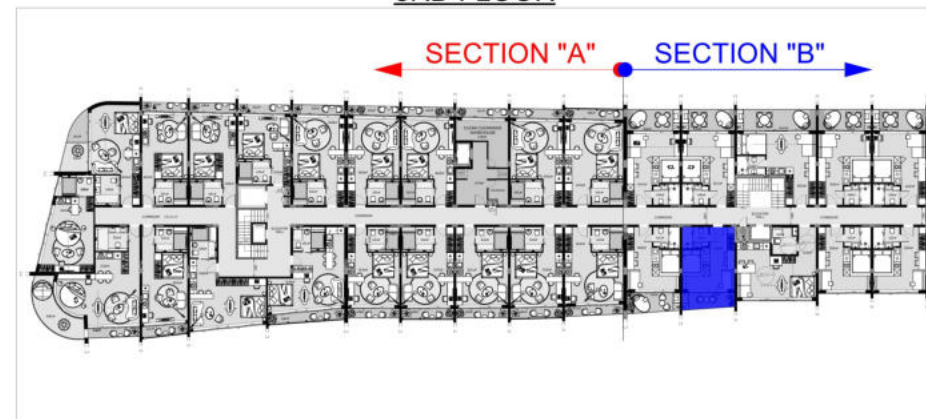



### SECTION "B"

SUITE 70

FLAT AREA : 36,5 m<sup>2</sup>

TERRACE AREA : 0 m<sup>2</sup>

TOTAL FLAT AREA : 36,5 m<sup>2</sup>

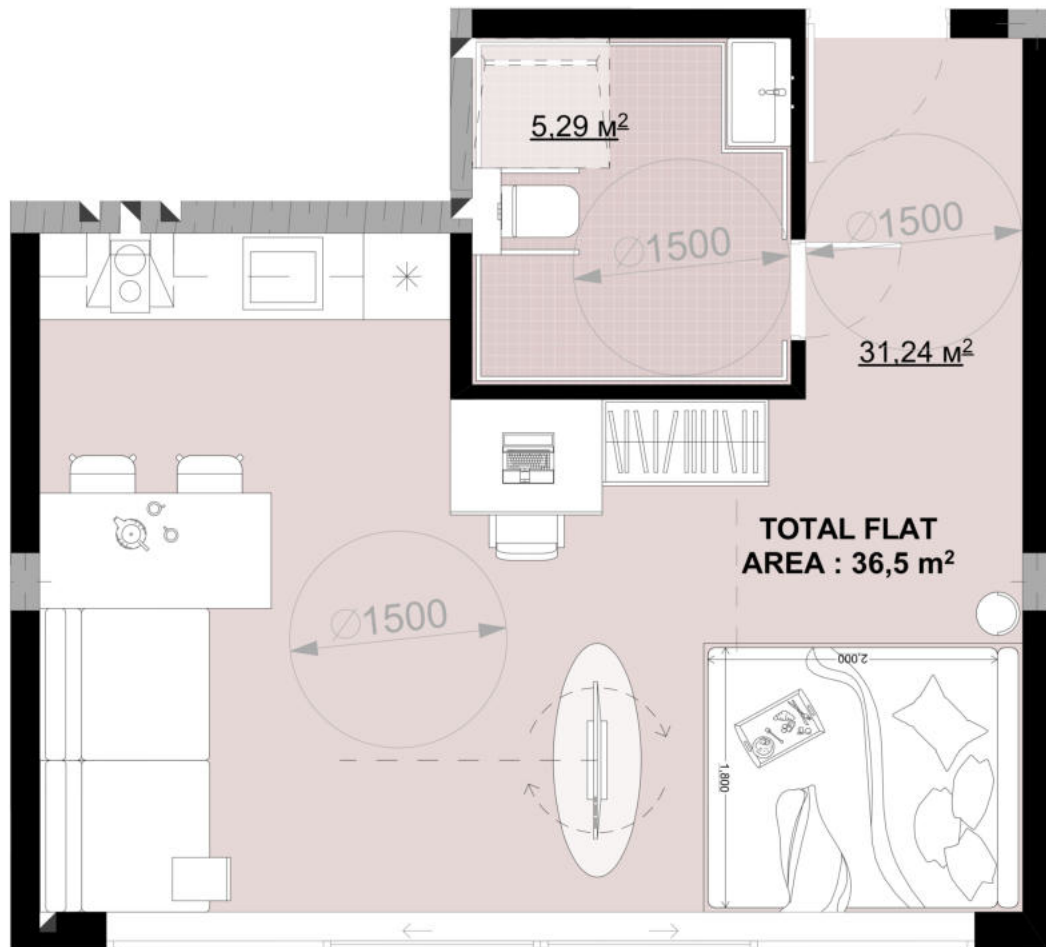

3RD FLOOR

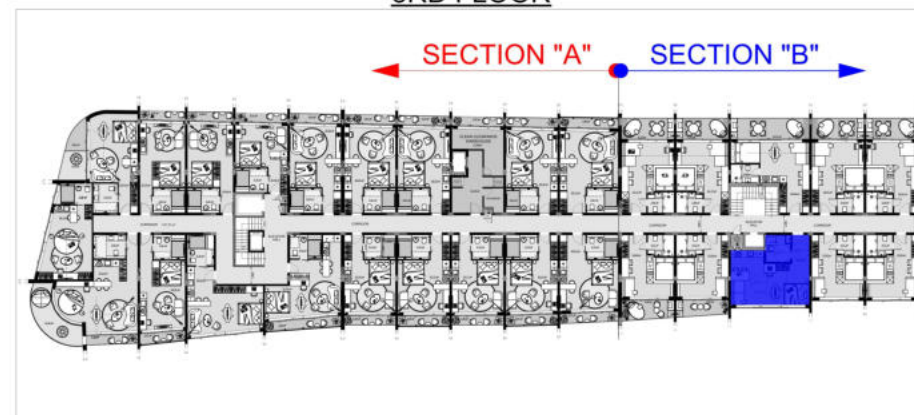

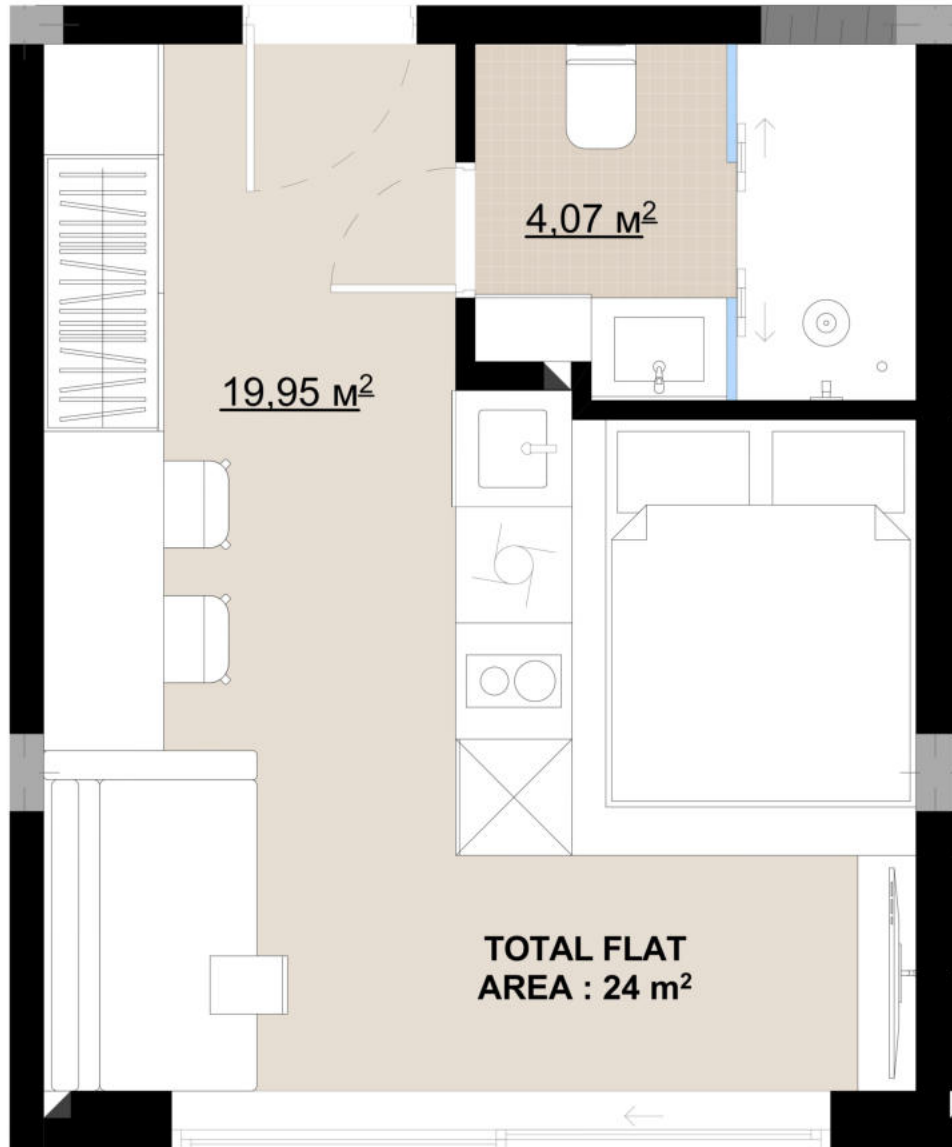

## SECTION "B"

UNIT 69

FLAT AREA : 24 m<sup>2</sup>

TERRACE AREA : 0 m<sup>2</sup>

TOTAL FLAT AREA : 24 m<sup>2</sup>



3RD FLOOR

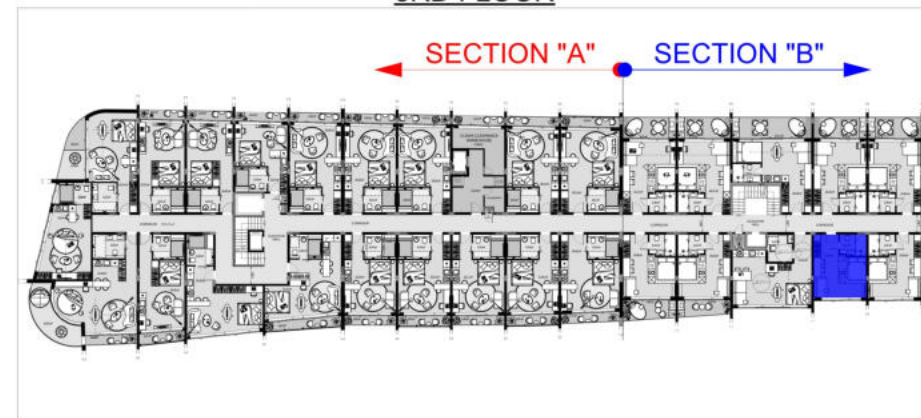



## SECTION "B"

UNIT 68

FLAT AREA : 24 m<sup>2</sup>

TERRACE AREA : 0 m<sup>2</sup>

TOTAL FLAT AREA : 24 m<sup>2</sup>

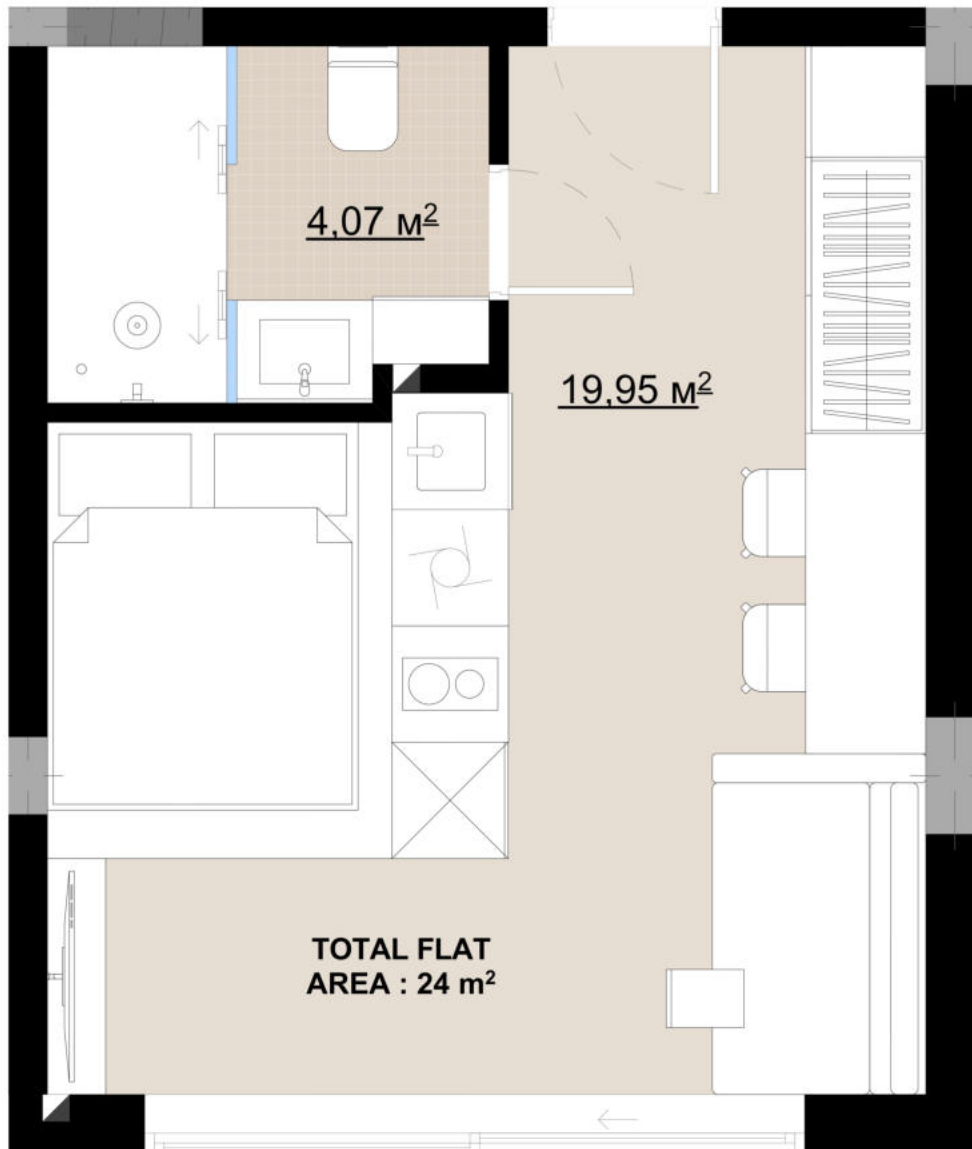

3RD FLOOR

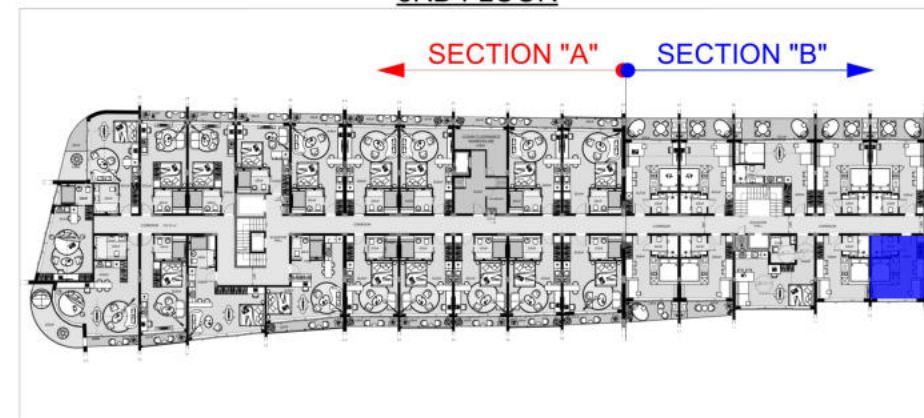

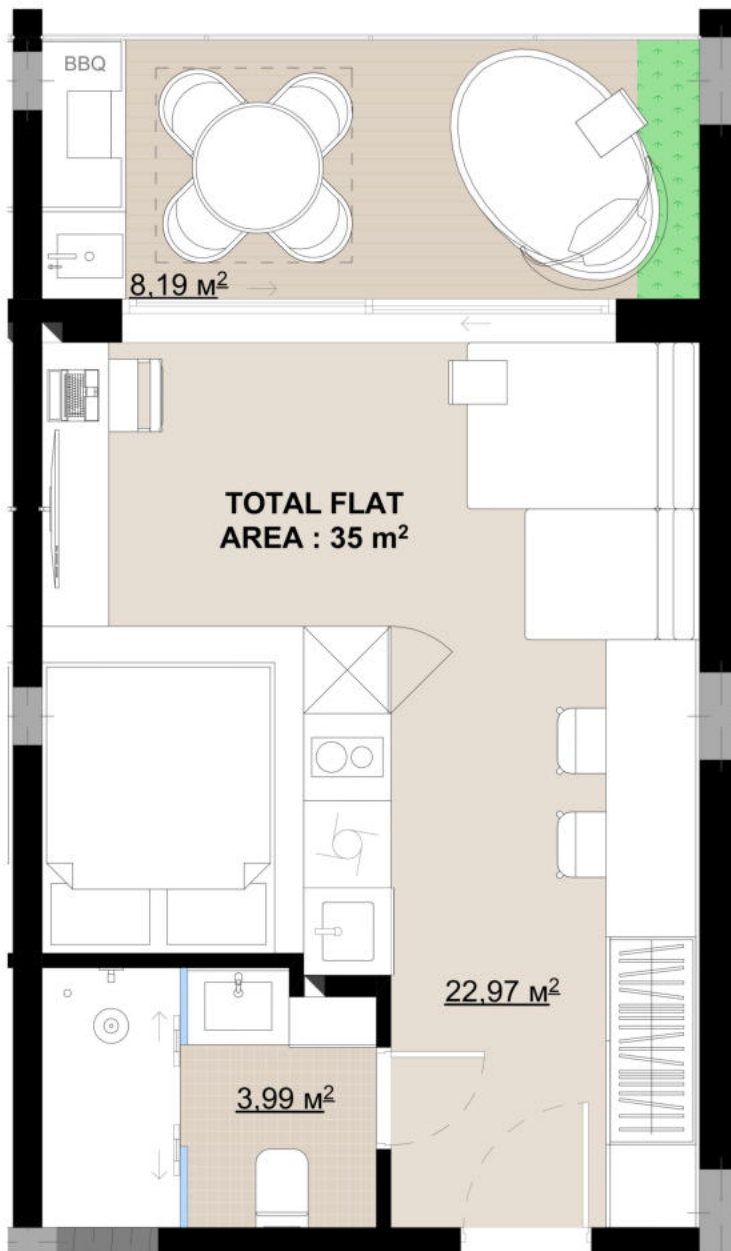

## SECTION "B"

UNIT 67

FLAT AREA : 26,96 m<sup>2</sup>

TERRACE AREA : 8,19 m<sup>2</sup>

TOTAL FLAT AREA : 35 m<sup>2</sup>



3RD FLOOR

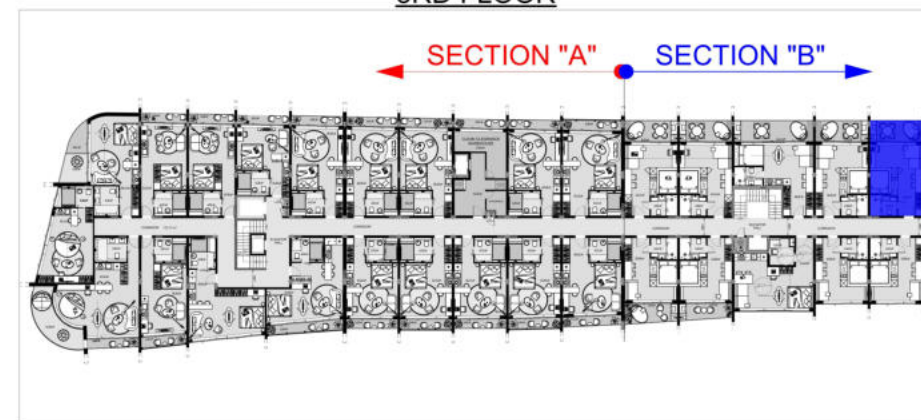

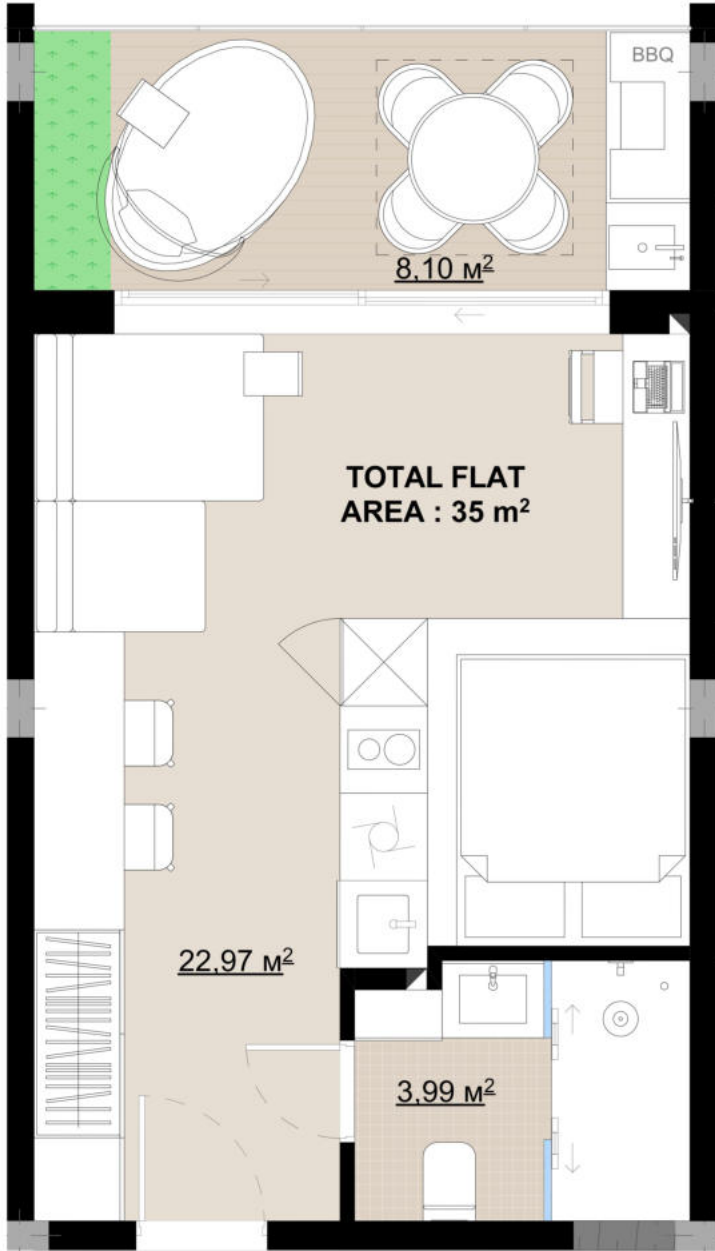

## SECTION "B"

UNIT 66

FLAT AREA :  $26,96 \text{ m}^2$

TERRACE AREA :  $8,10 \text{ m}^2$

TOTAL FLAT AREA :  $35 \text{ m}^2$



3RD FLOOR

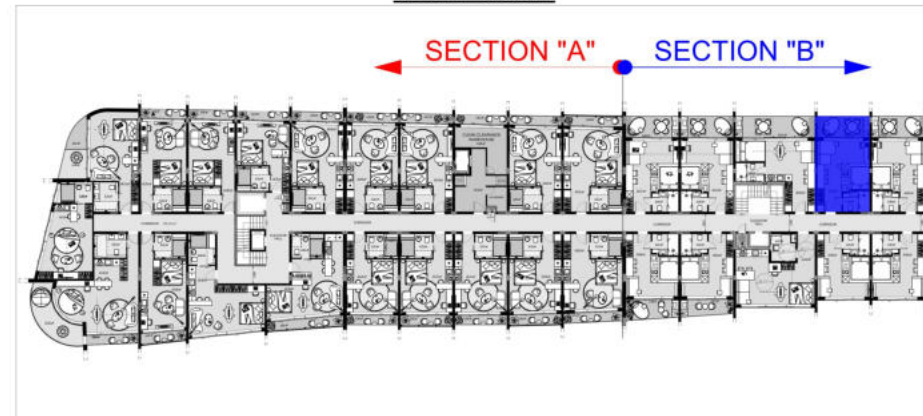

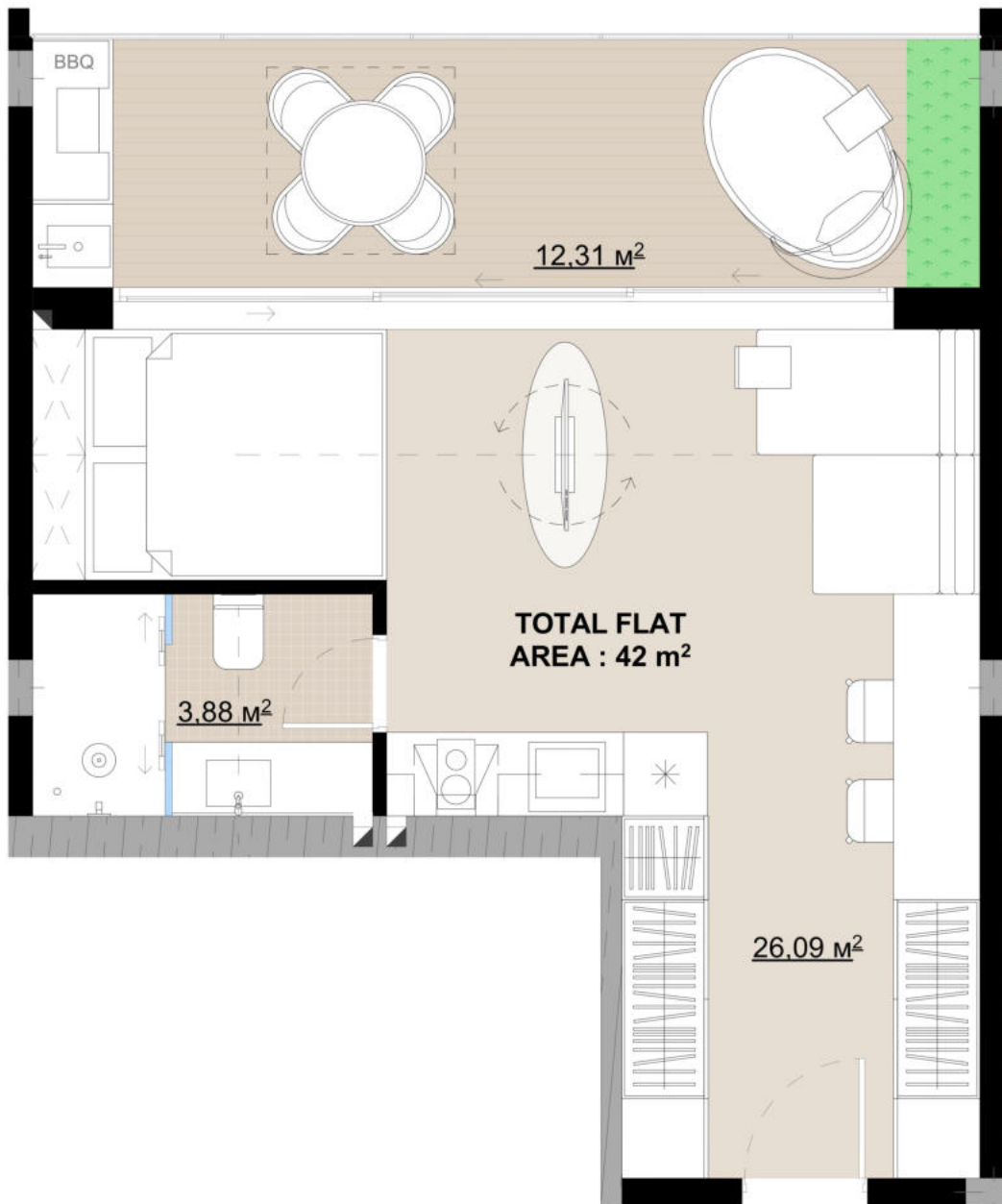

## SECTION "B"

UNIT 65

FLAT AREA : 29,97 m<sup>2</sup>

TERRACE AREA : 12,31 m<sup>2</sup>

TOTAL FLAT AREA : 42 m<sup>2</sup>



3RD FLOOR

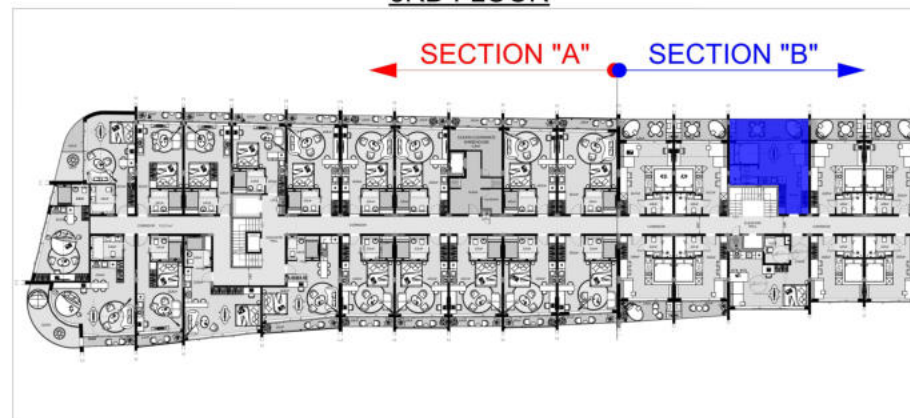

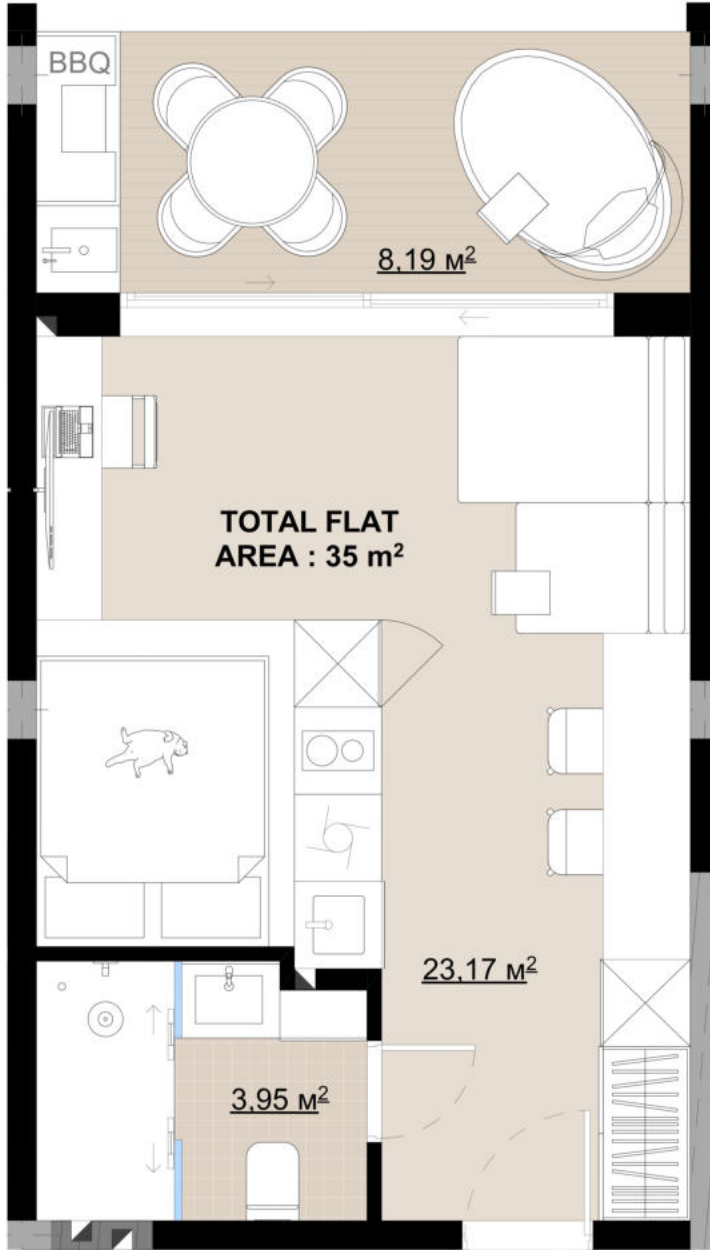

## SECTION "B"

UNIT 64

FLAT AREA : 27,12 m<sup>2</sup>

TERRACE AREA : 8,19 m<sup>2</sup>

TOTAL FLAT AREA : 35 m<sup>2</sup>



3RD FLOOR

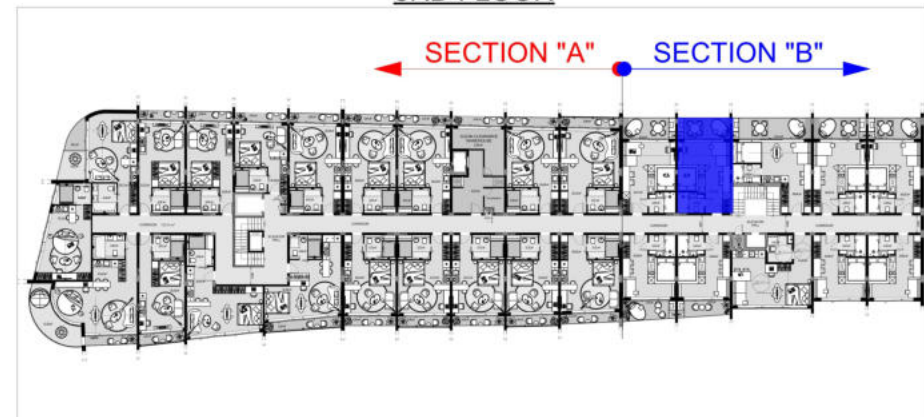



## SECTION "B"

UNIT 63

FLAT AREA : 27,12 m<sup>2</sup>

TERRACE AREA : 8,19 m<sup>2</sup>

TOTAL FLAT AREA : 35 m<sup>2</sup>

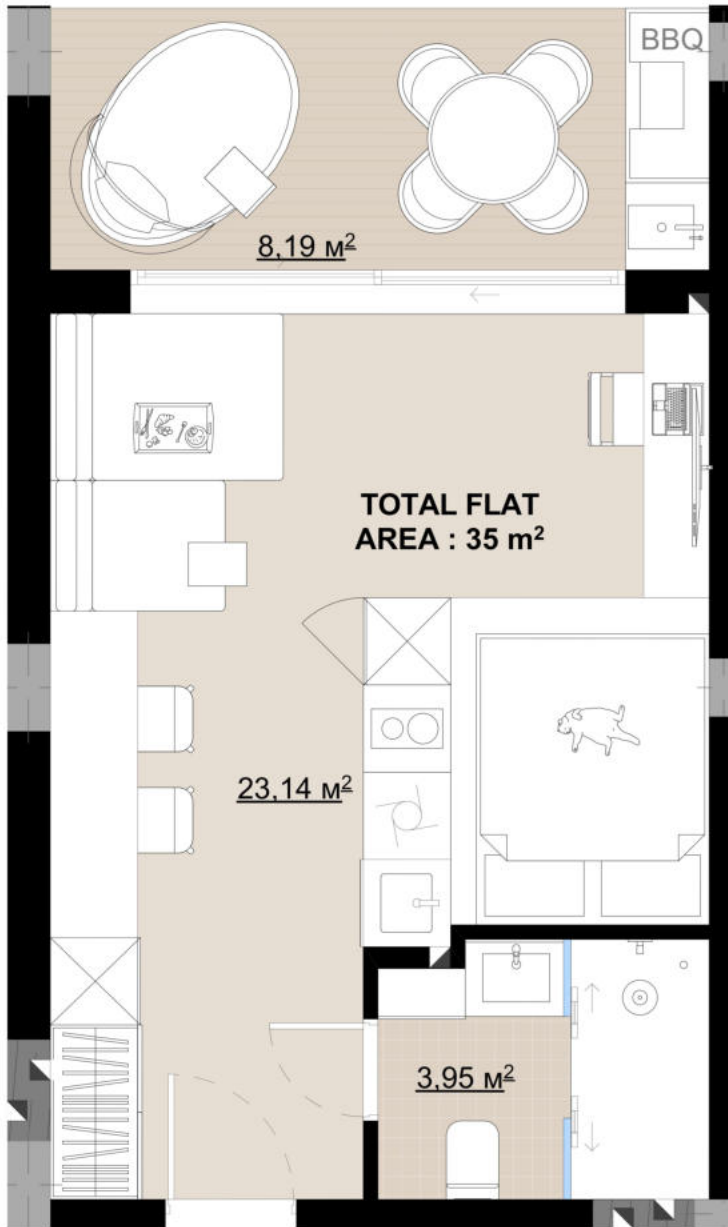

3RD FLOOR

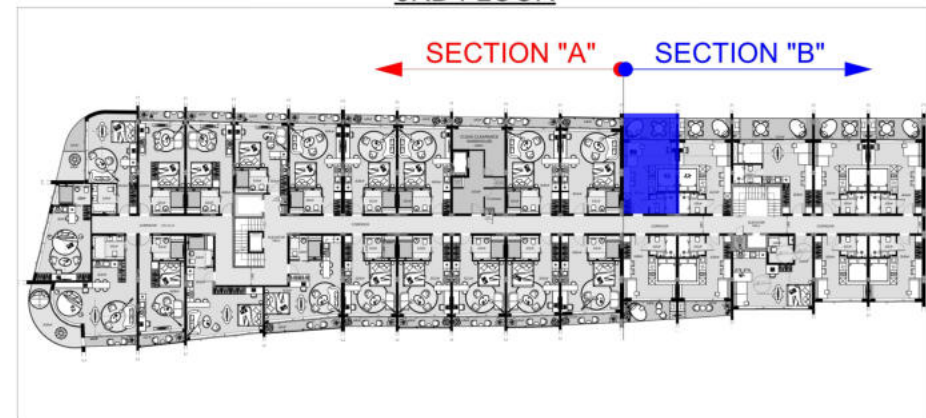

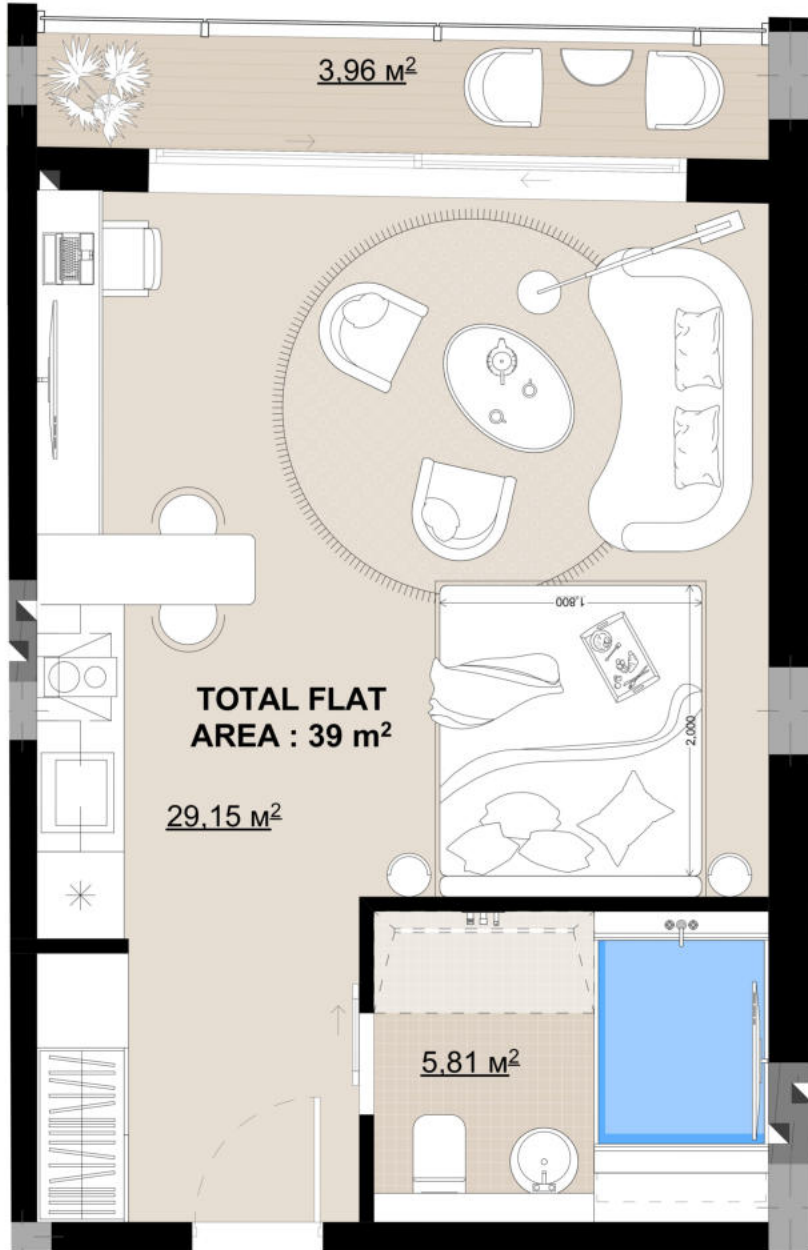

### SECTION "A"

UNIT 62

FLAT AREA : 34,96 m<sup>2</sup>

TERRACE AREA : 3.96 m<sup>2</sup>

TOTAL FLAT AREA : 39 m<sup>2</sup>



3RD FLOOR

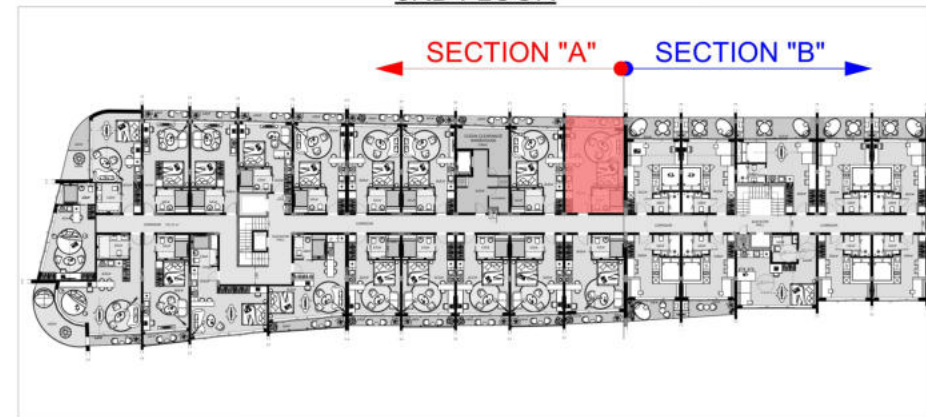

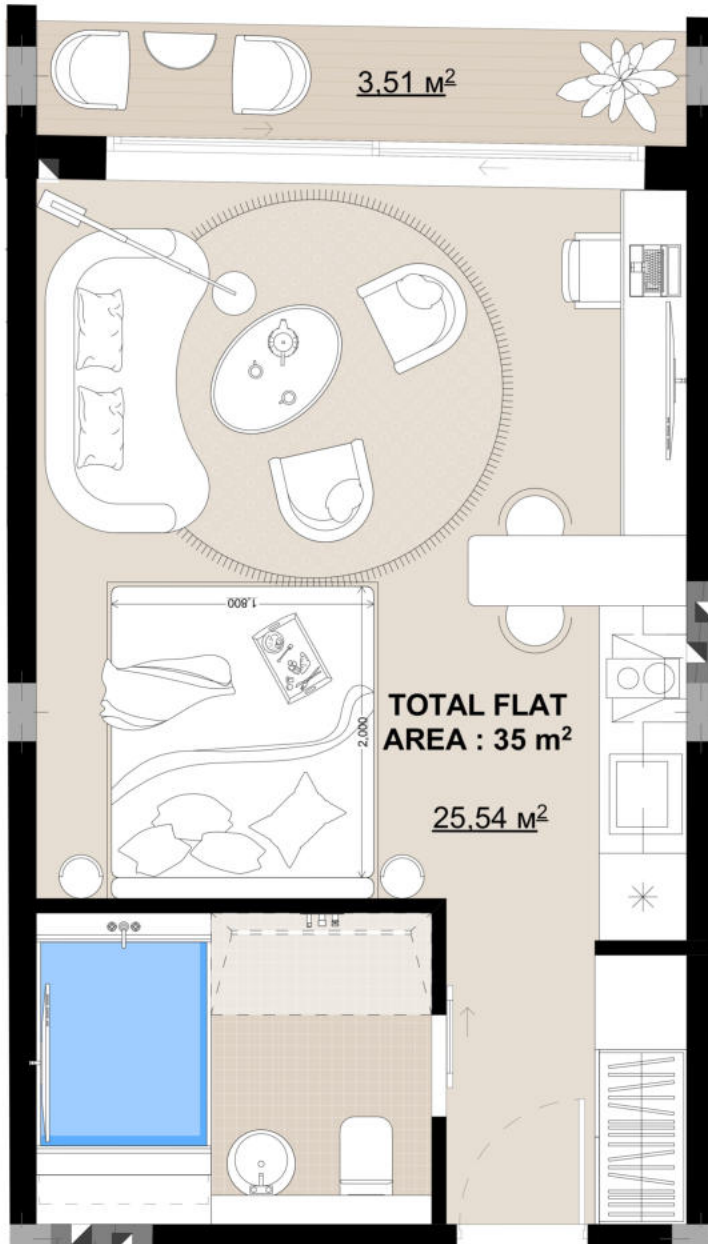

### SECTION "A"

UNIT 61

FLAT AREA : 31.35 m<sup>2</sup>

TERRACE AREA : 3.51 m<sup>2</sup>

TOTAL FLAT AREA : 35 m<sup>2</sup>



3RD FLOOR

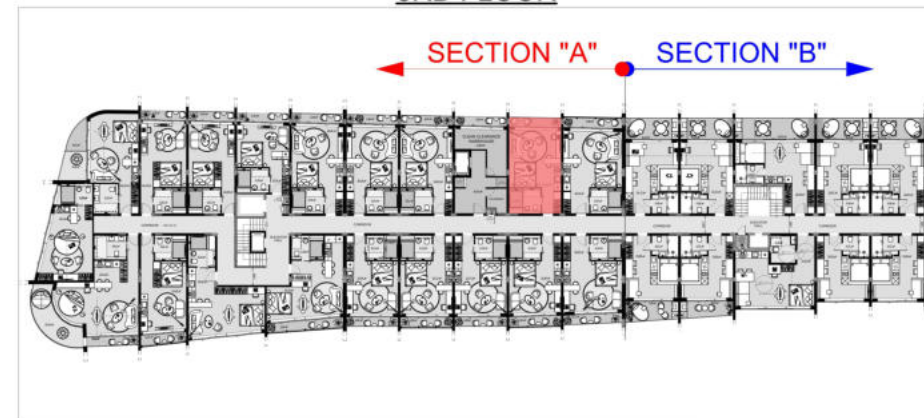

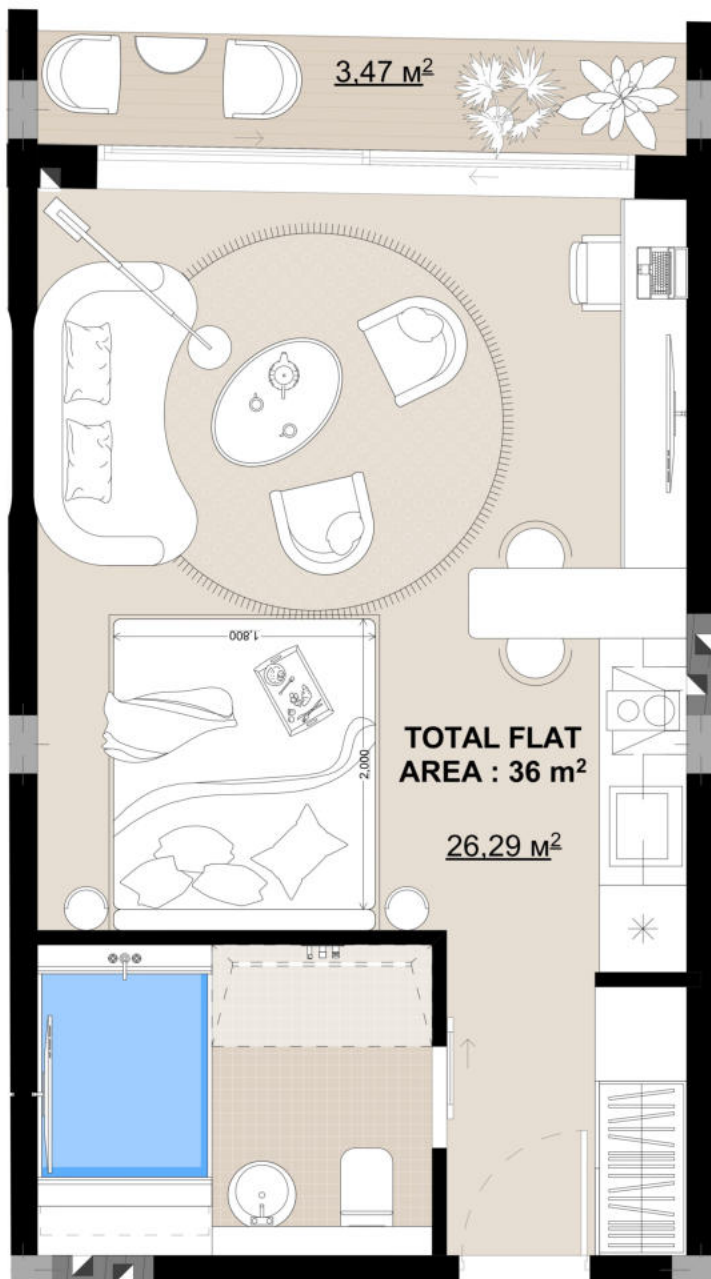

## SECTION "A"

UNIT 60

FLAT AREA : 32,1 m<sup>2</sup>

TERRACE AREA : 3,47 m<sup>2</sup>

TOTAL FLAT AREA : 36 m<sup>2</sup>



3RD FLOOR

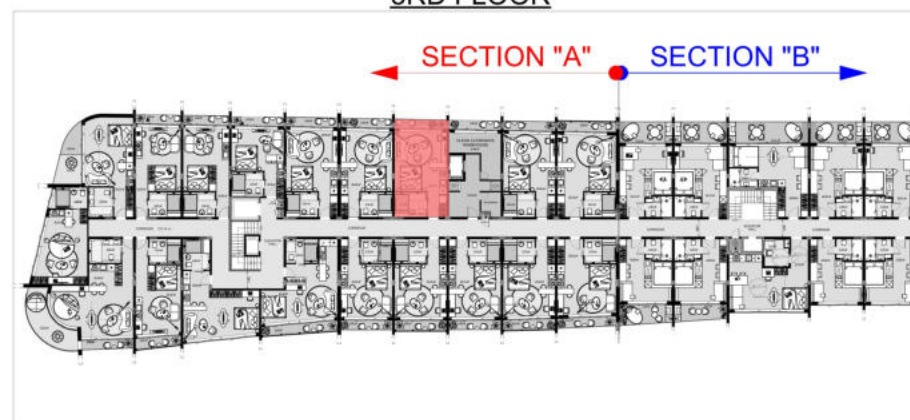

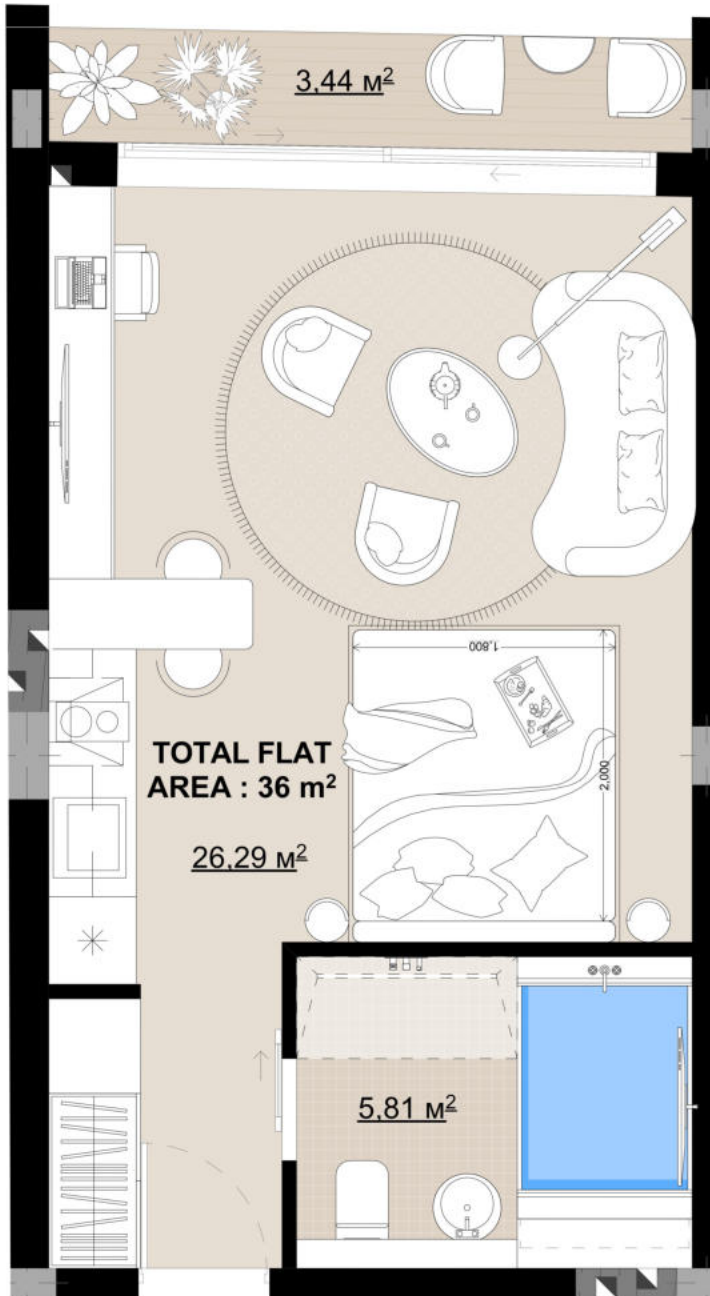

## SECTION "A"

UNIT 59

FLAT AREA : 32,1 m<sup>2</sup>

TERRACE AREA : 3,44 m<sup>2</sup>

TOTAL FLAT AREA : 36 m<sup>2</sup>



3RD FLOOR

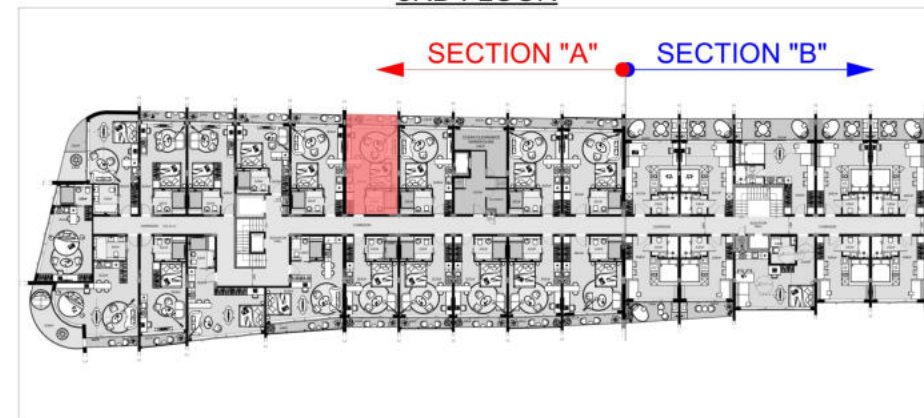

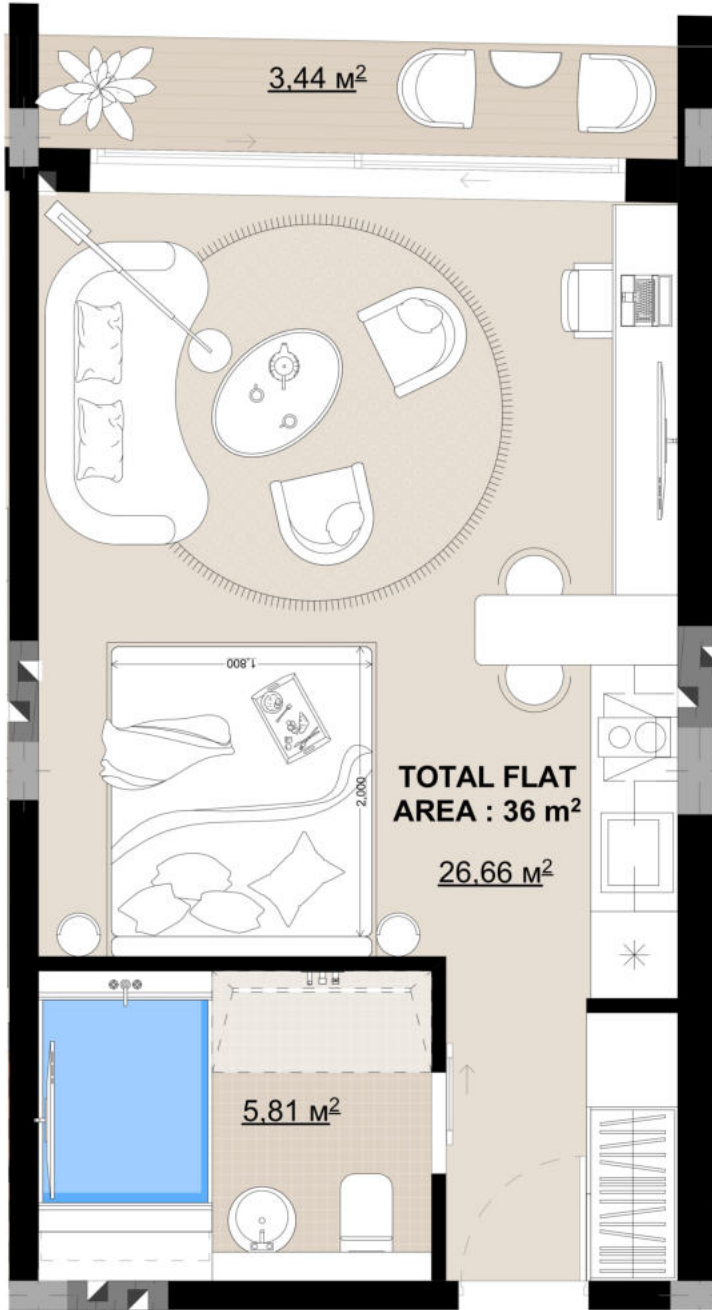

### SECTION "A"

UNIT 58

FLAT AREA : 32,47 m<sup>2</sup>

TERRACE AREA : 3,44 m<sup>2</sup>

TOTAL FLAT AREA : 36 m<sup>2</sup>



3RD FLOOR

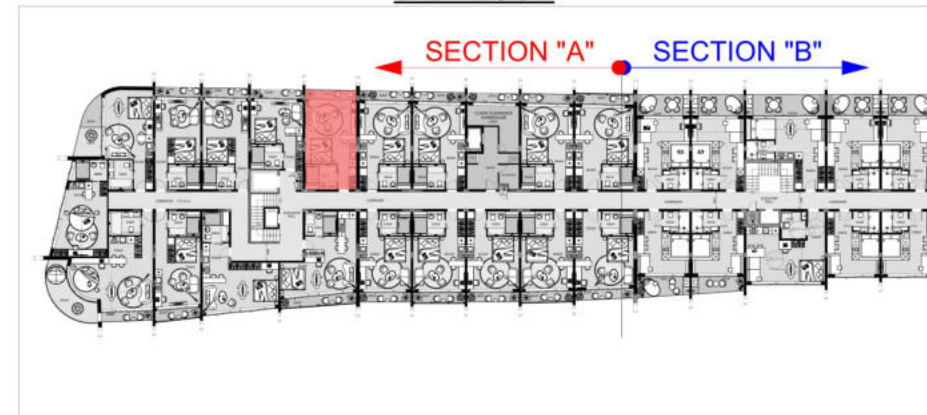

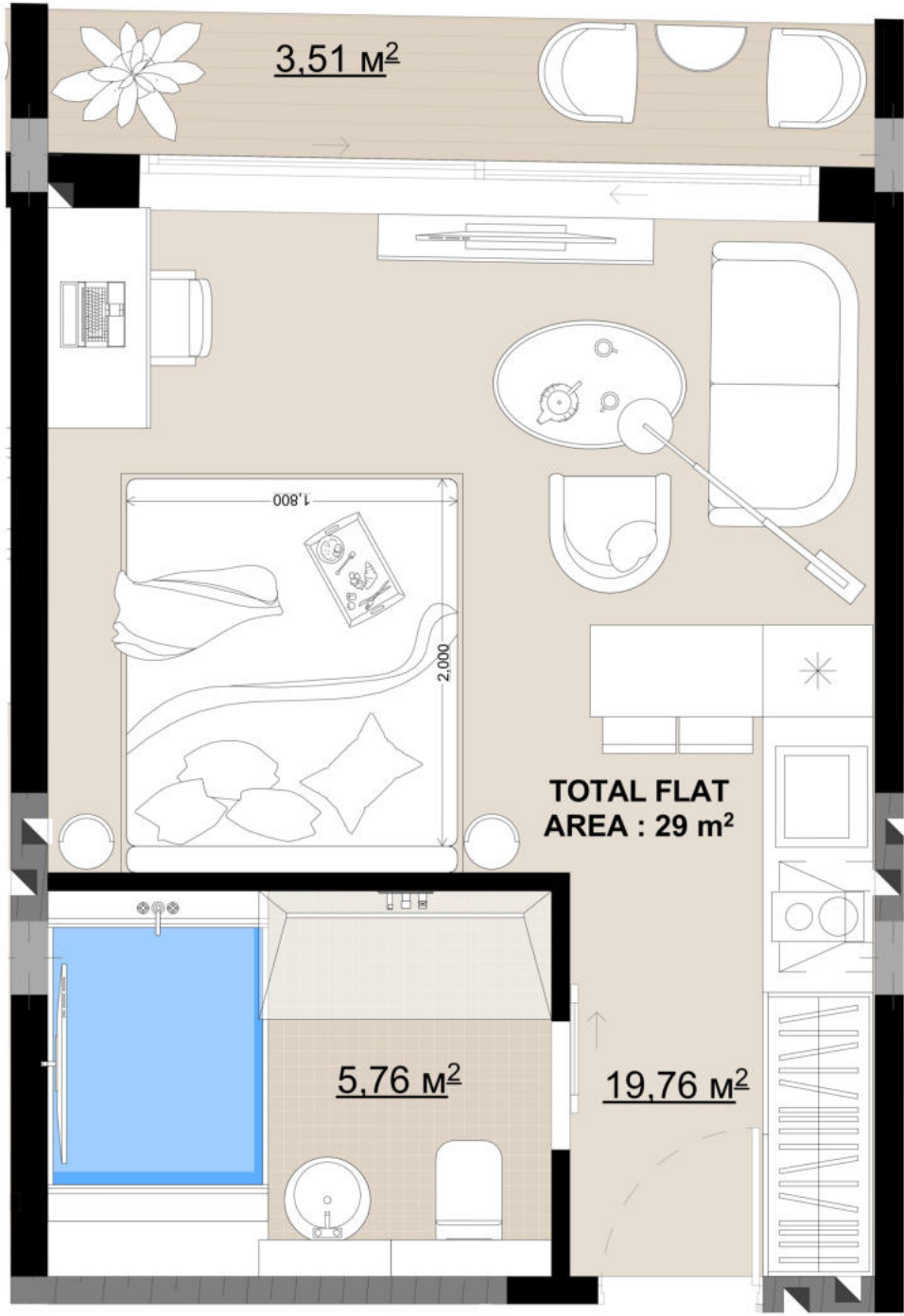

**SECTION "A"**

UNIT 57

FLAT AREA : 25.52 m<sup>2</sup>

TERRACE AREA : 3.51 m<sup>2</sup>

TOTAL FLAT AREA : 29 m<sup>2</sup>



3RD FLOOR

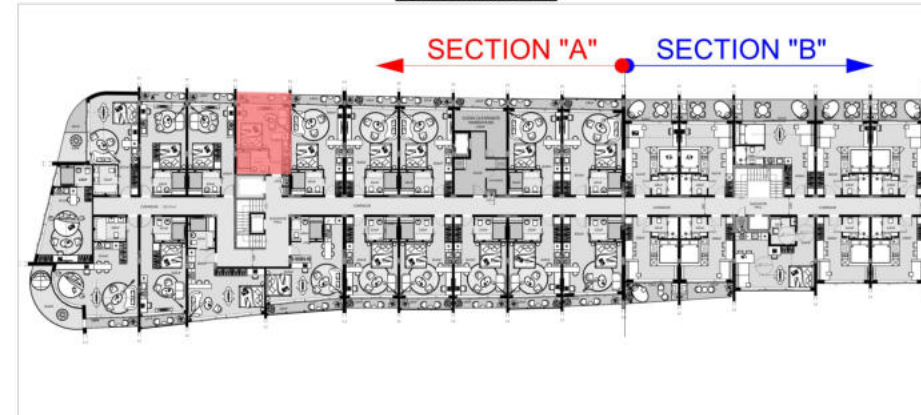

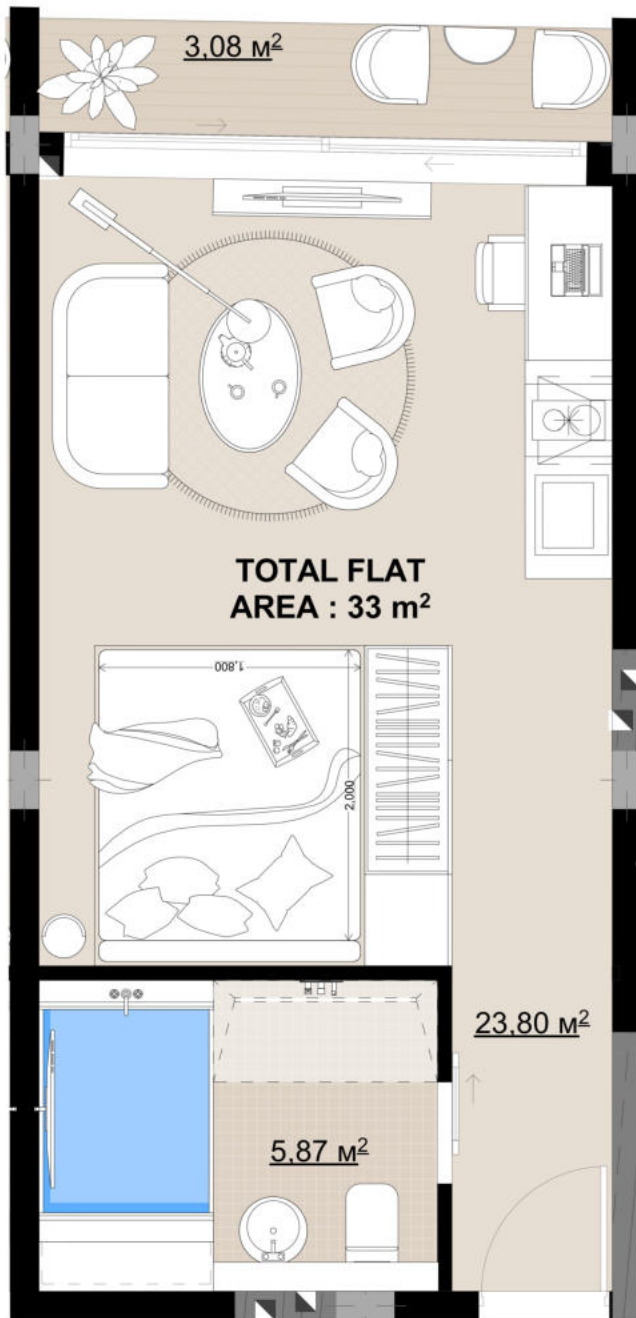

## SECTION "A"

UNIT 56

FLAT AREA : 29,67 m<sup>2</sup>

TERRACE AREA : 3,08 m<sup>2</sup>

TOTAL FLAT AREA : 33 m<sup>2</sup>



3RD FLOOR

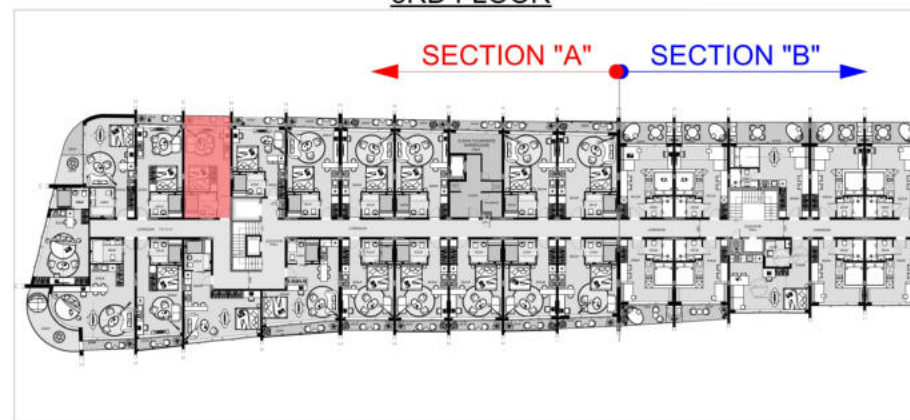

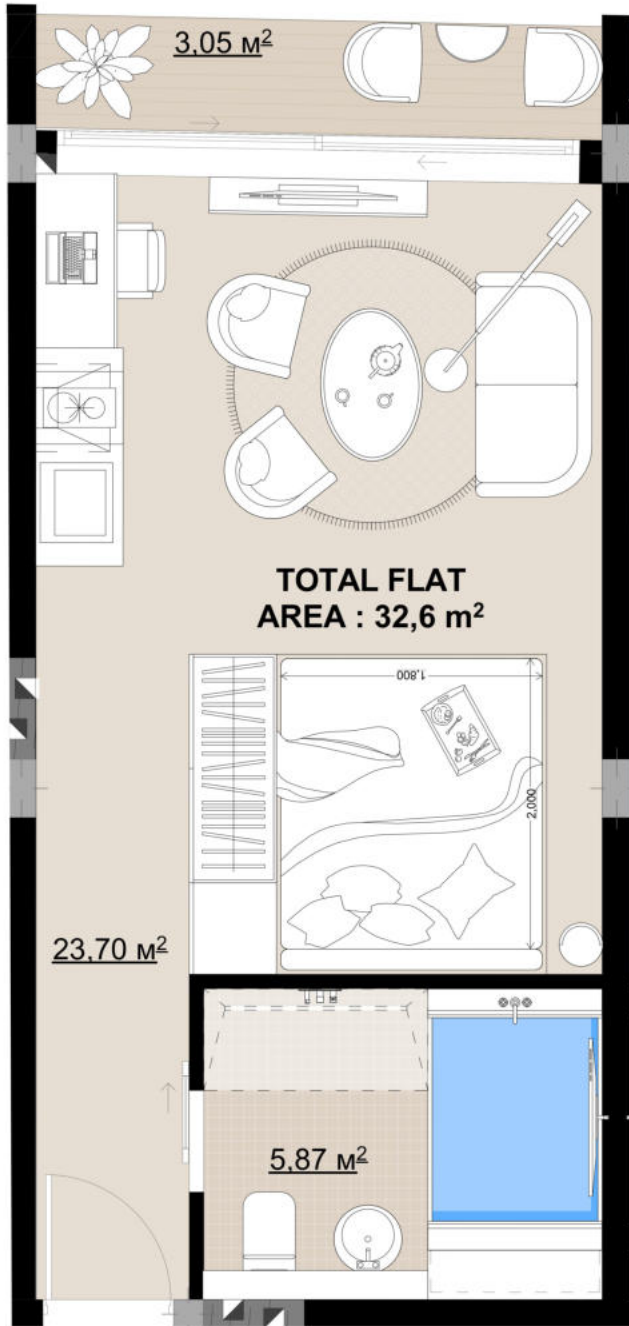

## SECTION "A"

UNIT 55

FLAT AREA : 29,57 m<sup>2</sup>

TERRACE AREA : 3.05 m<sup>2</sup>

**TOTAL FLAT AREA : 32.6 m<sup>2</sup>**



3RD FLOOR

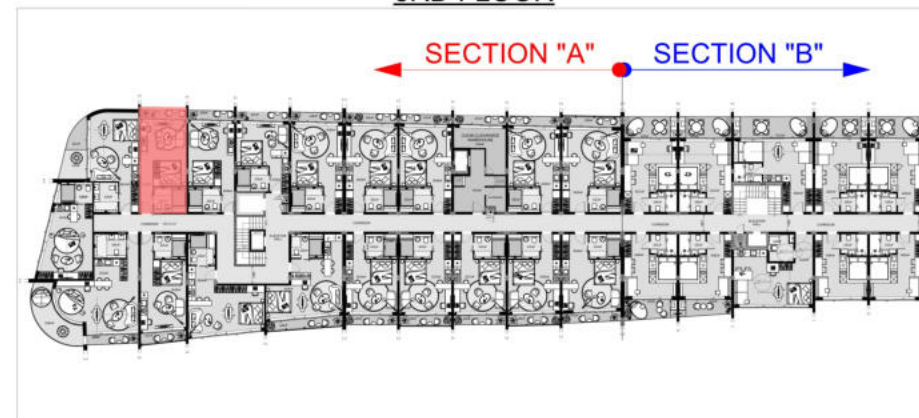

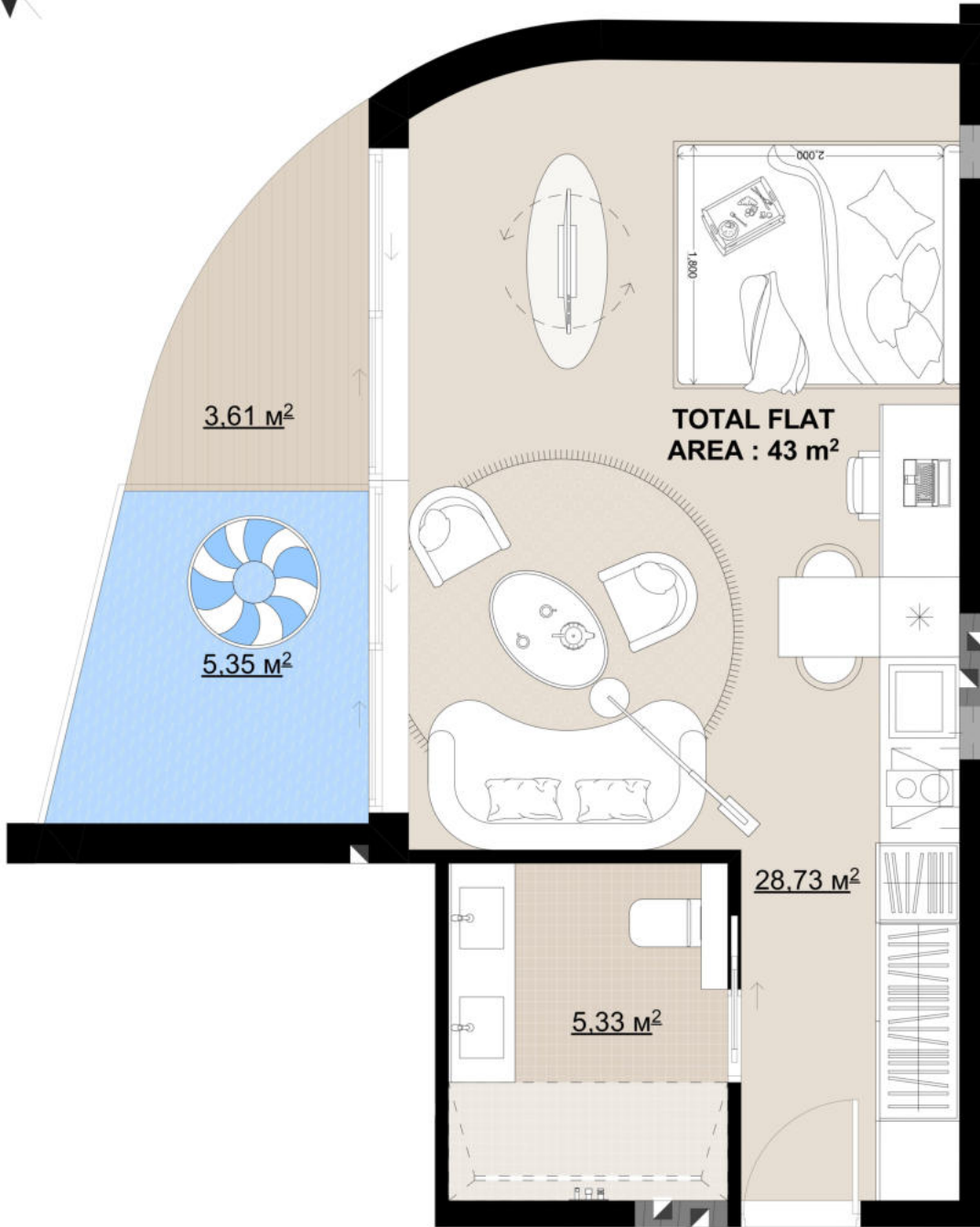

### SECTION "A"

UNIT 54

FLAT AREA : 34 m<sup>2</sup>

TERRACE AREA : 8,96 m<sup>2</sup>

TOTAL FLAT AREA : 43 m<sup>2</sup>



3RD FLOOR

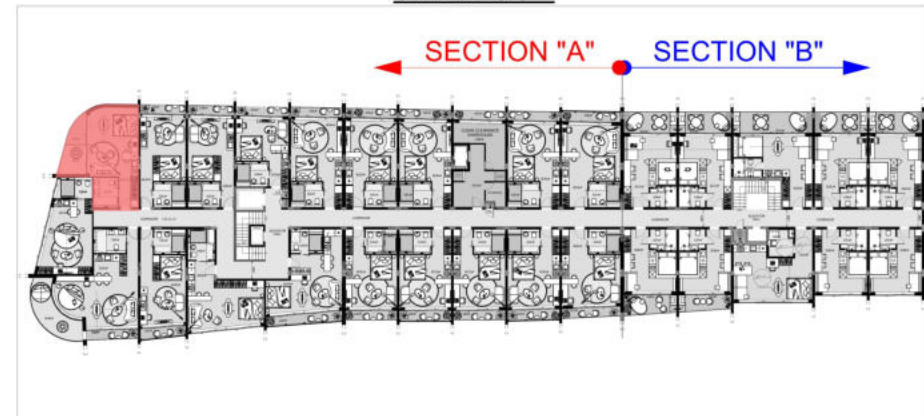

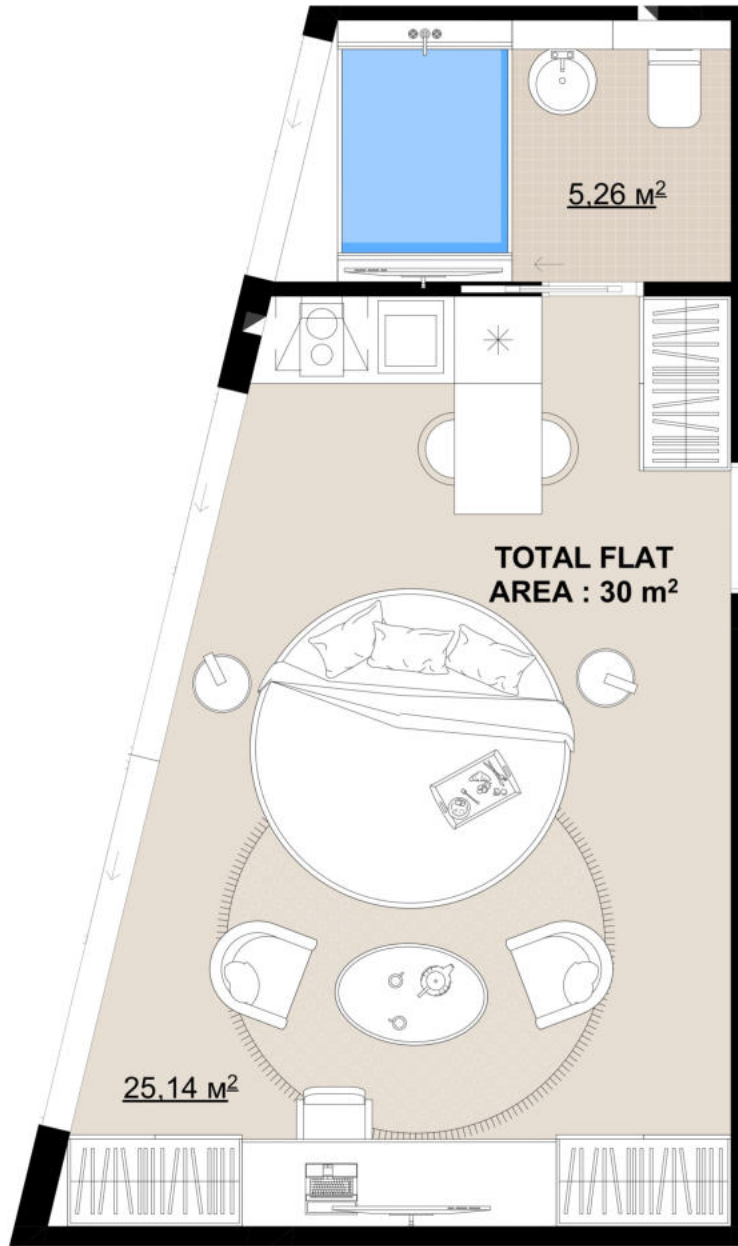

## SECTION "A"

UNIT 53

FLAT AREA : 30 m<sup>2</sup>

TERRACE AREA : 0 m<sup>2</sup>

TOTAL FLAT AREA : 30 m<sup>2</sup>



2ND FLOOR

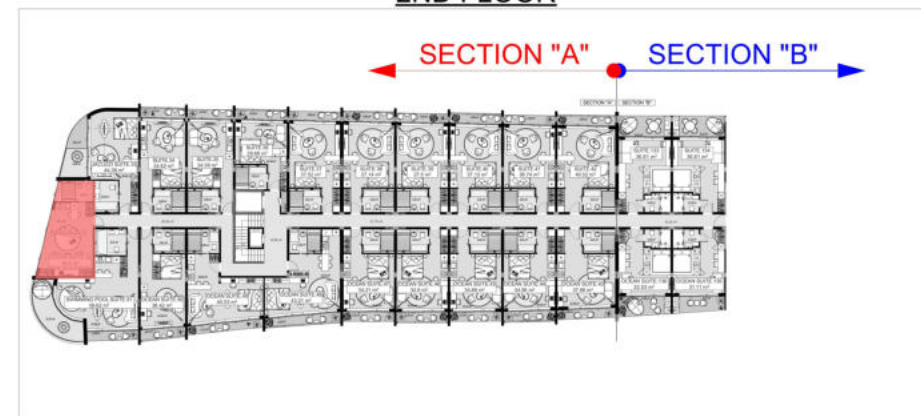

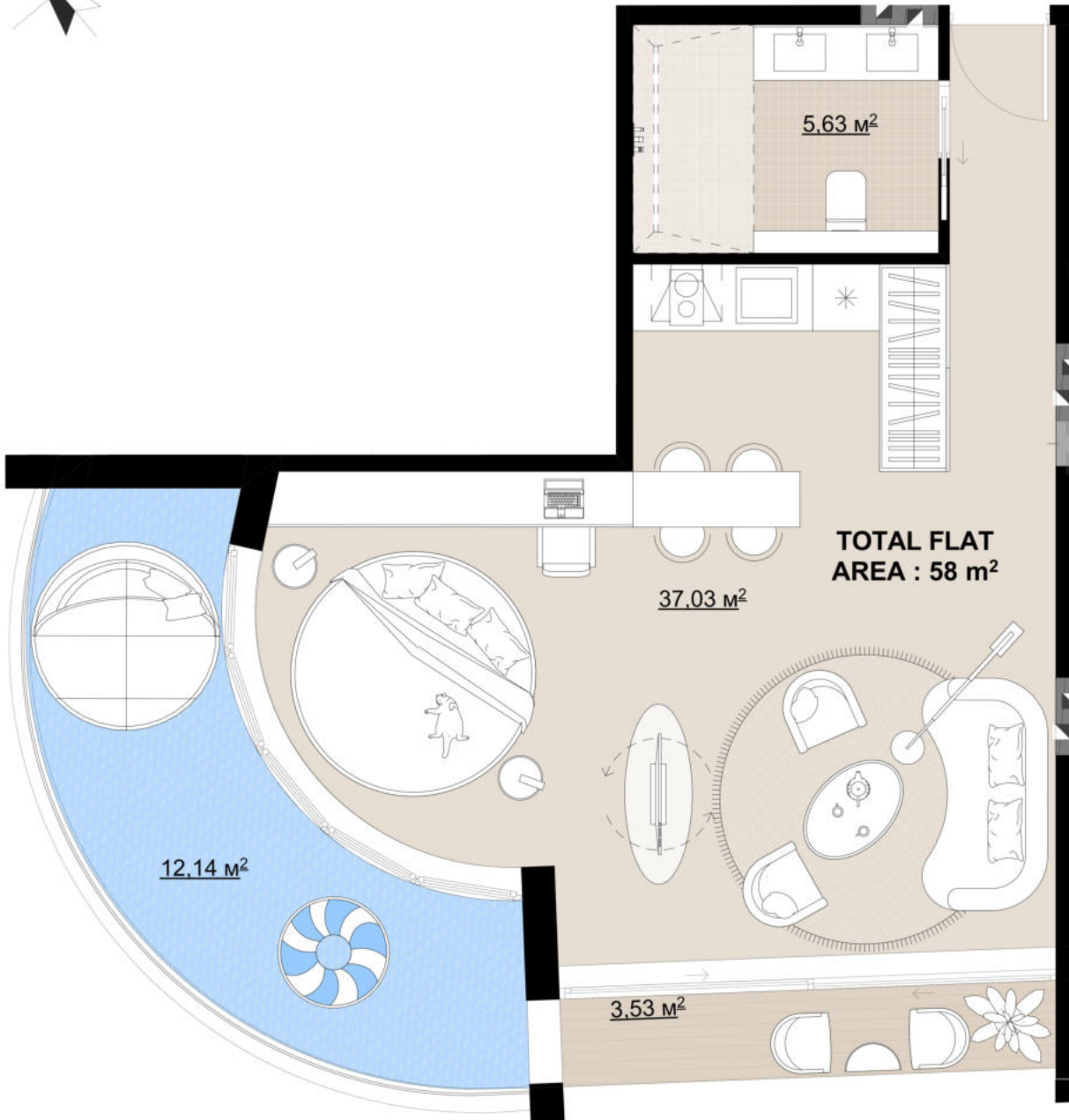

### SECTION "A"

UNIT 52

FLAT AREA : 42,66 m<sup>2</sup>

TERRACE AREA : 15,67 m<sup>2</sup>

TOTAL FLAT AREA : 58 m<sup>2</sup>



TOTAL FLAT AREA : 58 m<sup>2</sup>

37.03 m<sup>2</sup>

12.14 m<sup>2</sup>

3.53 m<sup>2</sup>

5.63 m<sup>2</sup>

2ND FLOOR

SECTION "A"

SECTION "B"

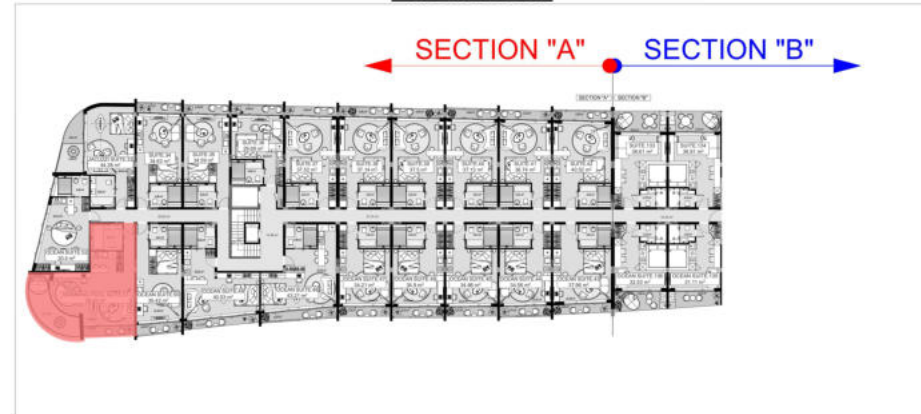

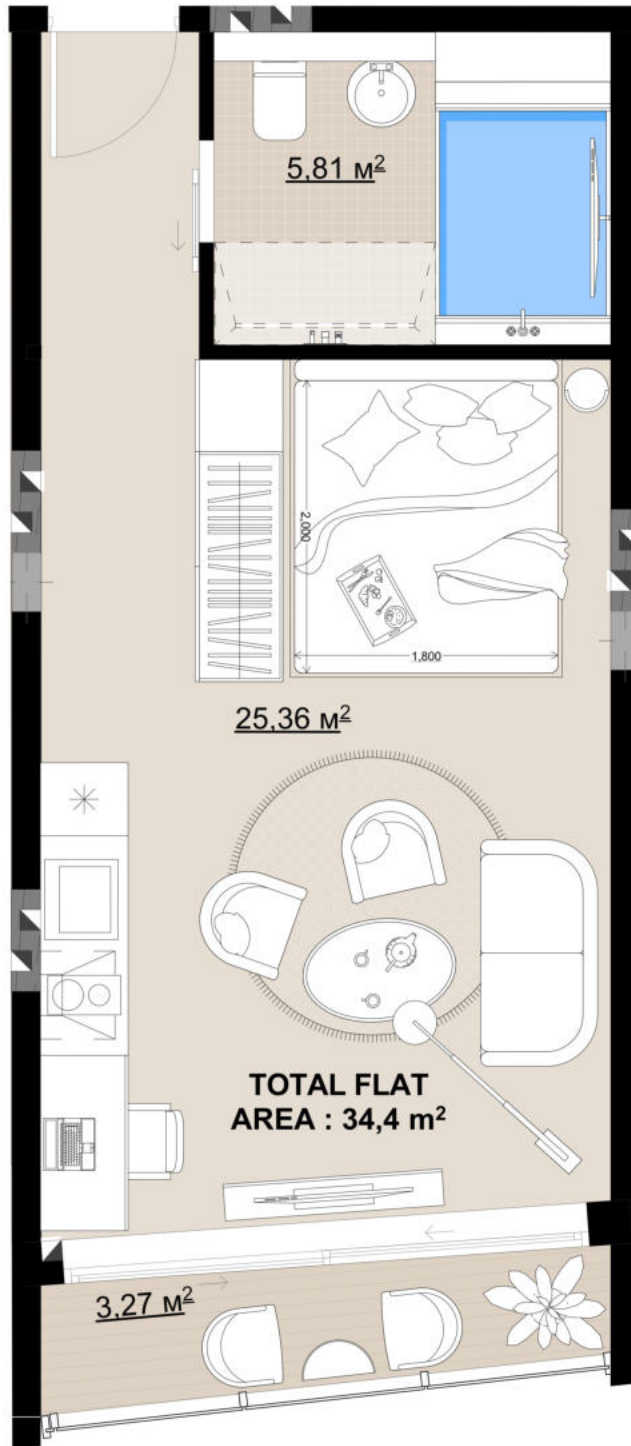

## SECTION "A"

UNIT 51

FLAT AREA : 31,17 m<sup>2</sup>

TERRACE AREA : 3.27 m<sup>2</sup>

**TOTAL FLAT AREA : 34.4 m<sup>2</sup>**



2ND FLOOR

← SECTION "A" SECTION "B" →

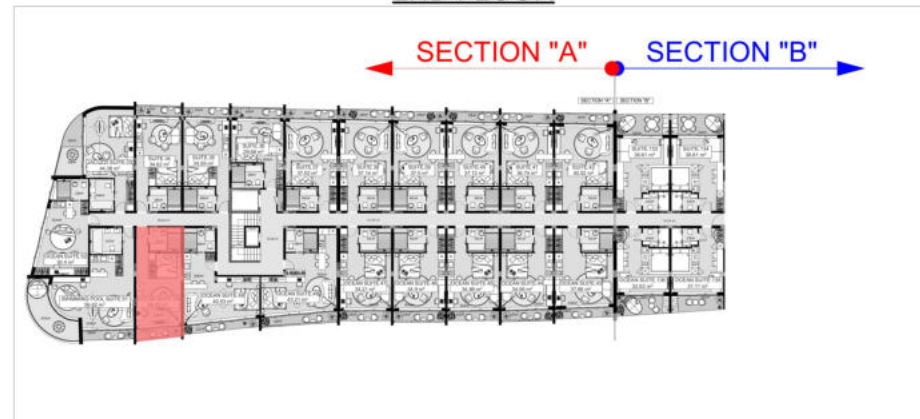

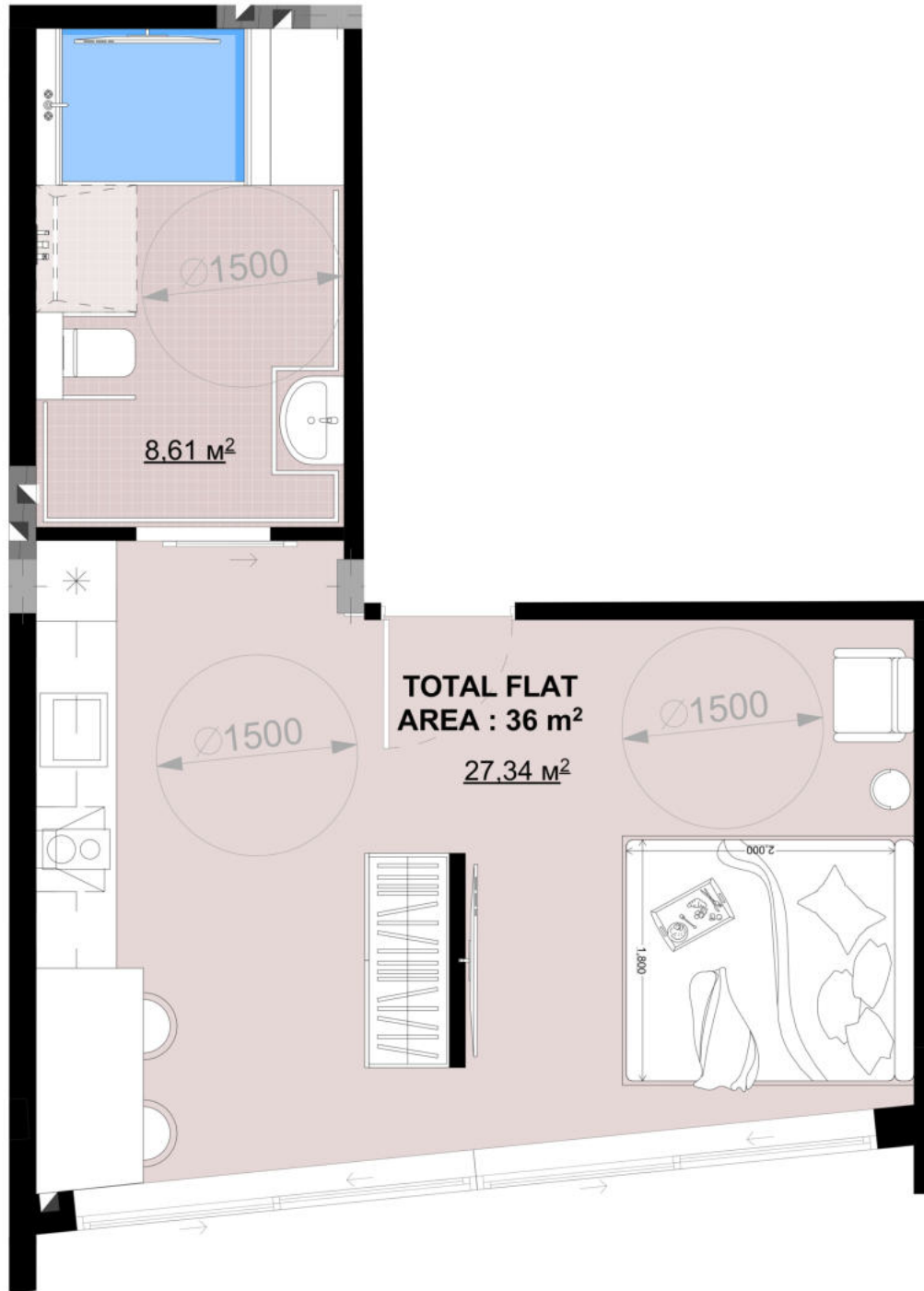

## SECTION "A"

UNIT 50

FLAT AREA : 36 m<sup>2</sup>

TERRACE AREA : 0 m<sup>2</sup>

TOTAL FLAT AREA : 36 m<sup>2</sup>



2ND FLOOR

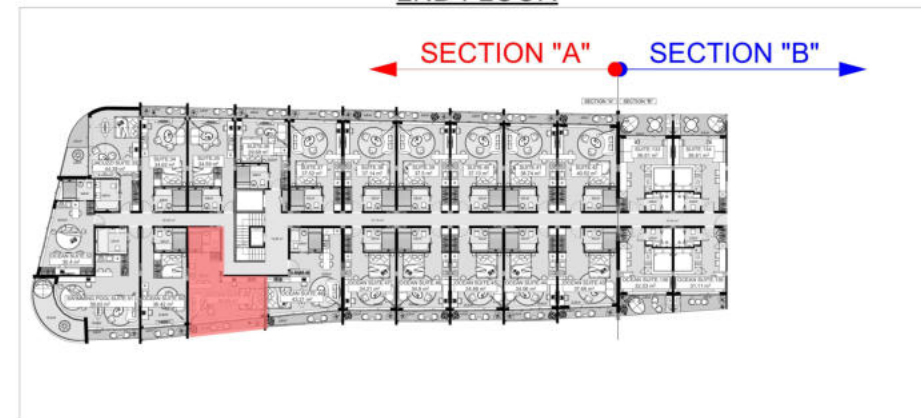

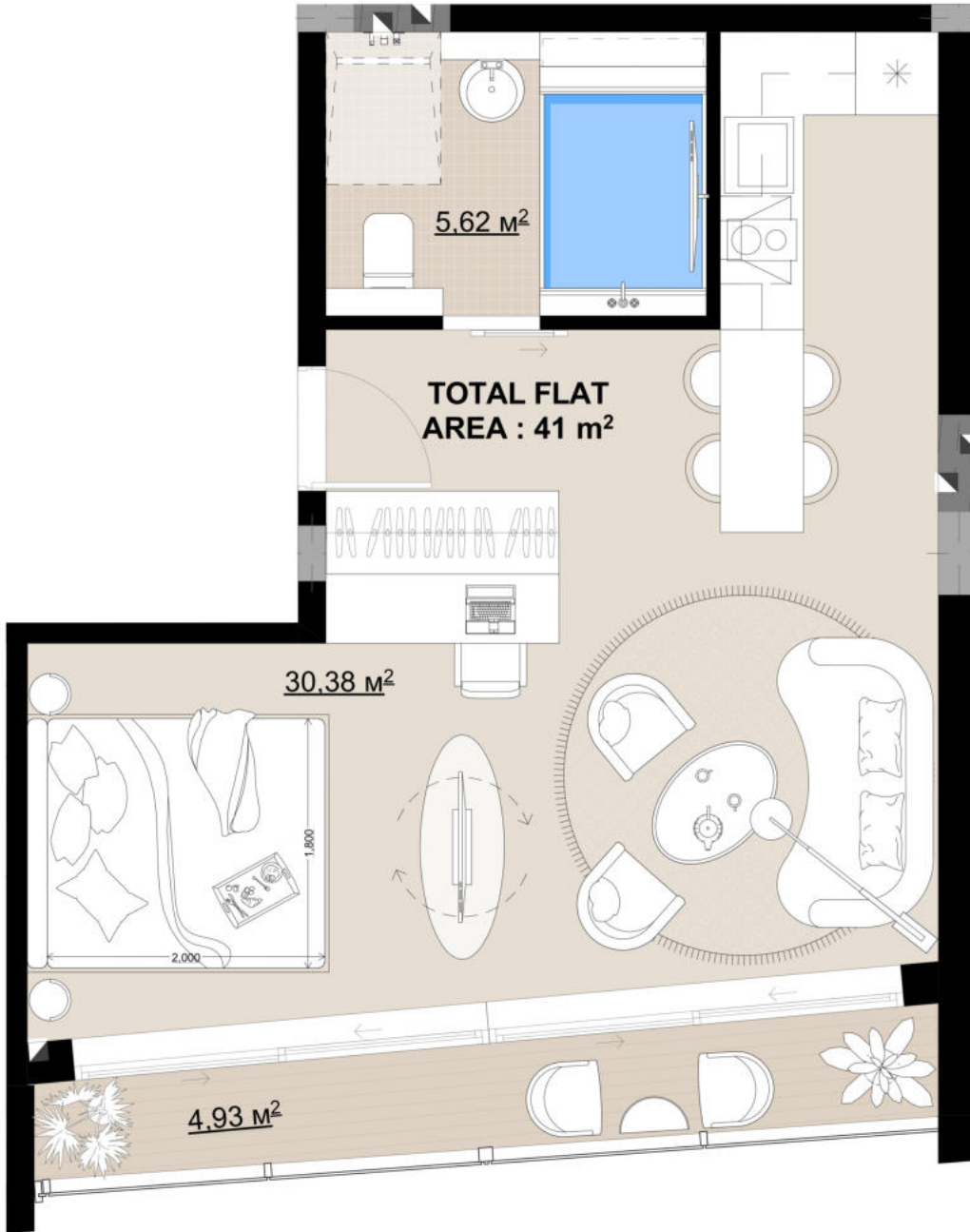

### SECTION "A"

UNIT 49

FLAT AREA : 36 m<sup>2</sup>

TERRACE AREA : 4,93 m<sup>2</sup>

TOTAL FLAT AREA : 41 m<sup>2</sup>



2ND FLOOR

SECTION "A" SECTION "B"

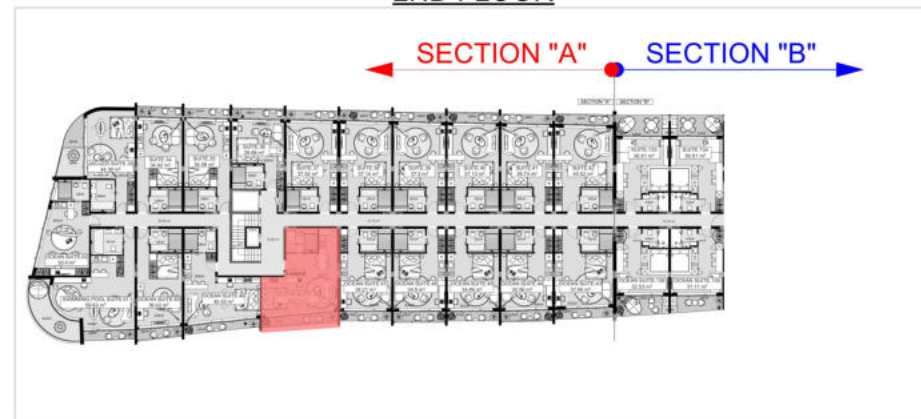

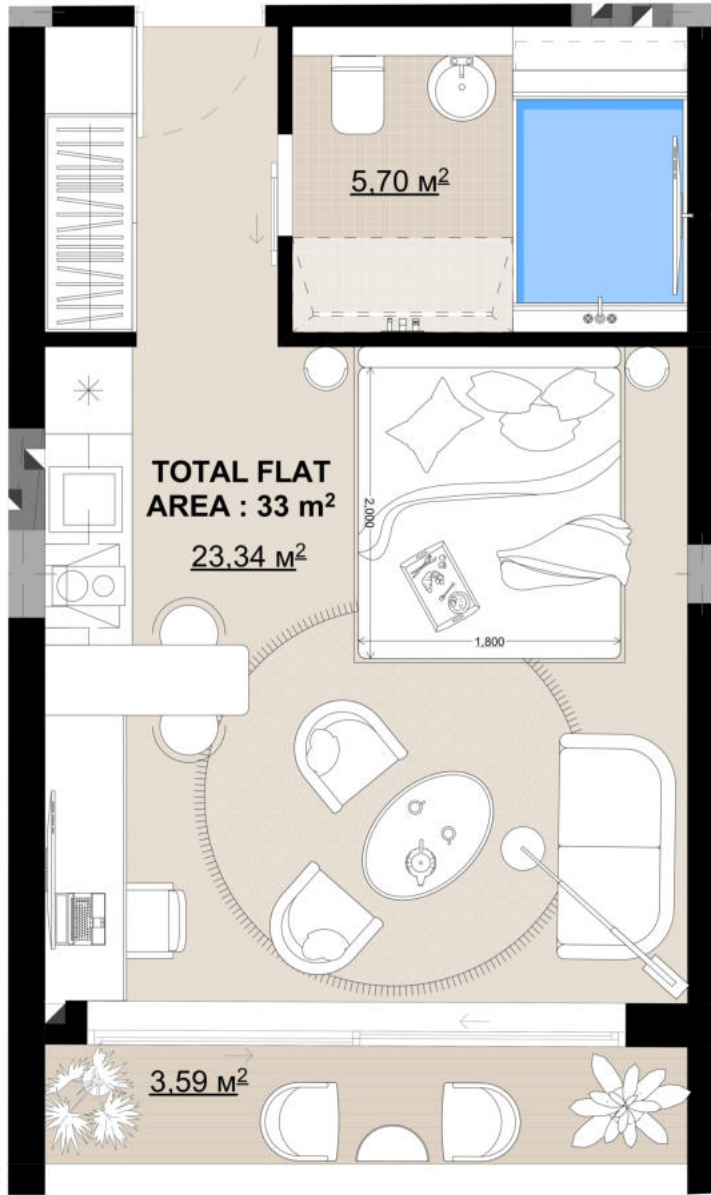

## SECTION "A"

UNIT 48

FLAT AREA : 29,04 m<sup>2</sup>

TERRACE AREA : 3,59 m<sup>2</sup>

TOTAL FLAT AREA : 33 m<sup>2</sup>



2ND FLOOR

SECTION "A" SECTION "B"

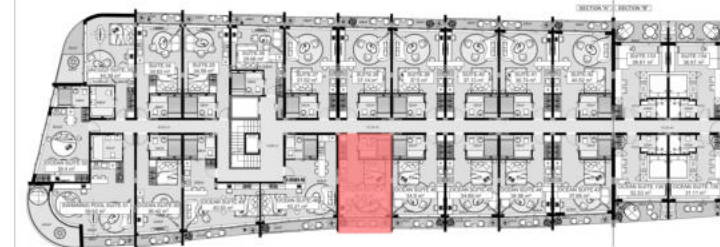

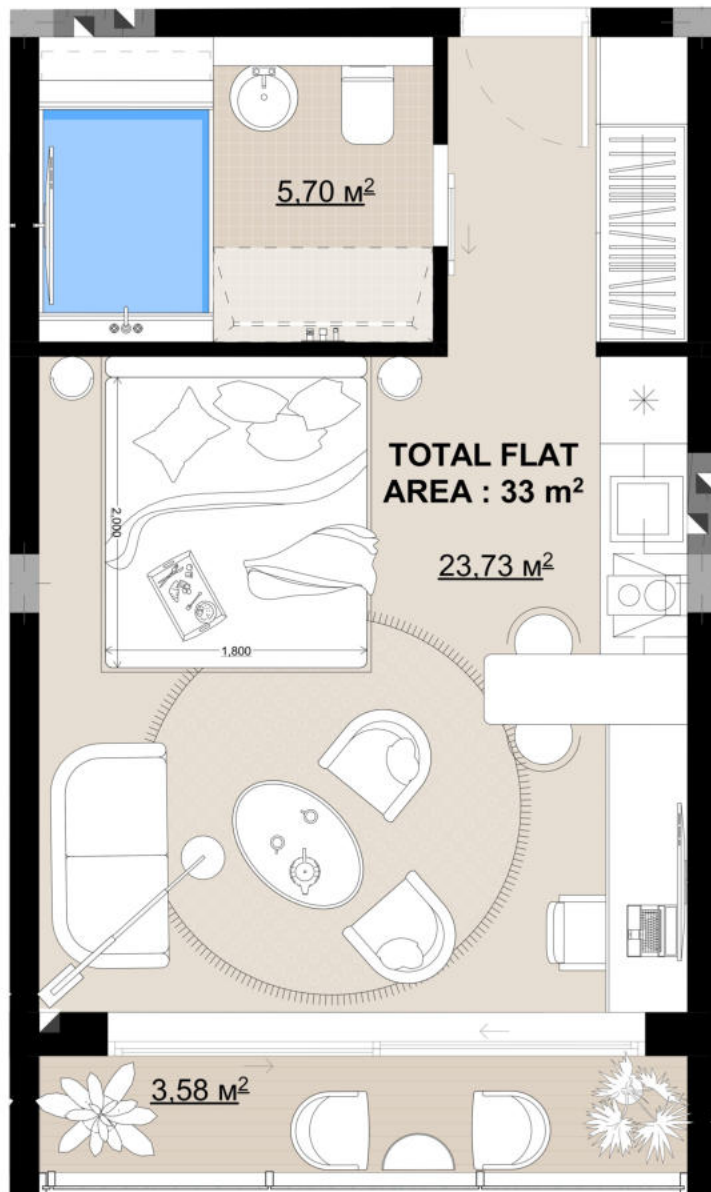

## SECTION "A"

UNIT 47

FLAT AREA : 29,43 m<sup>2</sup>

TERRACE AREA : 3,58 m<sup>2</sup>

TOTAL FLAT AREA : 33 m<sup>2</sup>



2ND FLOOR

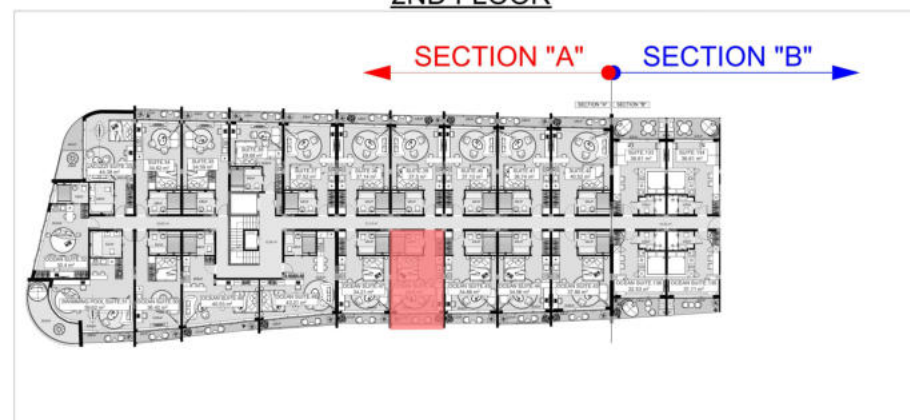

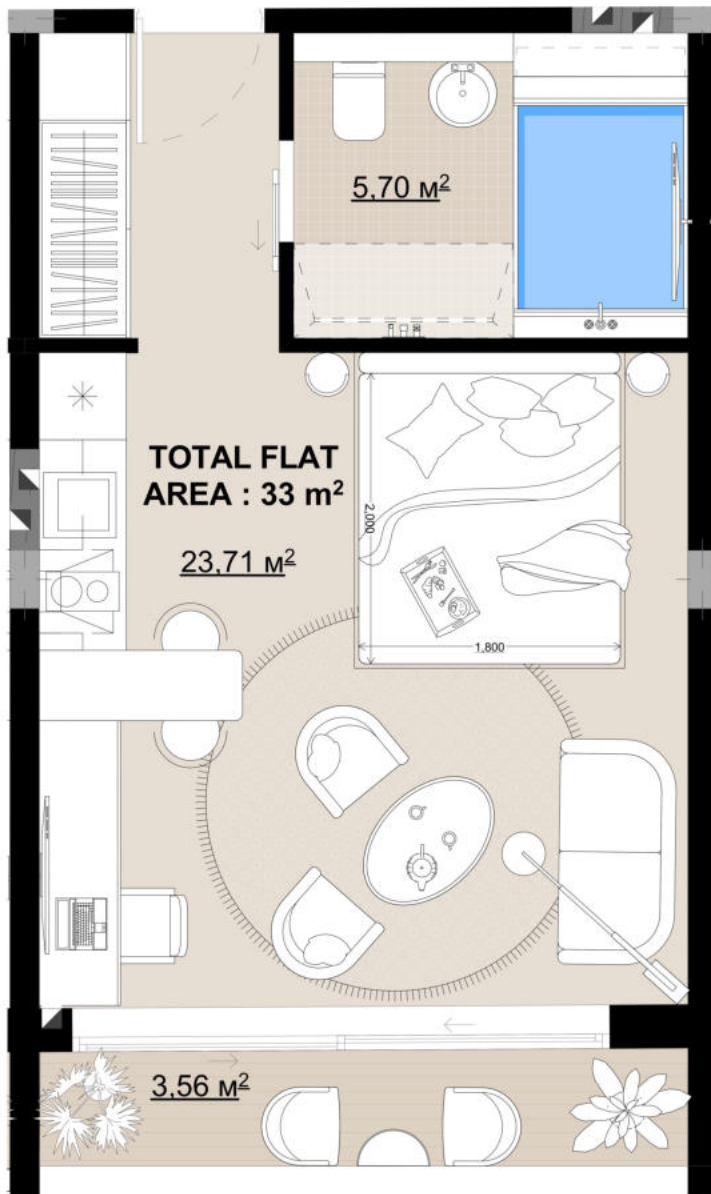

## SECTION "A"

UNIT 46

FLAT AREA : 29,41 m<sup>2</sup>

TERRACE AREA : 3,56 m<sup>2</sup>

TOTAL FLAT AREA : 33 m<sup>2</sup>



2ND FLOOR

SECTION "A" SECTION "B"



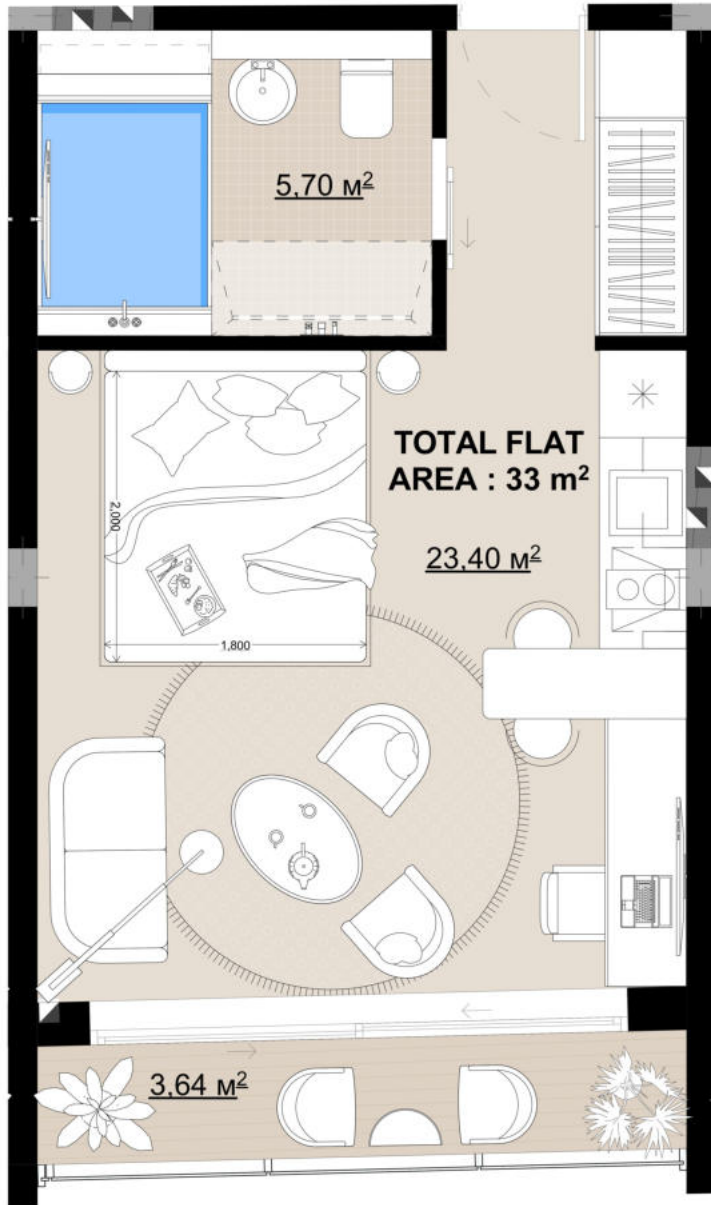

## SECTION "A"

UNIT 45

FLAT AREA : 29,1 m<sup>2</sup>

TERRACE AREA : 3,64 m<sup>2</sup>

TOTAL FLAT AREA : 33 m<sup>2</sup>



2ND FLOOR

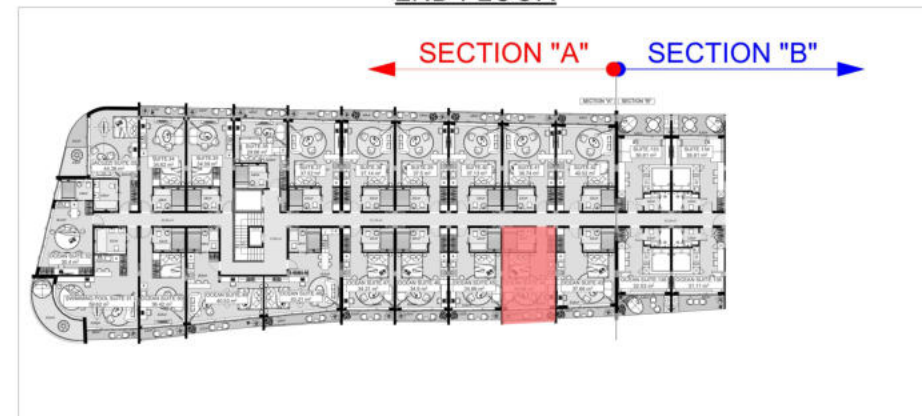

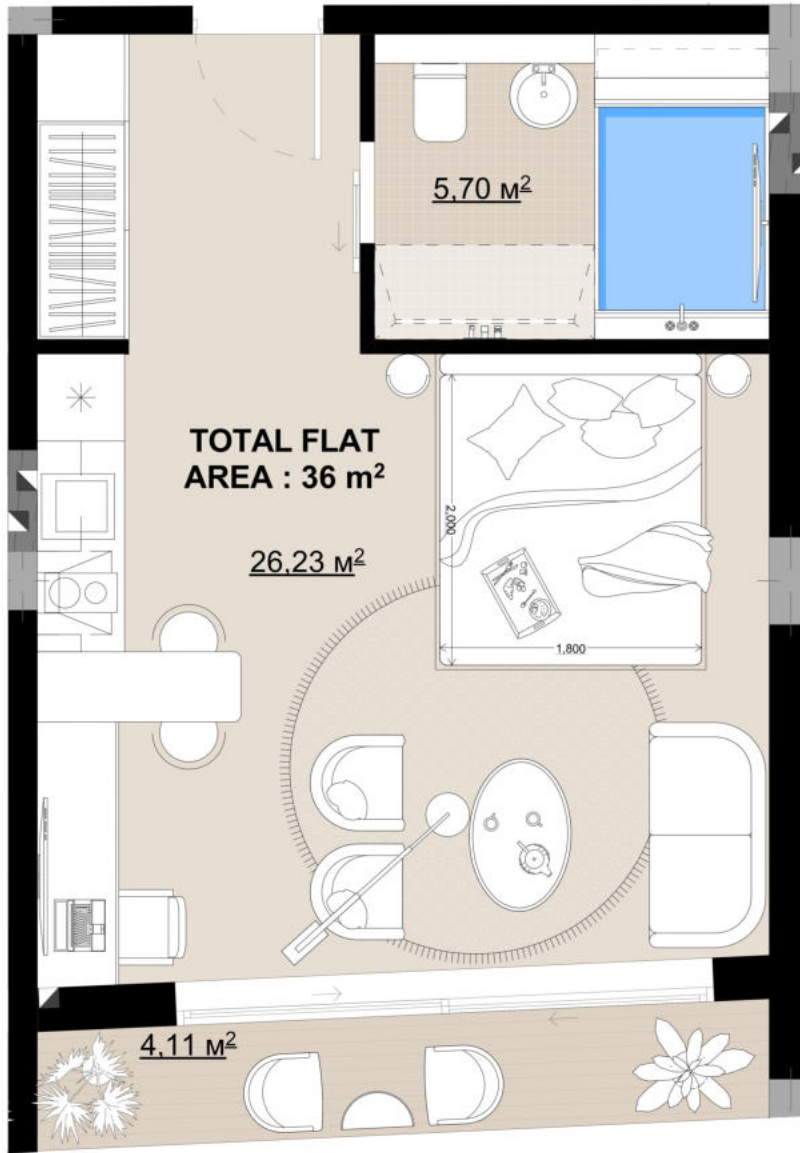

## SECTION "A"

UNIT 44

FLAT AREA : 31.93 m<sup>2</sup>

TERRACE AREA : 4,11 m<sup>2</sup>

TOTAL FLAT AREA : 36 m<sup>2</sup>



2ND FLOOR

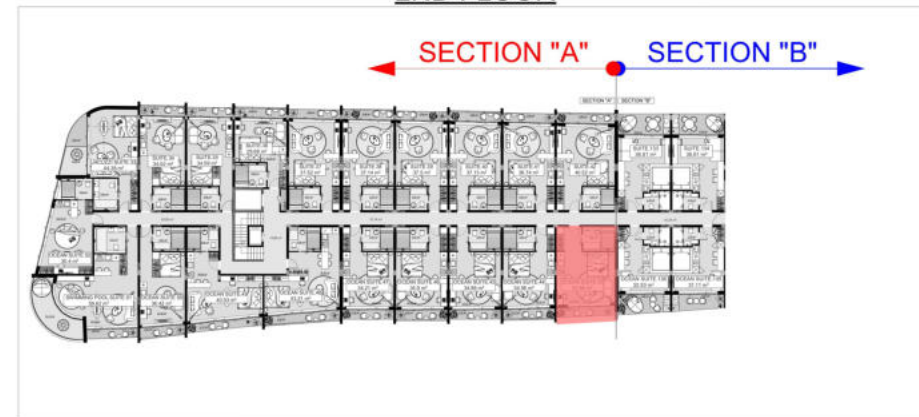

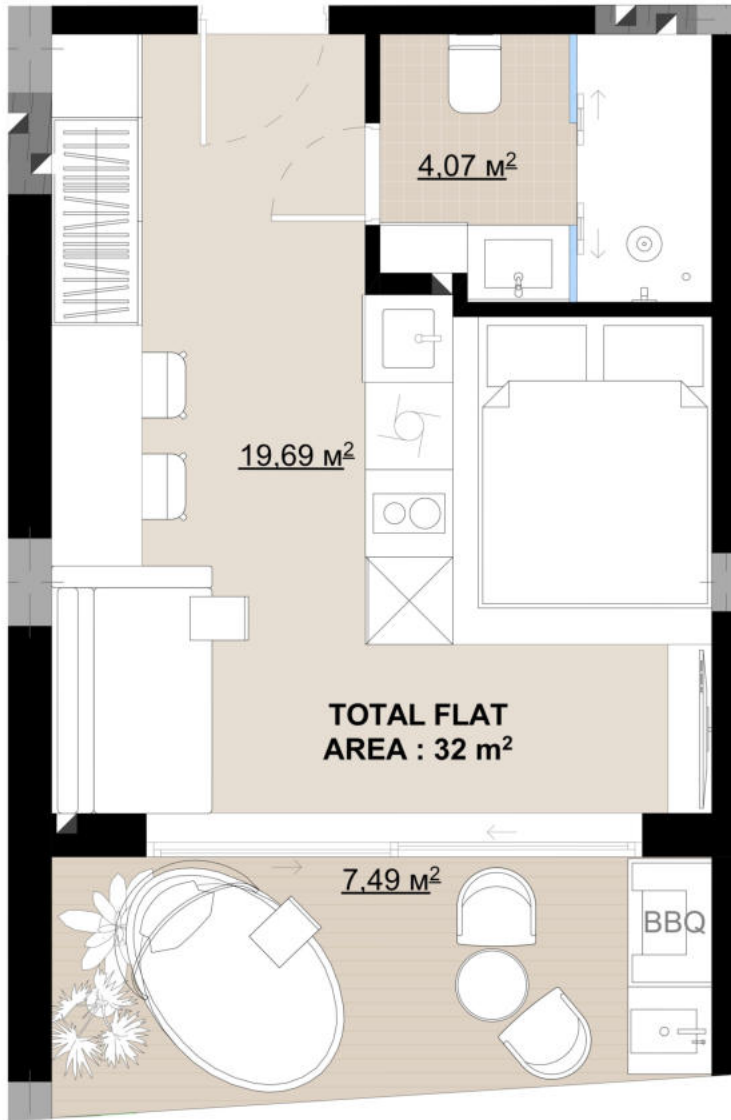

## SECTION "B"

UNIT 43

FLAT AREA : 23,68 m<sup>2</sup>

TERRACE AREA : 7,49 m<sup>2</sup>

TOTAL FLAT AREA : 32 m<sup>2</sup>



2ND FLOOR

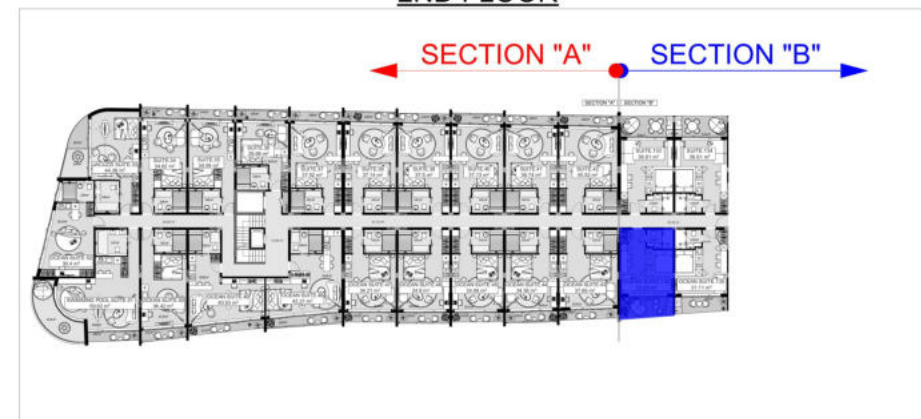

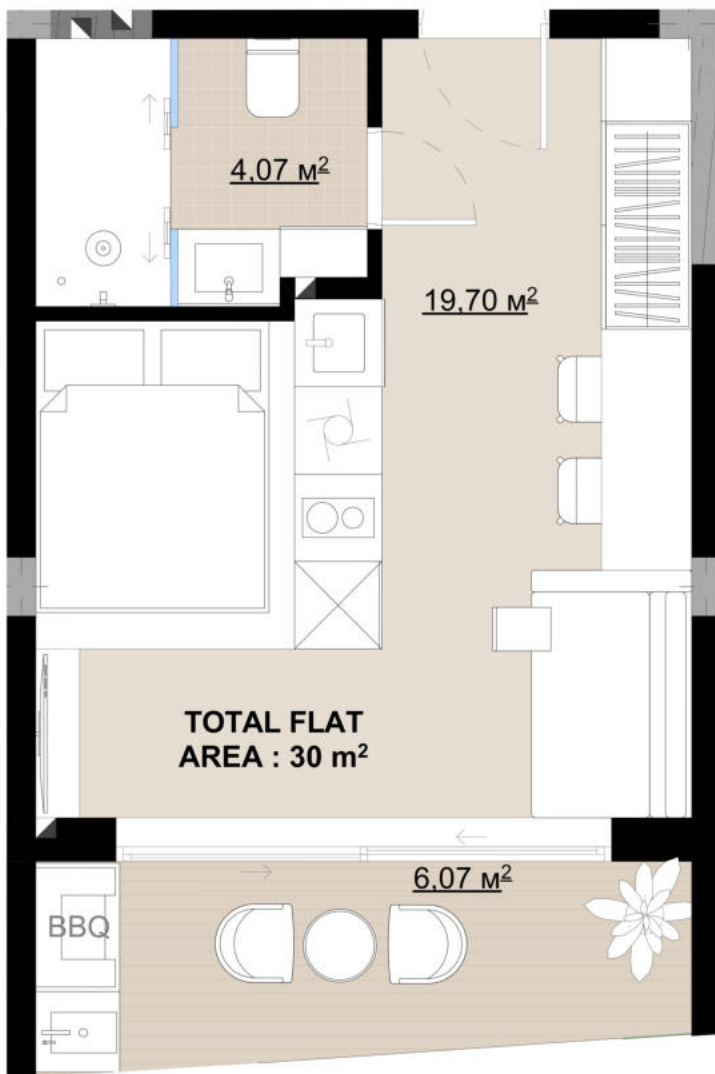

## SECTION "B"

UNIT 42

FLAT AREA : 23,5 m<sup>2</sup>

TERRACE AREA : 6,07 m<sup>2</sup>

TOTAL FLAT AREA : 30 m<sup>2</sup>



2ND FLOOR

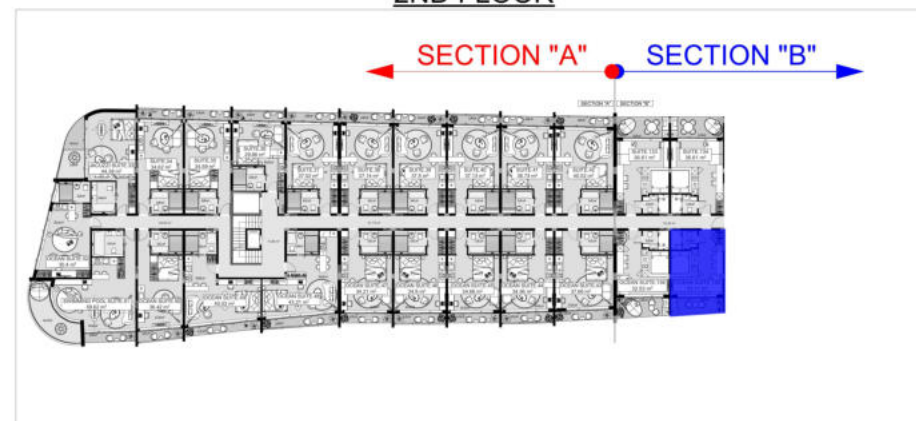

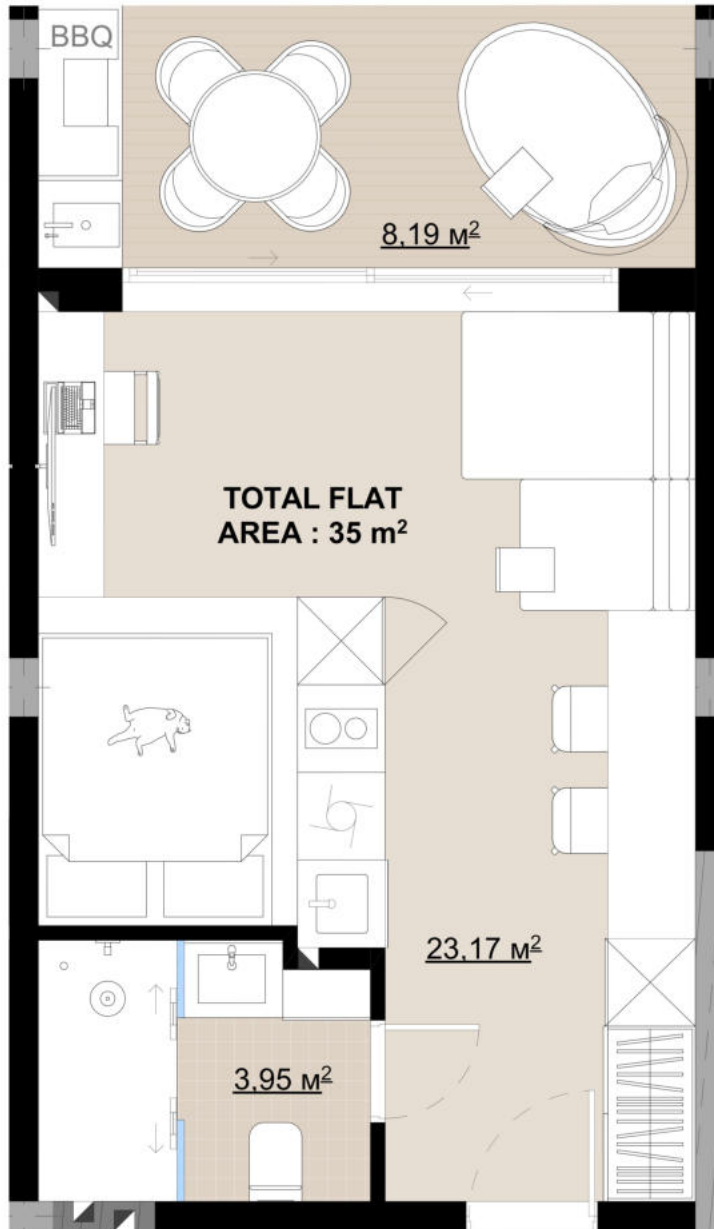

## SECTION "B"

UNIT 41

FLAT AREA : 27,12 m<sup>2</sup>

TERRACE AREA : 8,19 m<sup>2</sup>

TOTAL FLAT AREA : 35 m<sup>2</sup>



2ND FLOOR

SECTION "A" SECTION "B"

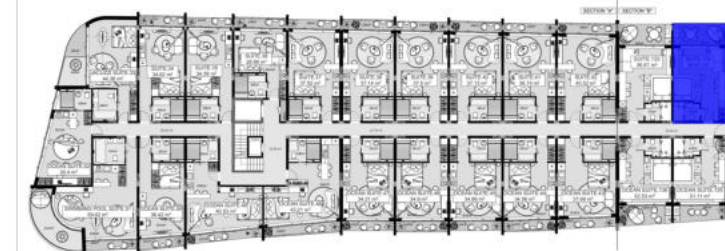



## SECTION "B"

UNIT 40

FLAT AREA : 27,12 m<sup>2</sup>

TERRACE AREA : 8,19 m<sup>2</sup>

TOTAL FLAT AREA : 35 m<sup>2</sup>

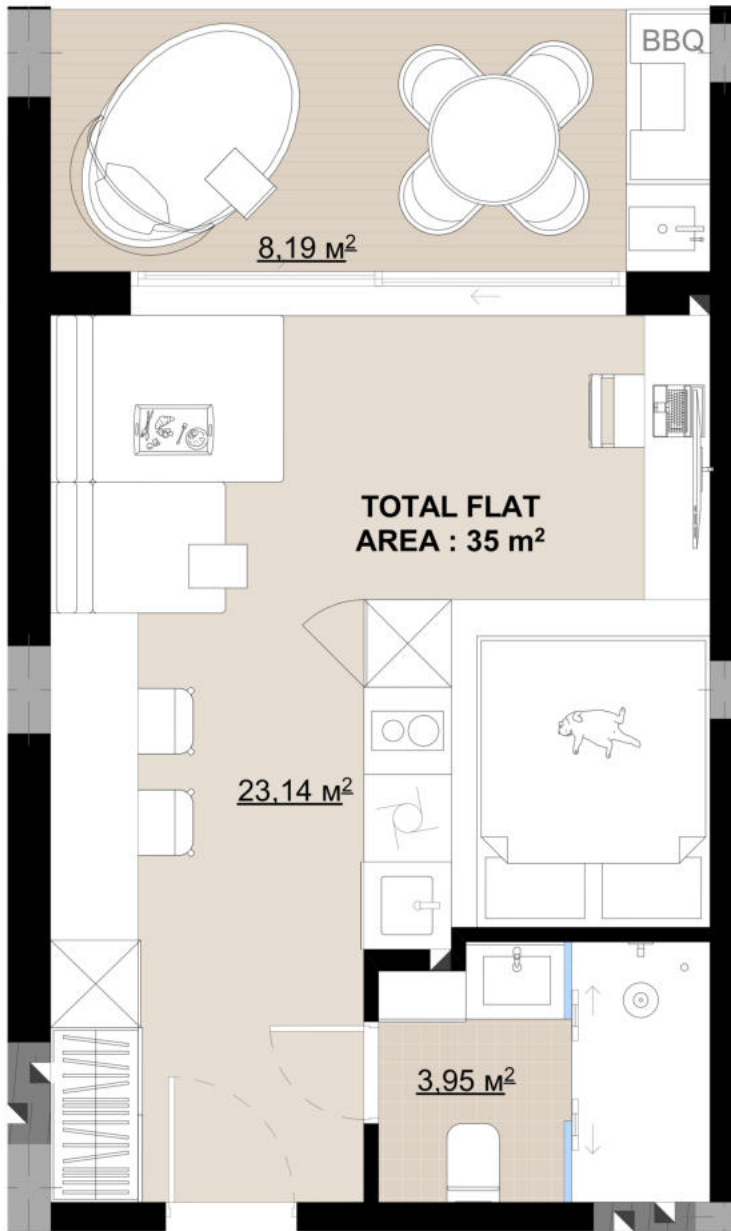

2ND FLOOR

SECTION "A" SECTION "B"

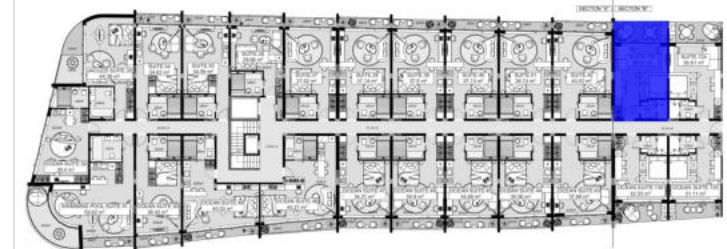

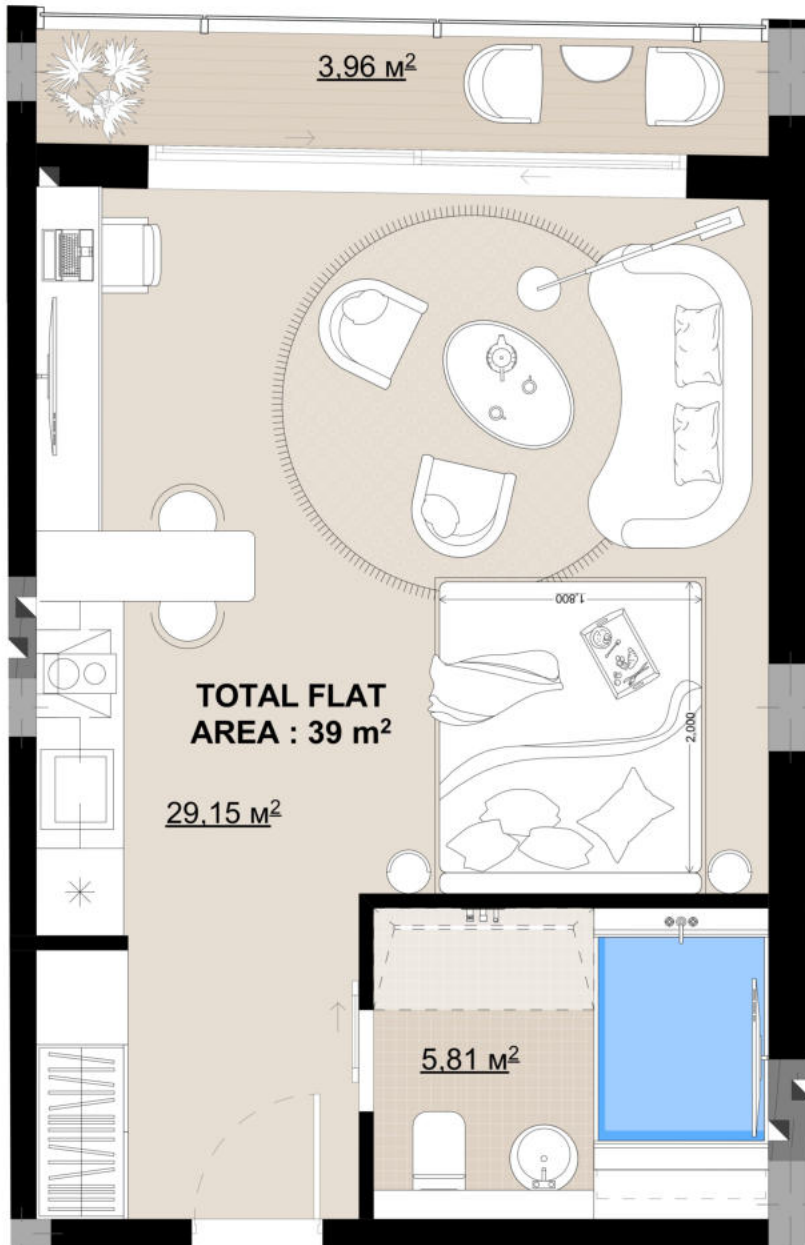

## SECTION "A"

UNIT 39

FLAT AREA : 34,96 m<sup>2</sup>

TERRACE AREA : 3.96 m<sup>2</sup>

TOTAL FLAT AREA : 39 m<sup>2</sup>



2ND FLOOR

SECTION "A" SECTION "B"

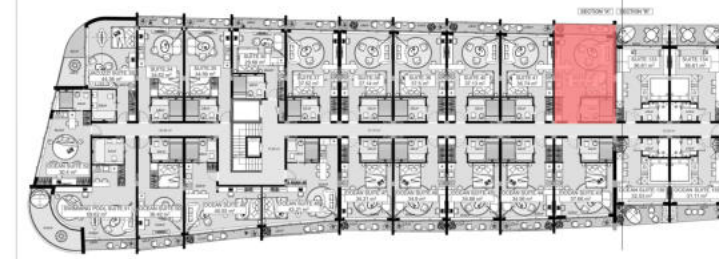

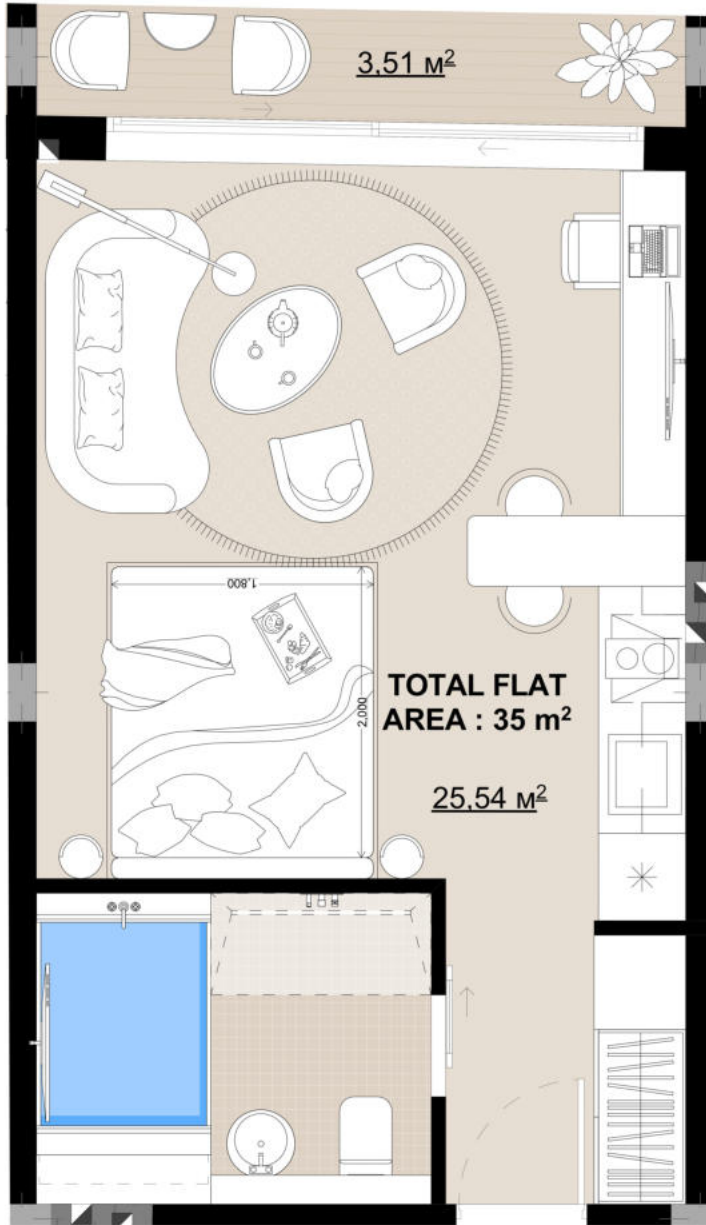

## SECTION "A"

UNIT 38

FLAT AREA : 31.35 m<sup>2</sup>

TERRACE AREA : 3.51 m<sup>2</sup>

TOTAL FLAT AREA : 35 m<sup>2</sup>



2ND FLOOR

SECTION "A" SECTION "B"

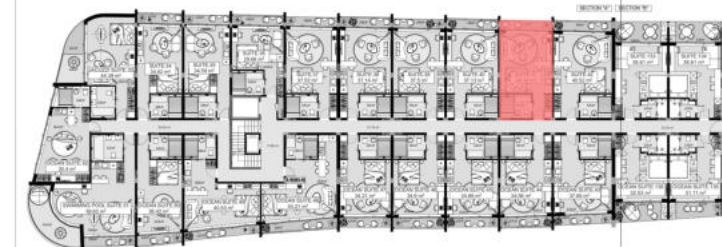

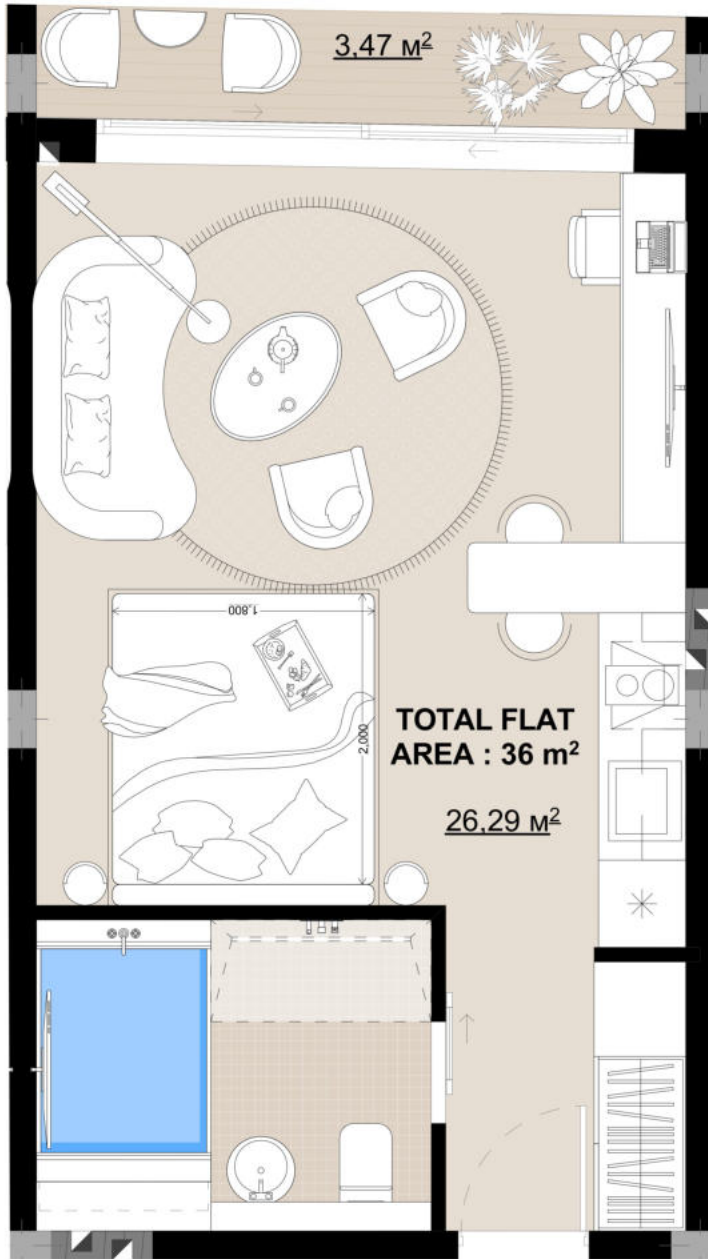

## SECTION "A"

UNIT 37

FLAT AREA : 32,1 m<sup>2</sup>

TERRACE AREA : 3,47 m<sup>2</sup>

TOTAL FLAT AREA : 36 m<sup>2</sup>



2ND FLOOR

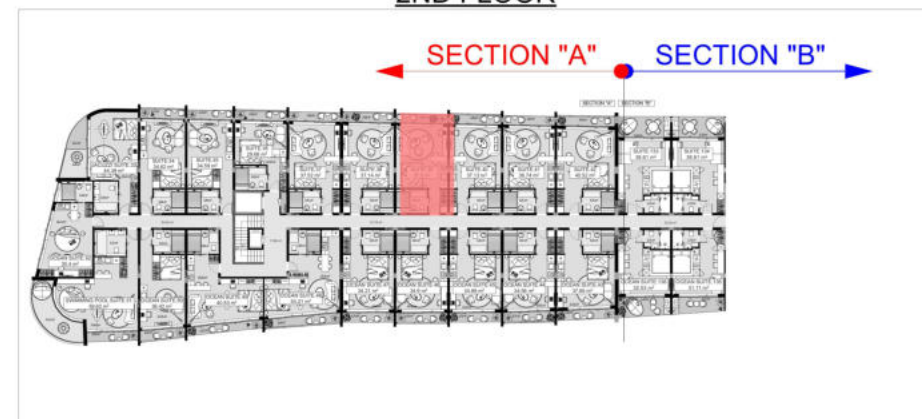

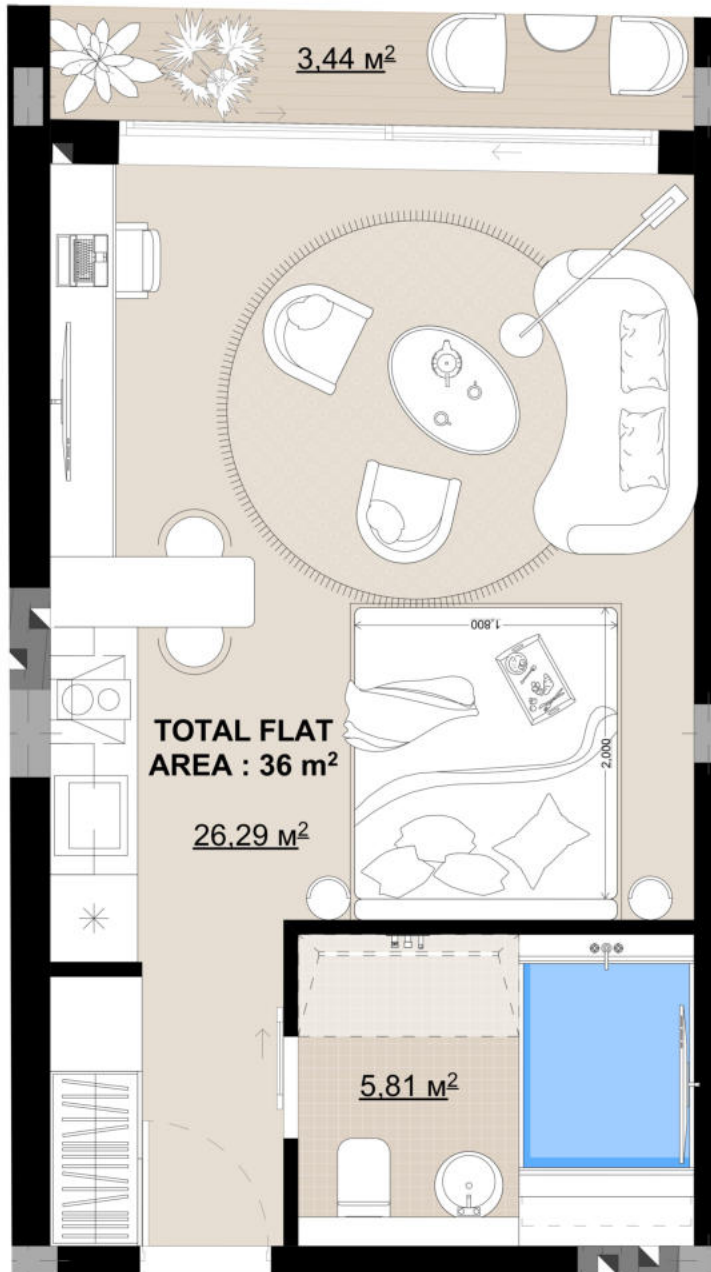

## SECTION "A"

UNIT 36

FLAT AREA : 32,1 m<sup>2</sup>

TERRACE AREA : 3,44 m<sup>2</sup>

TOTAL FLAT AREA : 36 m<sup>2</sup>



2ND FLOOR

SECTION "A"

SECTION "B"

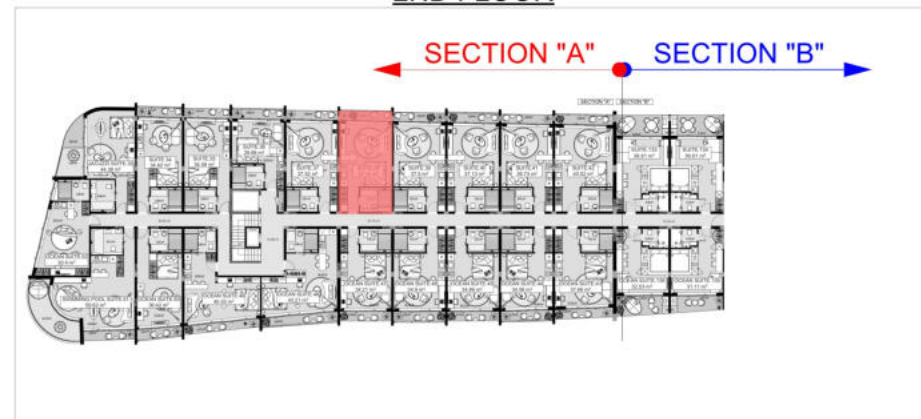

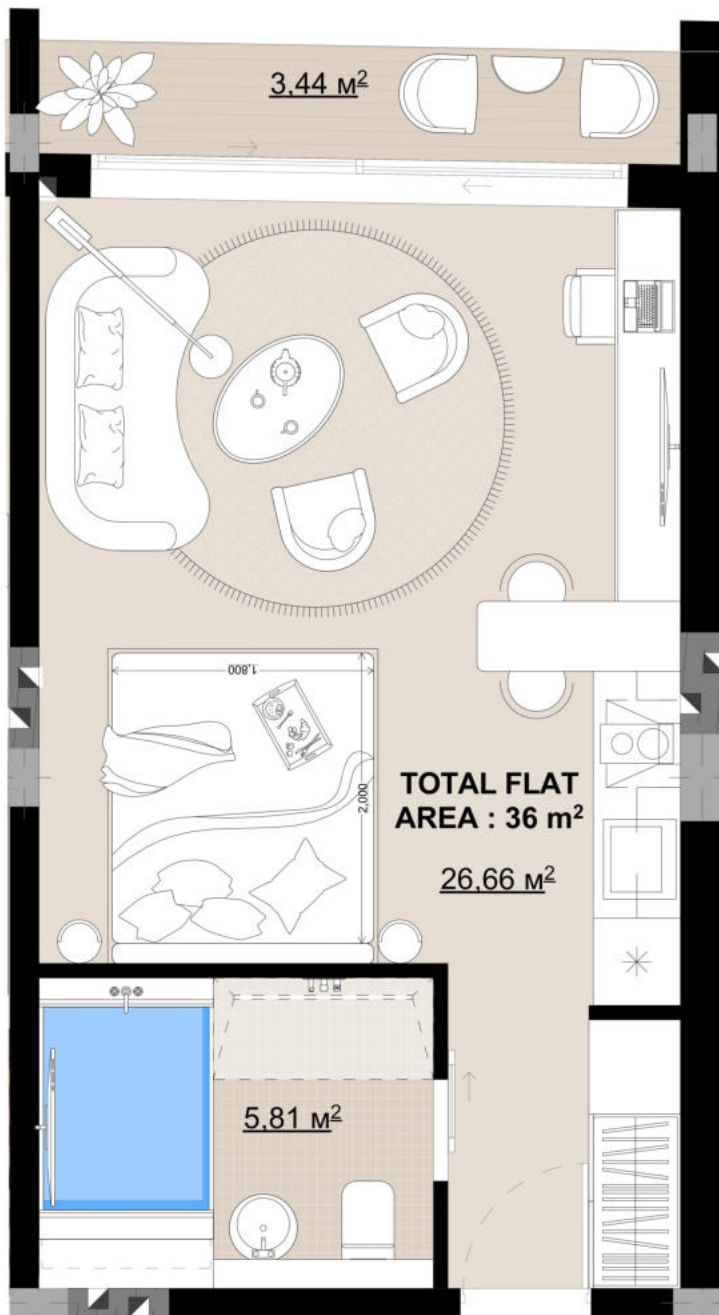

## SECTION "A"

UNIT 35

FLAT AREA : 32,47 m<sup>2</sup>

TERRACE AREA : 3,44 m<sup>2</sup>

TOTAL FLAT AREA : 36 m<sup>2</sup>



2ND FLOOR

SECTION "A" SECTION "B"



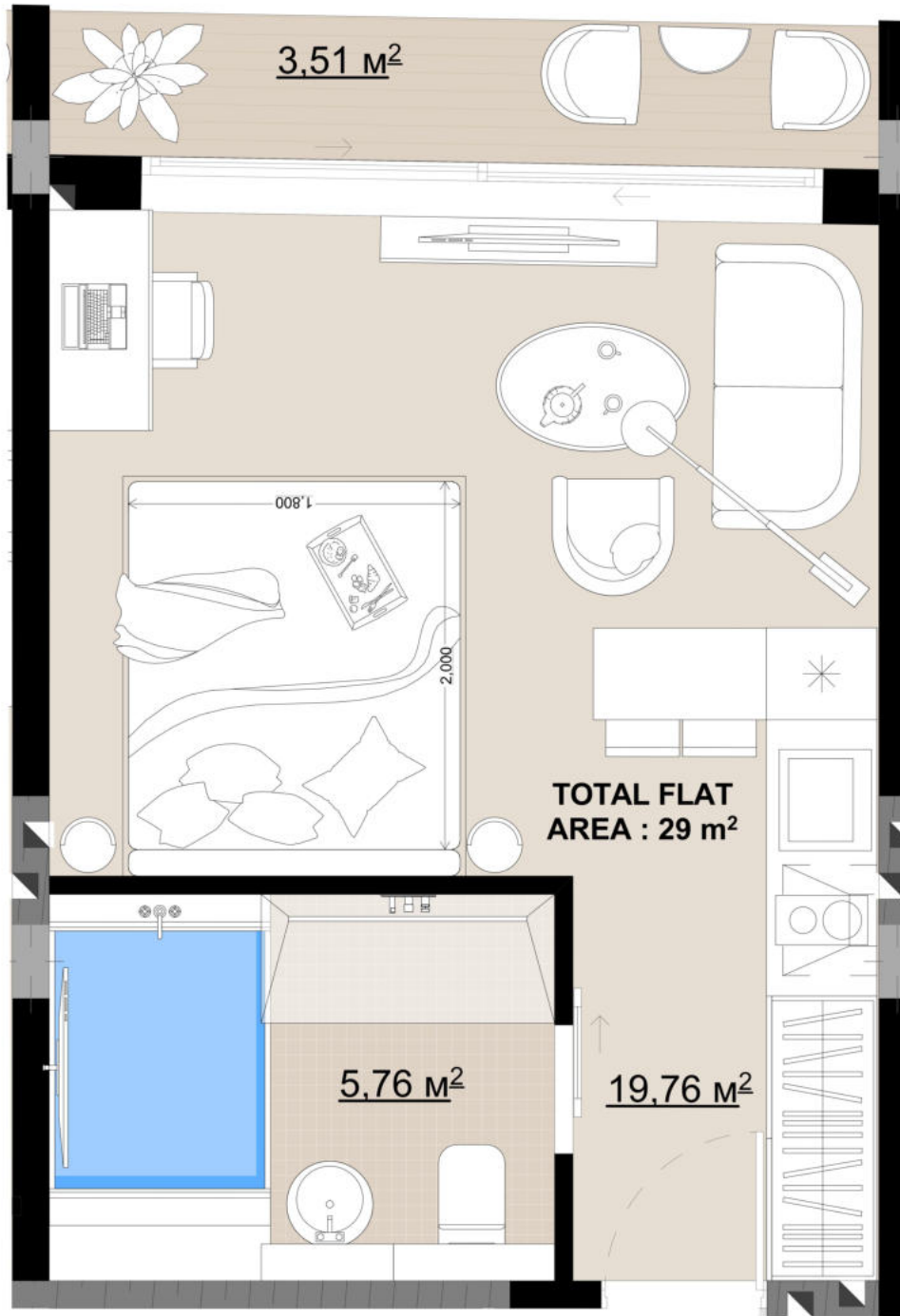

## SECTION "A"

UNIT 34

FLAT AREA : 25.52 m<sup>2</sup>

TERRACE AREA : 3.51 m<sup>2</sup>

TOTAL FLAT AREA : 29 m<sup>2</sup>



2ND FLOOR

← SECTION "A" SECTION "B" →

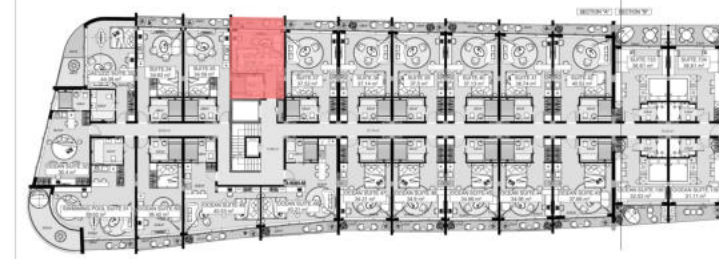

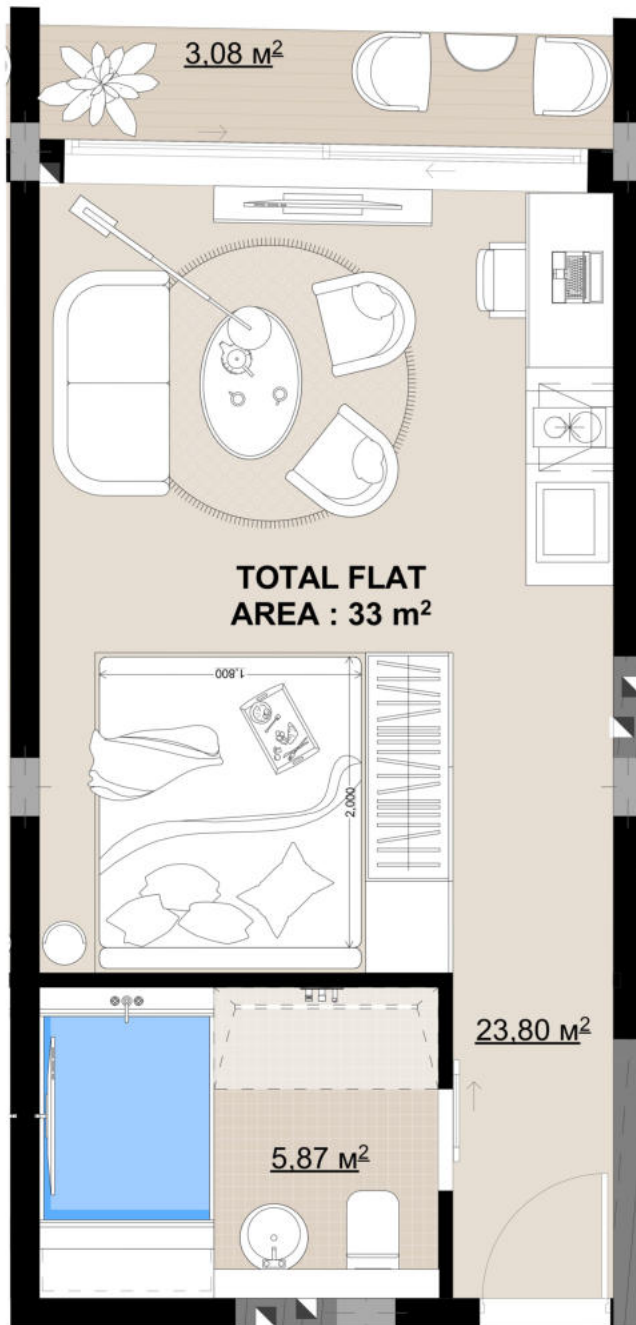

## SECTION "A"

UNIT 33

FLAT AREA : 29,67 m<sup>2</sup>

TERRACE AREA : 3,08 m<sup>2</sup>

TOTAL FLAT AREA : 33 m<sup>2</sup>



2ND FLOOR

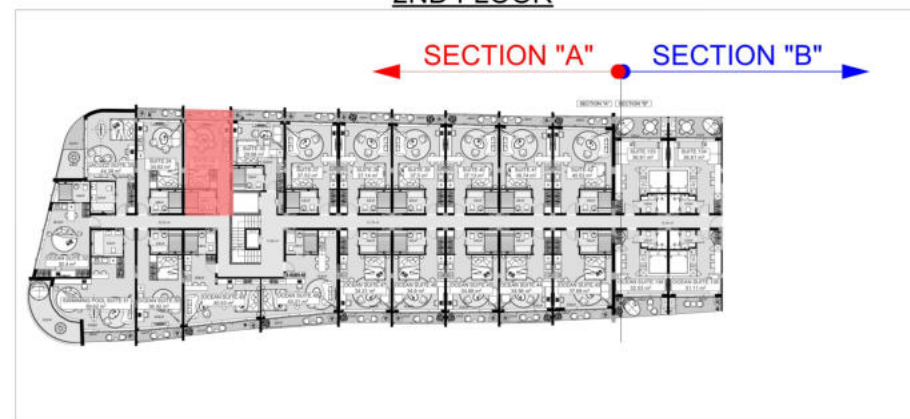

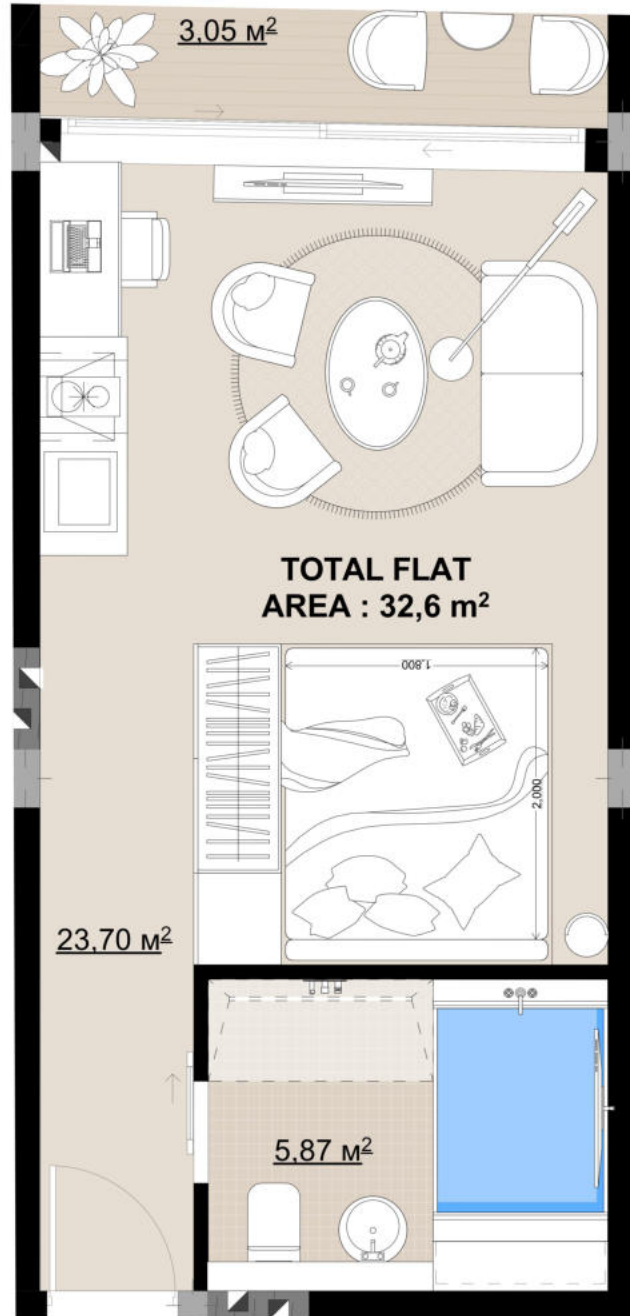

## SECTION "A"

UNIT 32

FLAT AREA : 29,57 m<sup>2</sup>

TERRACE AREA : 3.05 m<sup>2</sup>

TOTAL FLAT AREA : 32.6 m<sup>2</sup>



2ND FLOOR

← SECTION "A" SECTION "B" →

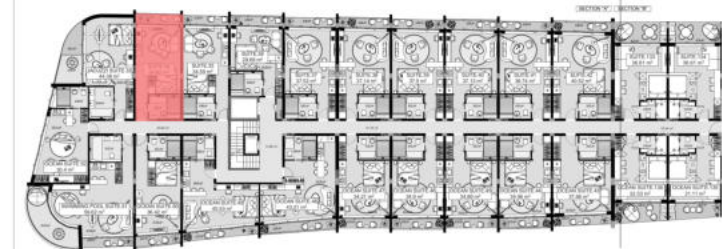

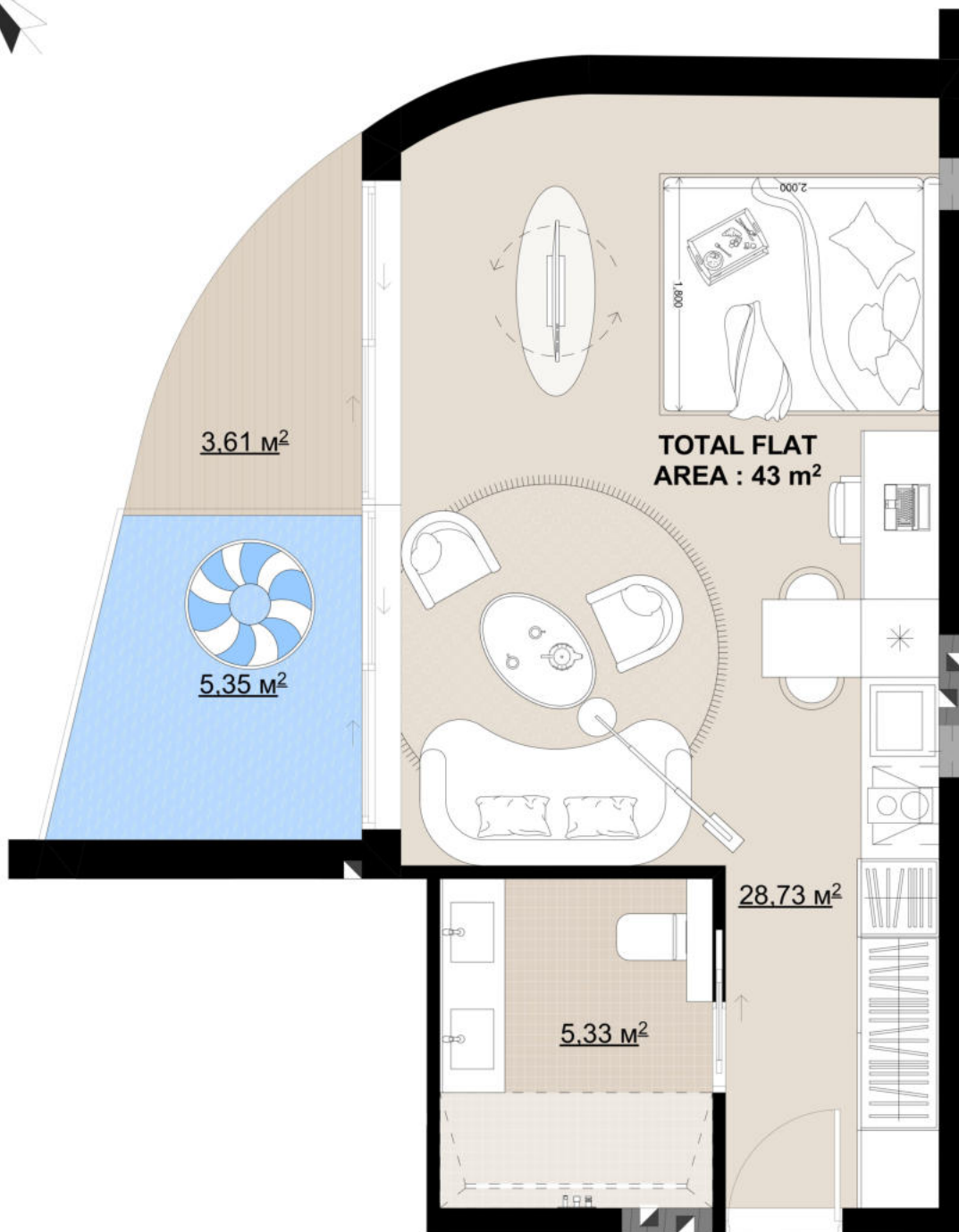

### SECTION "A"

UNIT 31

FLAT AREA : 34 m<sup>2</sup>

TERRACE AREA : 8,96 m<sup>2</sup>

TOTAL FLAT AREA : 43 m<sup>2</sup>



2ND FLOOR

SECTION "A" SECTION "B"

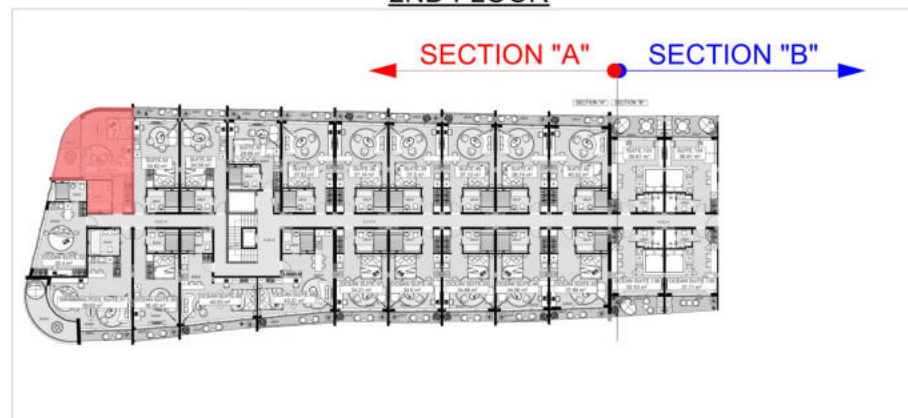

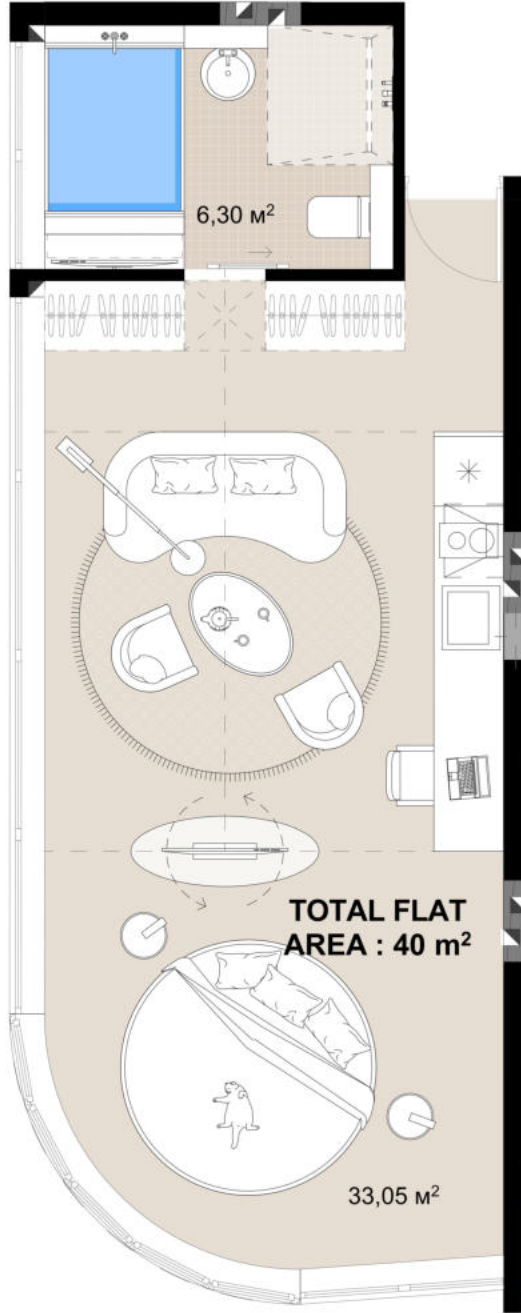

## SECTION "A"

UNIT 30

FLAT AREA : 40 m<sup>2</sup>

TERRACE AREA : 0 m<sup>2</sup>

TOTAL FLAT AREA : 40 m<sup>2</sup>



1ST FLOOR

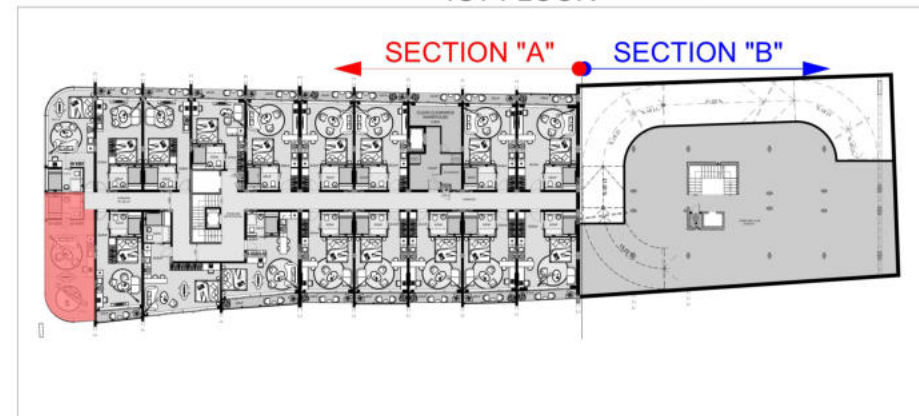

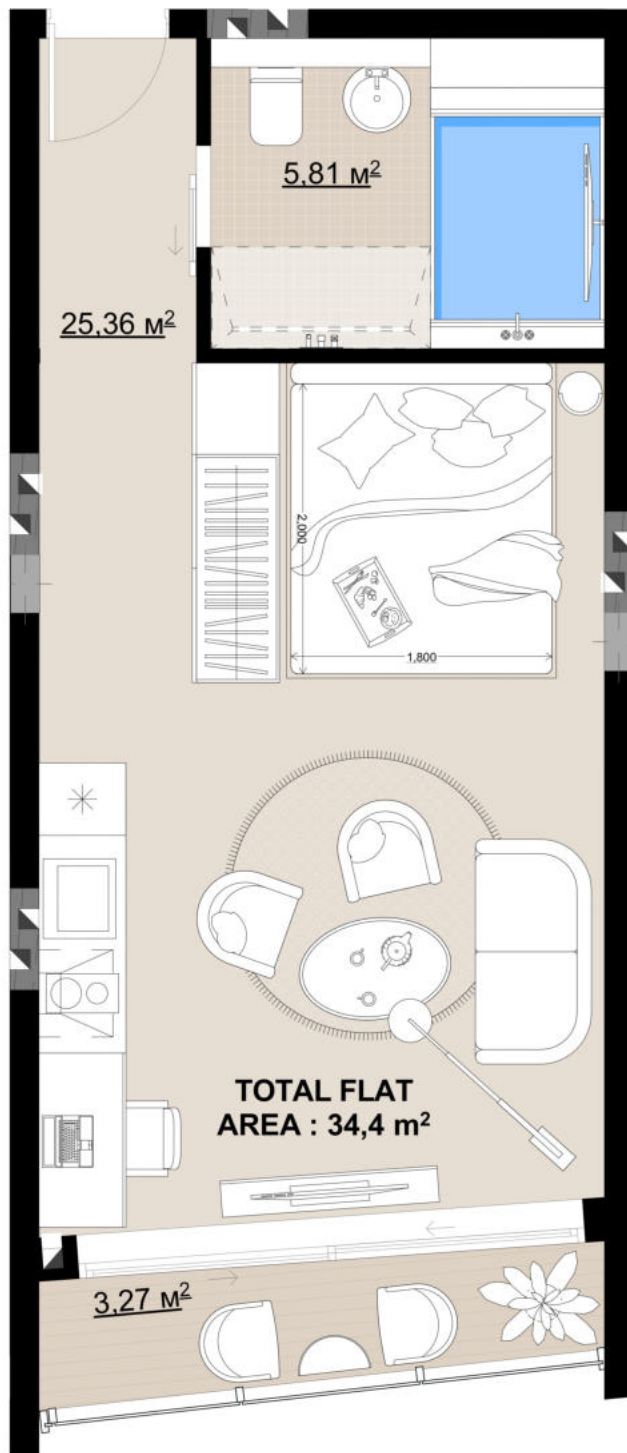

## SECTION "A"

UNIT 29

FLAT AREA : 31,17 m<sup>2</sup>

TERRACE AREA : 3.27 m<sup>2</sup>

TOTAL FLAT AREA : 34.4 m<sup>2</sup>



1ST FLOOR

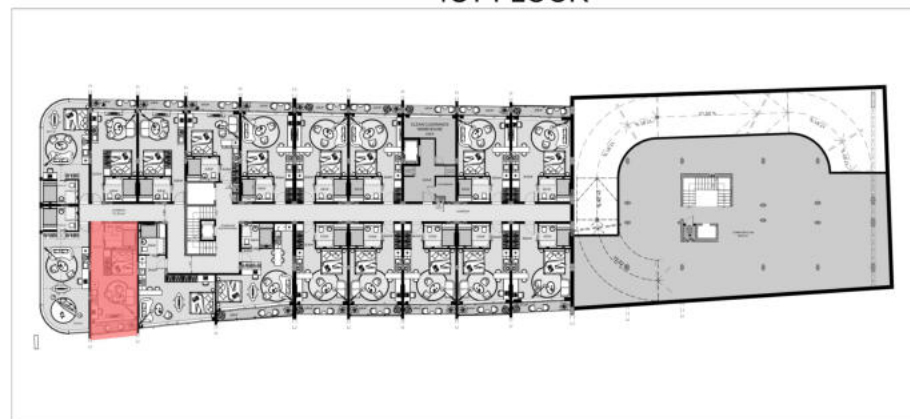

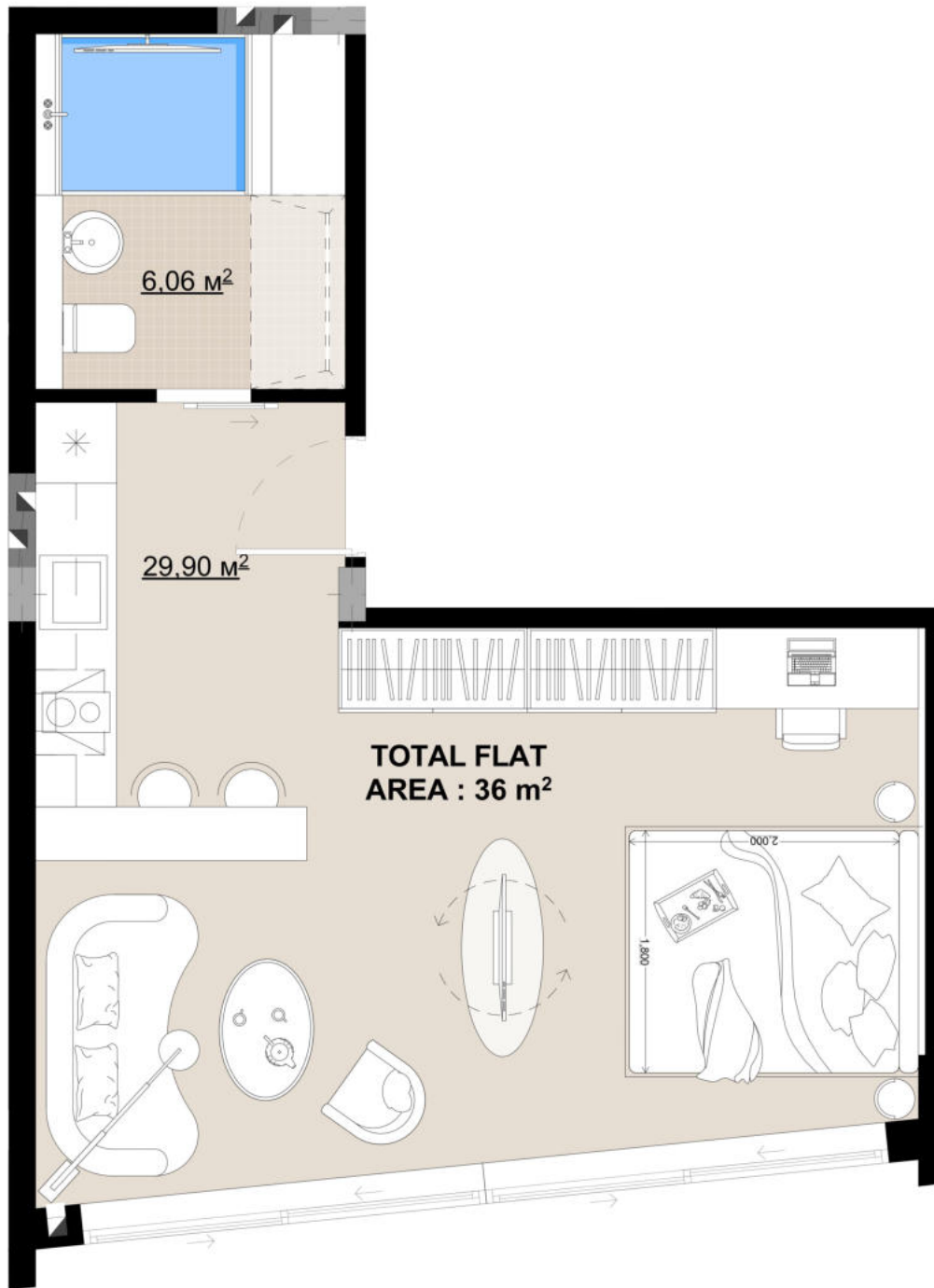

## SECTION "A"

UNIT 28

FLAT AREA : 36 m<sup>2</sup>

TERRACE AREA : 0 m<sup>2</sup>

TOTAL FLAT AREA : 36 m<sup>2</sup>



1ST FLOOR

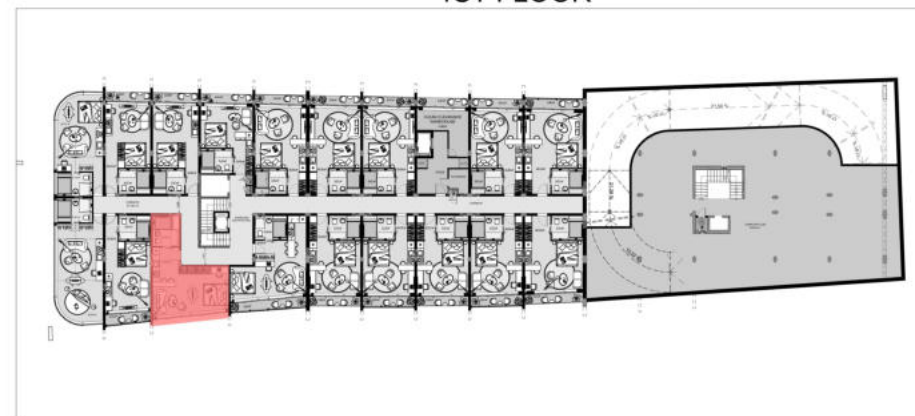

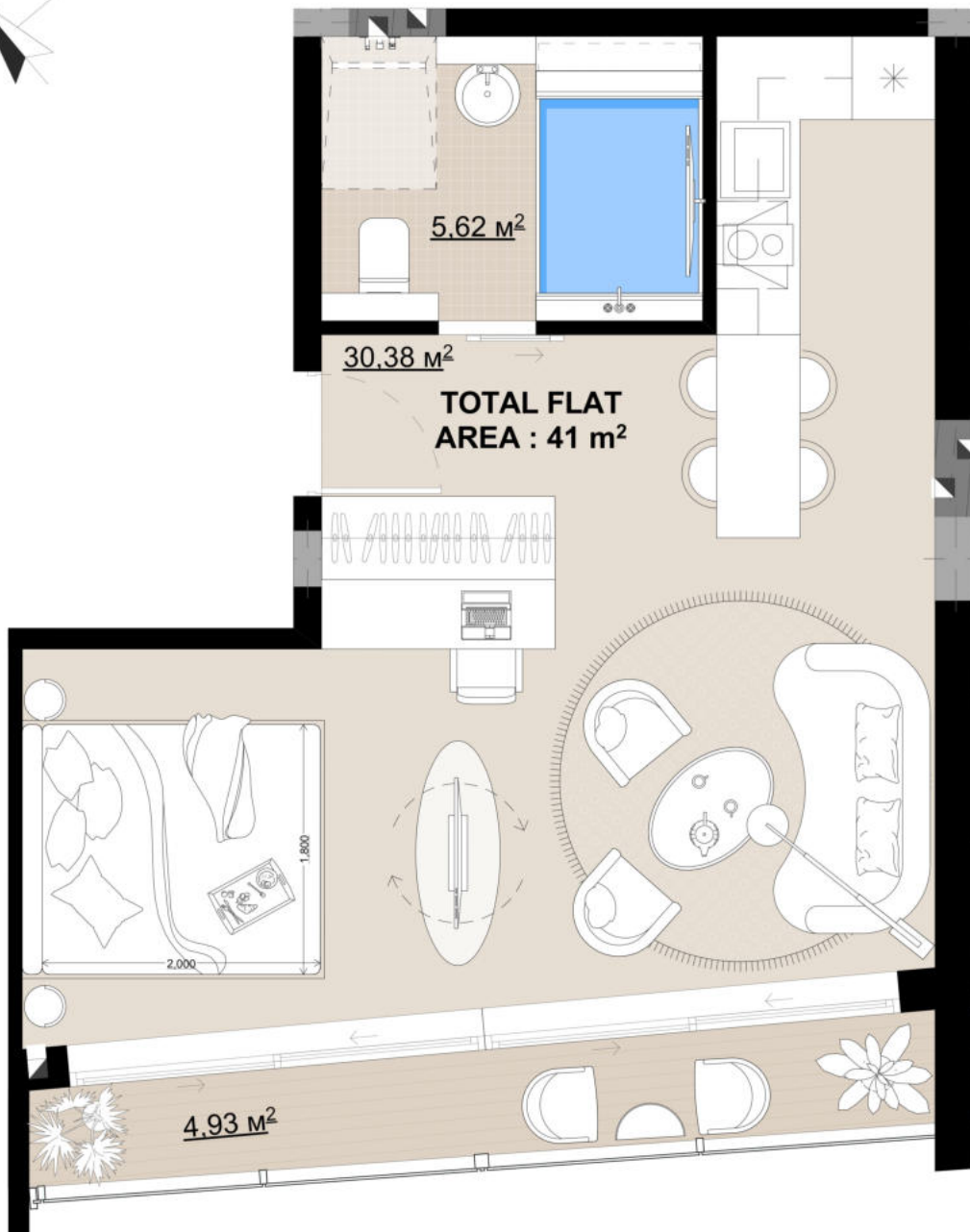

## SECTION "A"

UNIT 27

FLAT AREA : 36 m<sup>2</sup>

TERRACE AREA : 4,93 m<sup>2</sup>

TOTAL FLAT AREA : 41 m<sup>2</sup>



1ST FLOOR

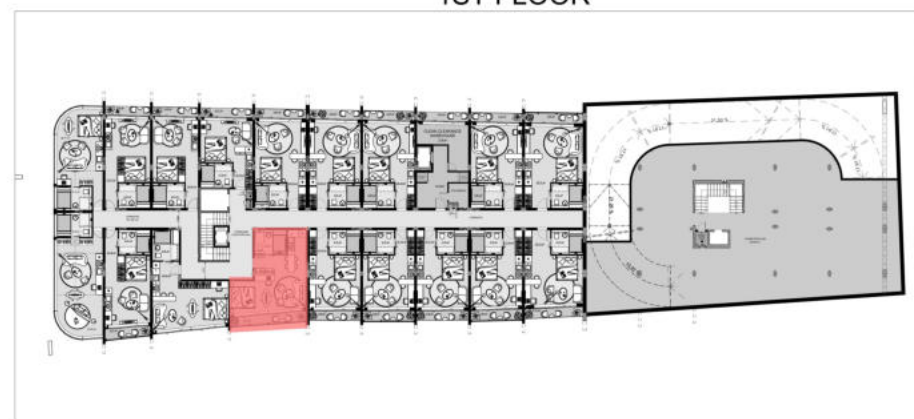

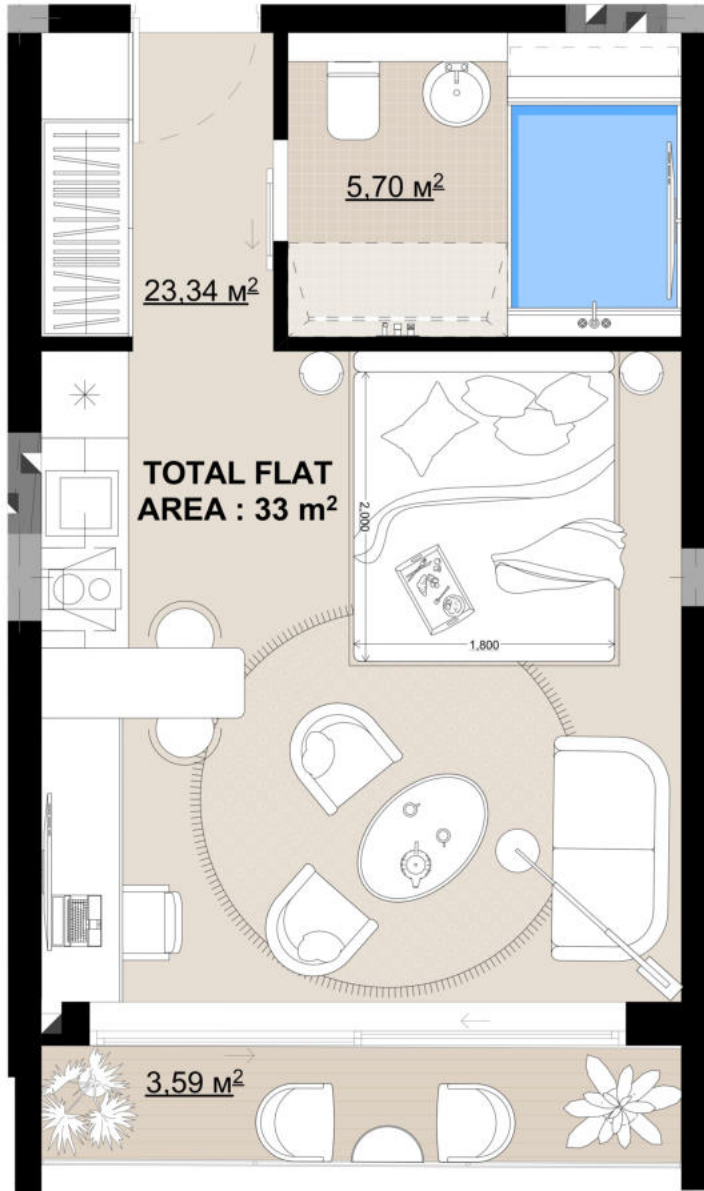

## SECTION "A"

UNIT 26

FLAT AREA : 29,04 m<sup>2</sup>

TERRACE AREA : 3,59 m<sup>2</sup>

TOTAL FLAT AREA : 33 m<sup>2</sup>



1ST FLOOR

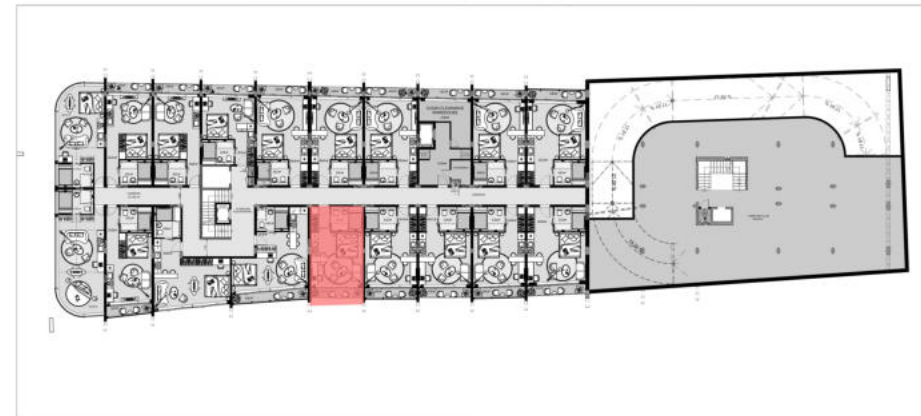

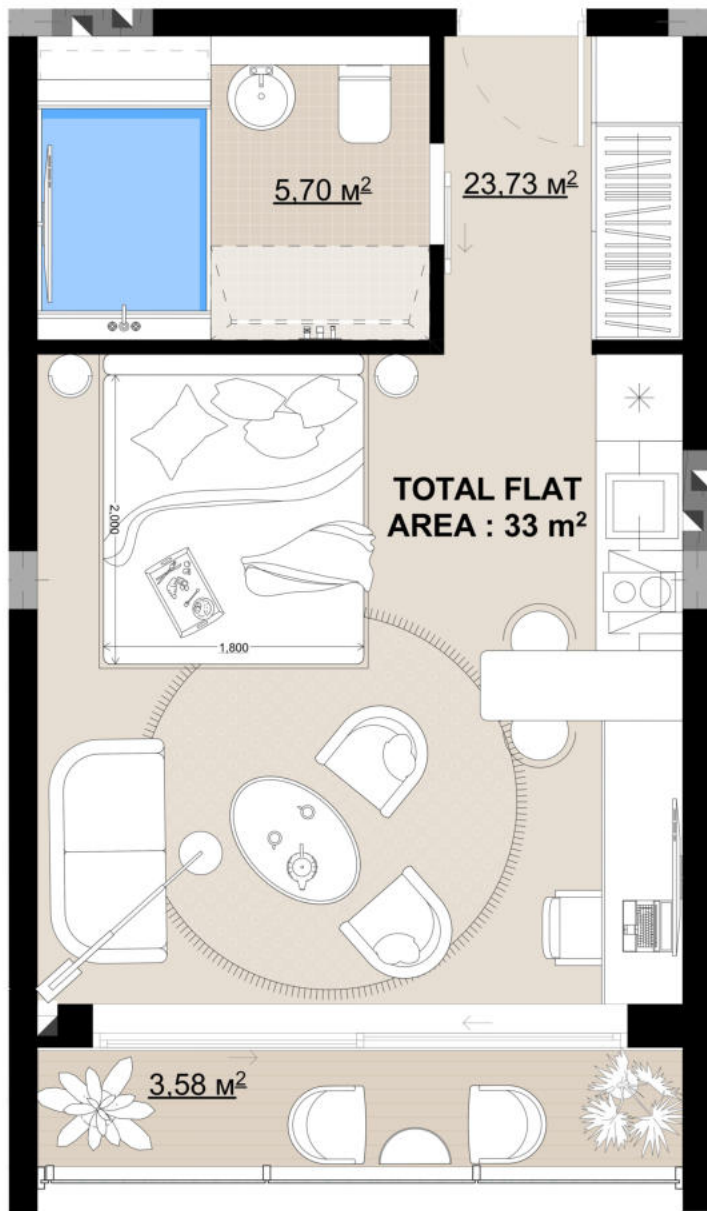

## SECTION "A"

UNIT 25

FLAT AREA : 29,43 m<sup>2</sup>

TERRACE AREA : 3,58 m<sup>2</sup>

TOTAL FLAT AREA : 33 m<sup>2</sup>



1ST FLOOR

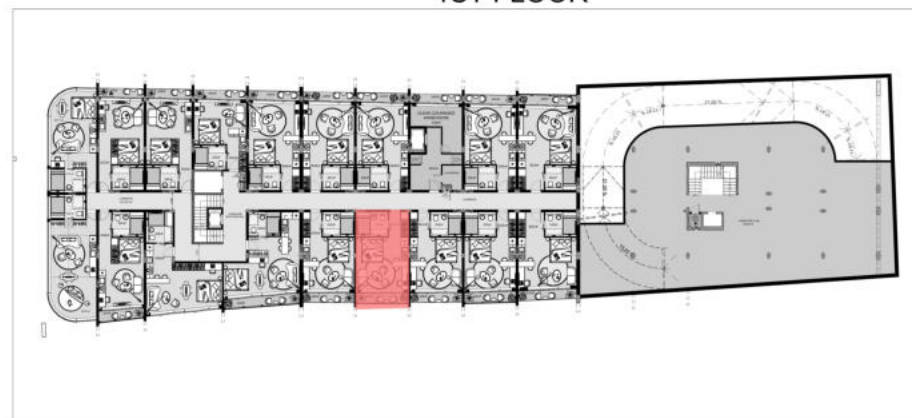

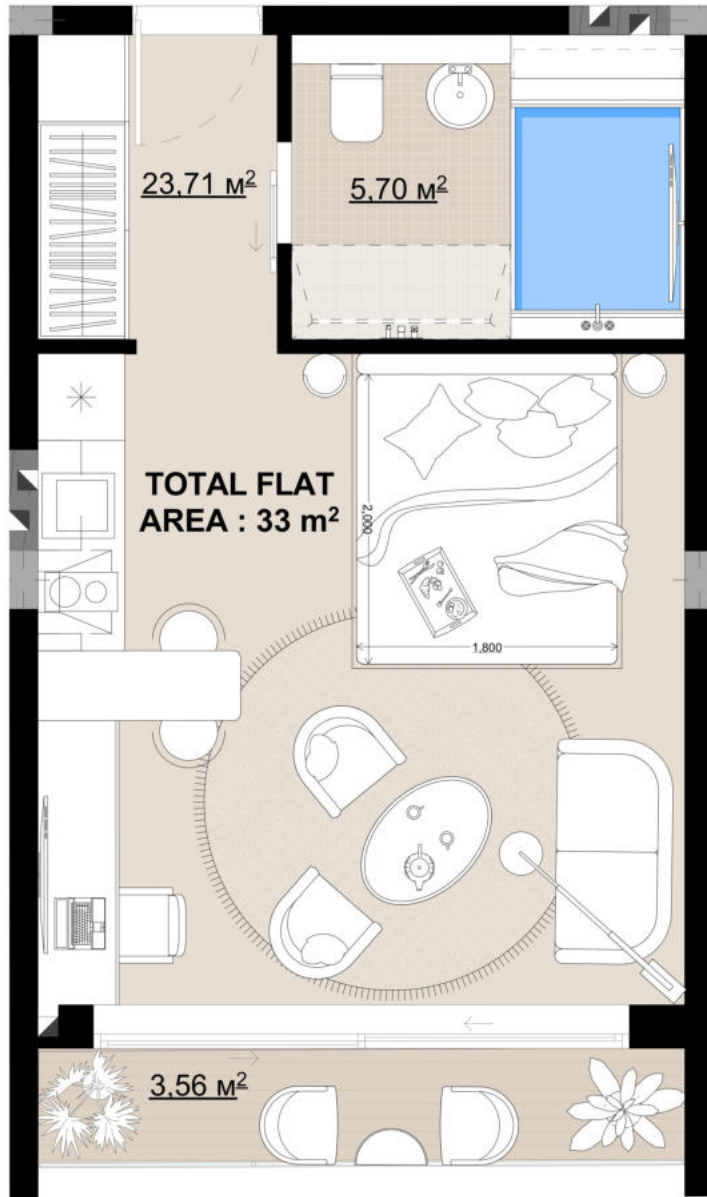

## SECTION "A"

UNIT 24

FLAT AREA : 29,41 m<sup>2</sup>

TERRACE AREA : 3,56 m<sup>2</sup>

TOTAL FLAT AREA : 33 m<sup>2</sup>



1ST FLOOR

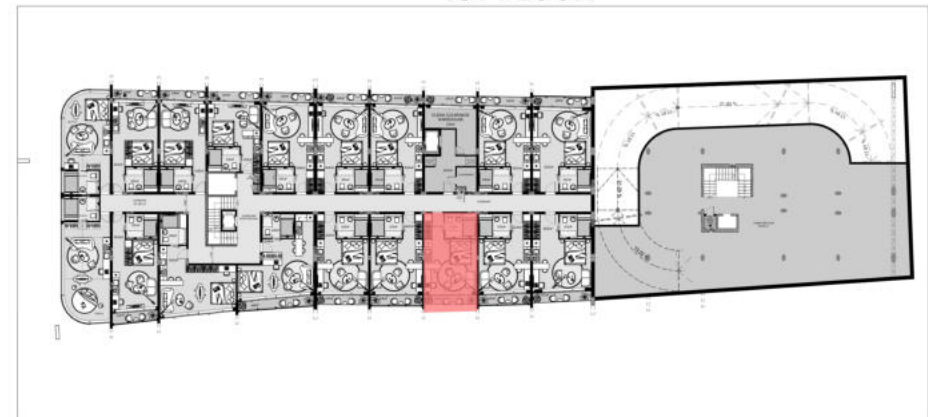

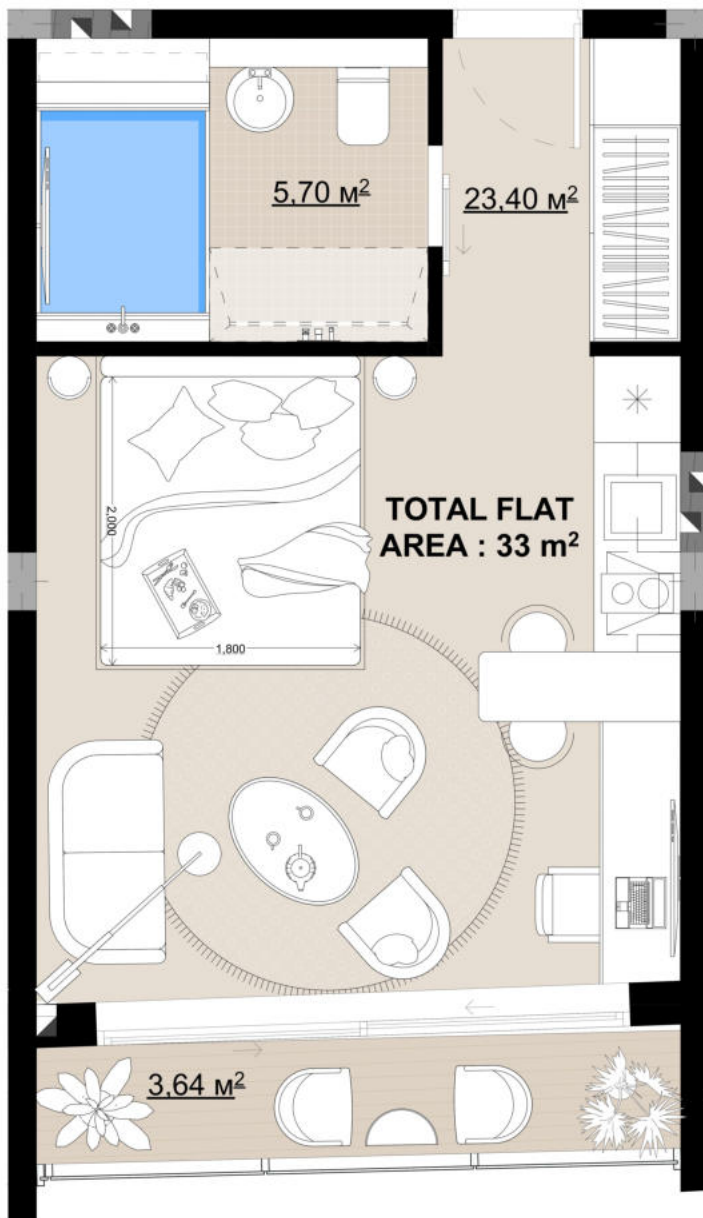

## SECTION "A"

UNIT 23

FLAT AREA : 29,1 m<sup>2</sup>

TERRACE AREA : 3,64 m<sup>2</sup>

TOTAL FLAT AREA : 33 m<sup>2</sup>



1ST FLOOR

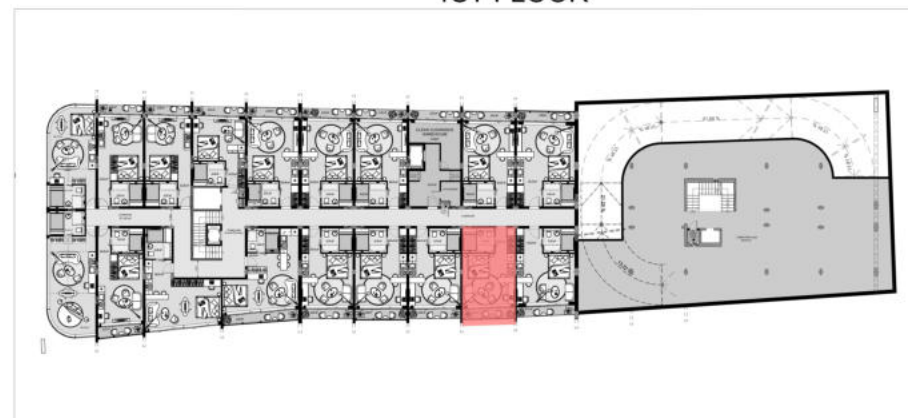

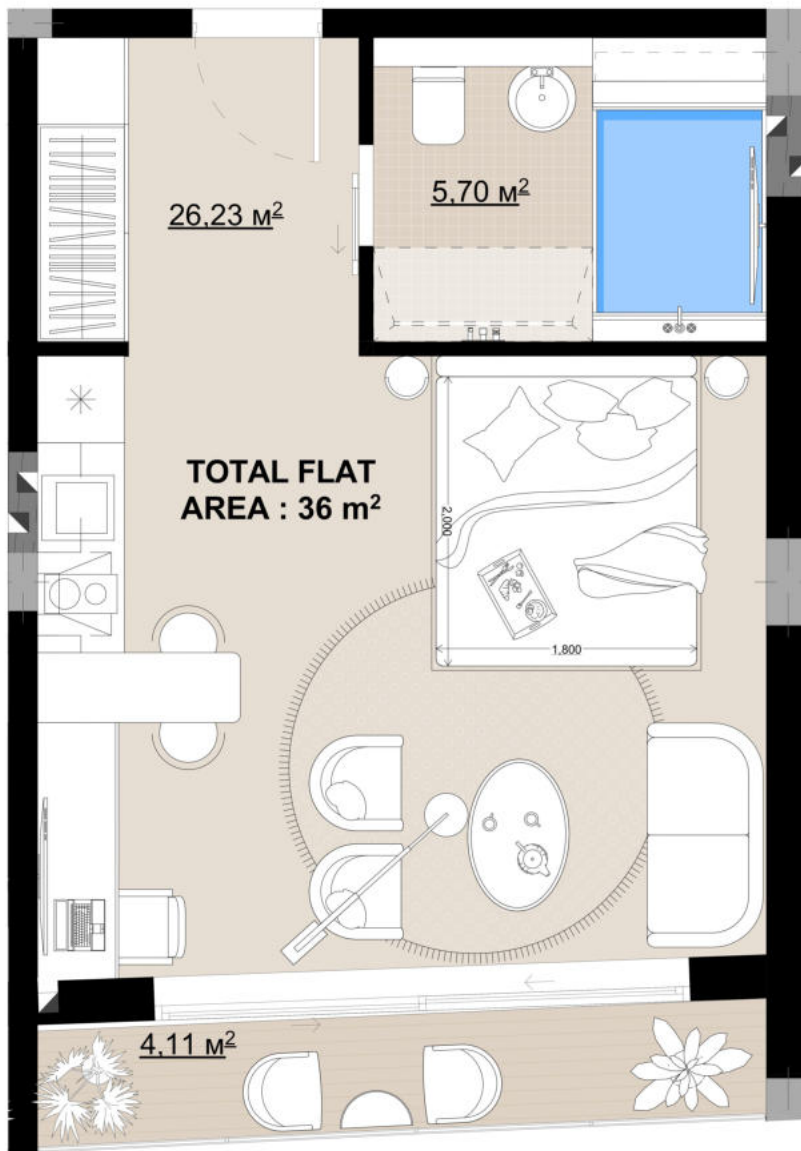

## SECTION "A"

UNIT 22

FLAT AREA : 31.93 m<sup>2</sup>

TERRACE AREA : 4,11 m<sup>2</sup>

TOTAL FLAT AREA : 36 m<sup>2</sup>



1ST FLOOR

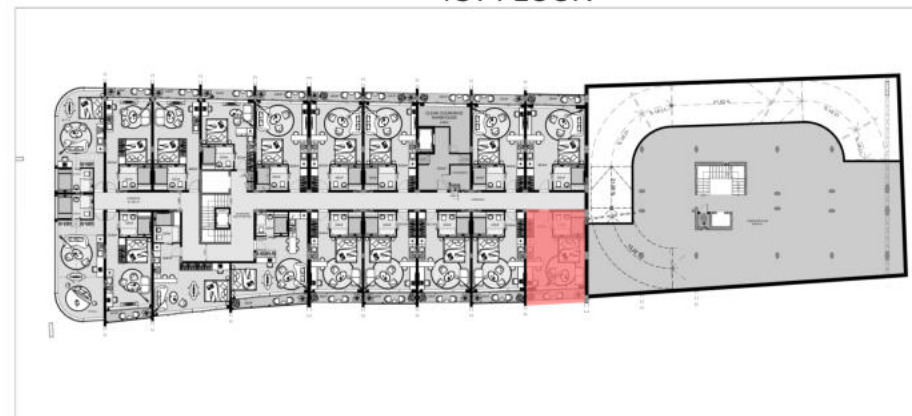

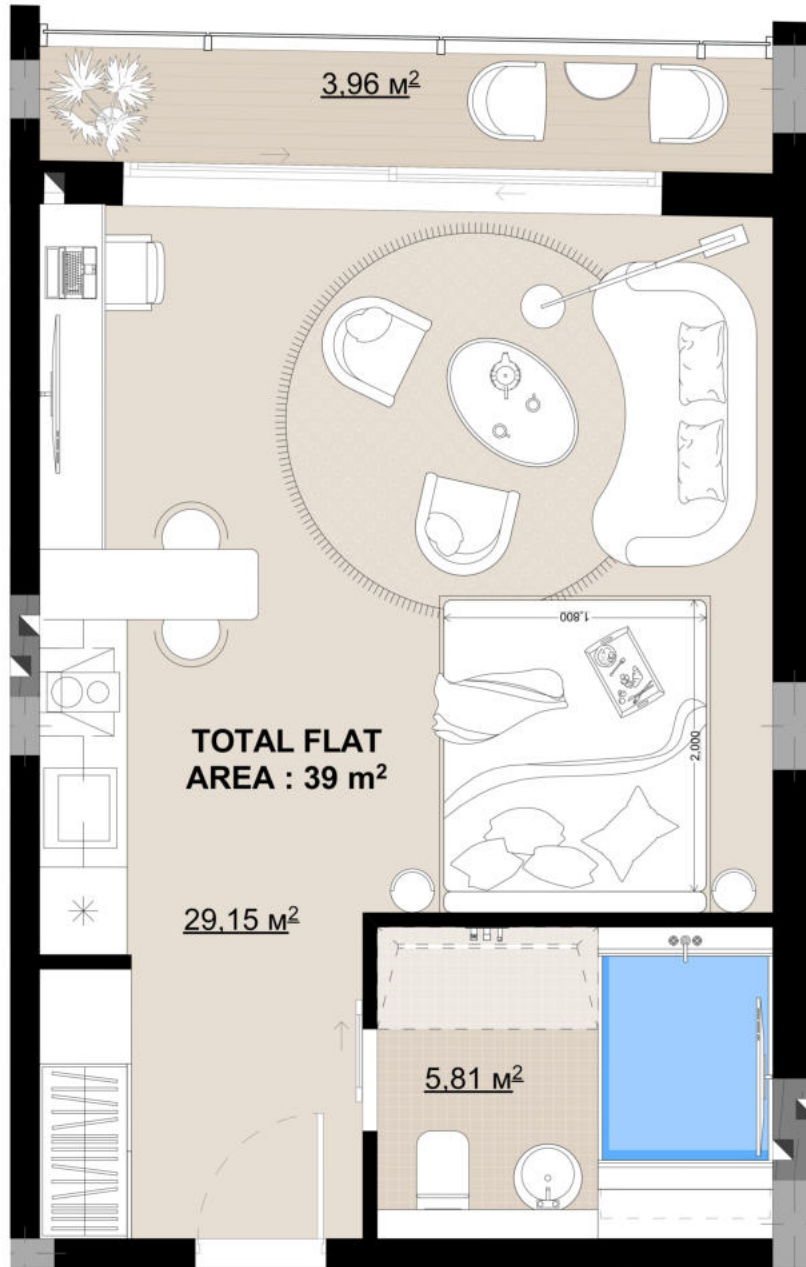

## SECTION "A"

UNIT 21

FLAT AREA : 34,96 m<sup>2</sup>

TERRACE AREA : 3.96 m<sup>2</sup>

TOTAL FLAT AREA : 39 m<sup>2</sup>



1ST FLOOR

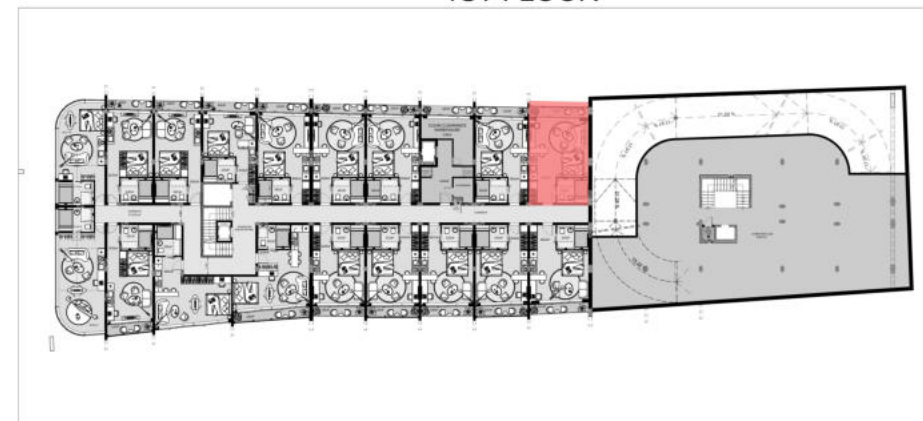

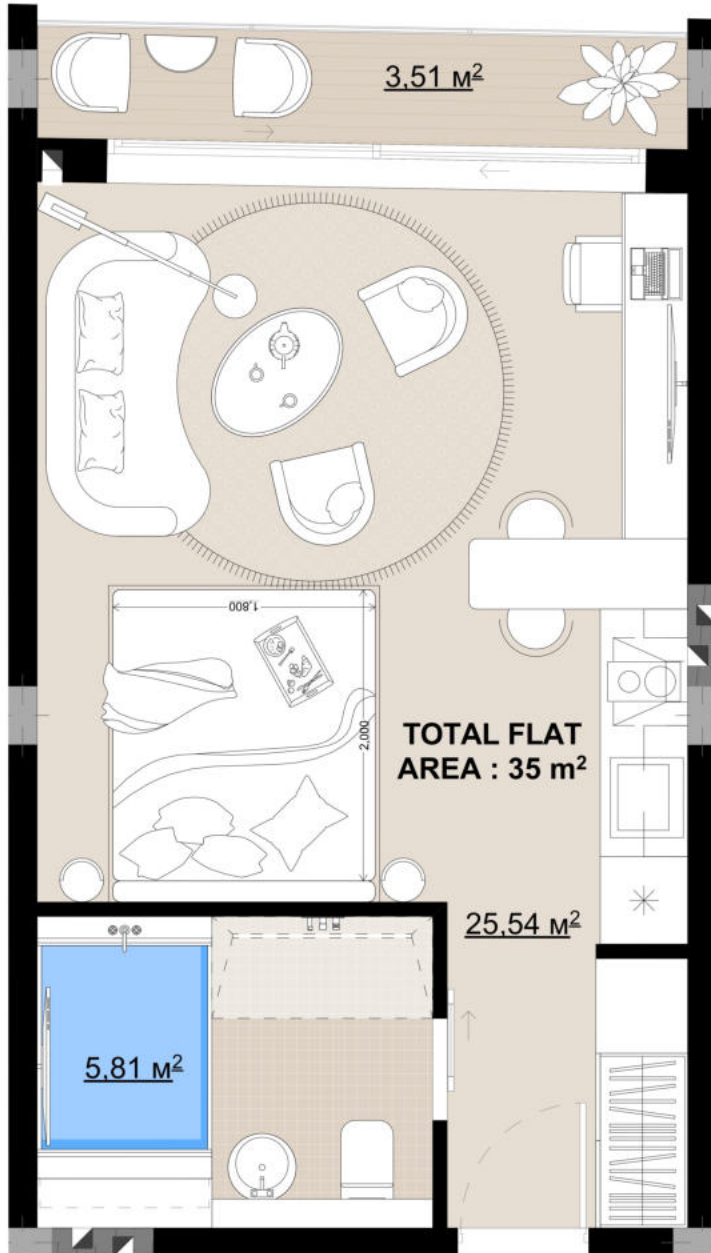

## SECTION "A"

UNIT 20

FLAT AREA : 31.35 m<sup>2</sup>

TERRACE AREA : 3.51 m<sup>2</sup>

TOTAL FLAT AREA : 35 m<sup>2</sup>



1ST FLOOR

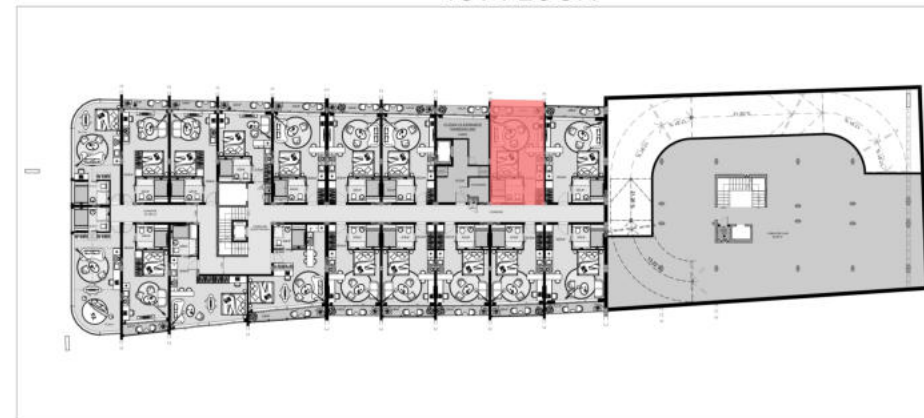

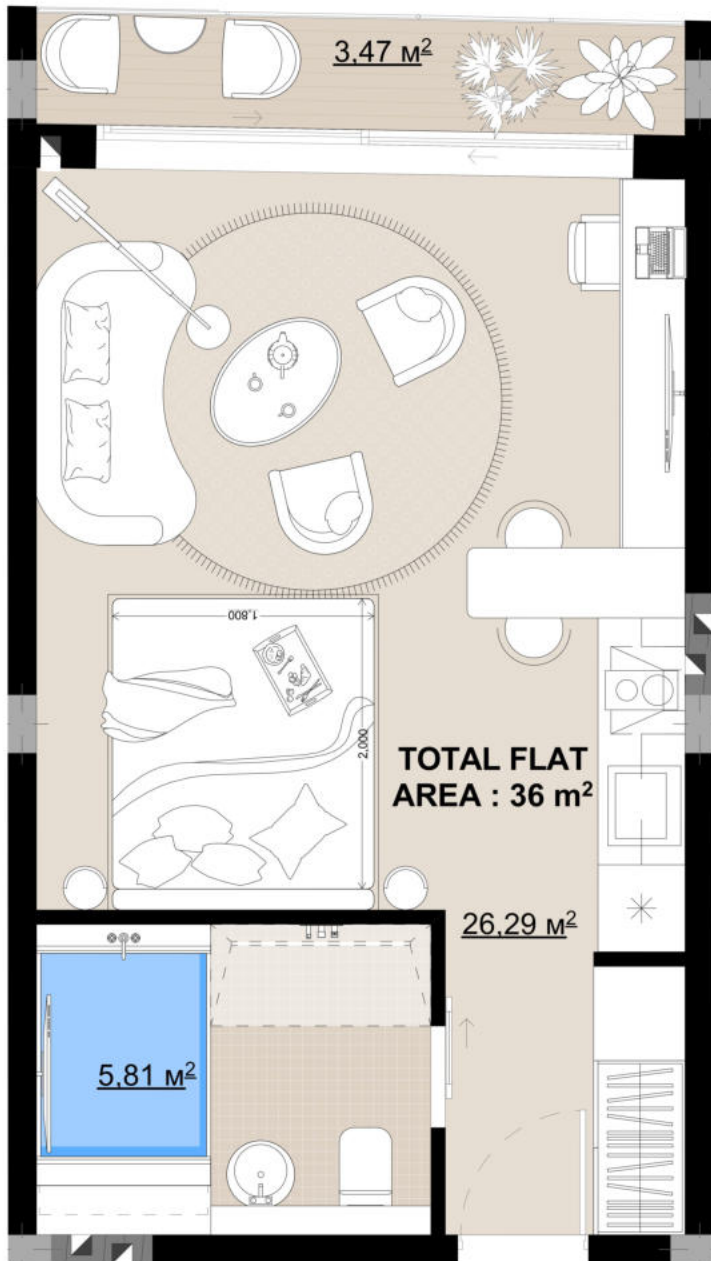

## SECTION "A"

UNIT 19

FLAT AREA : 32,1 m<sup>2</sup>

TERRACE AREA : 3,47 m<sup>2</sup>

**TOTAL FLAT AREA : 36 m<sup>2</sup>**



1ST FLOOR

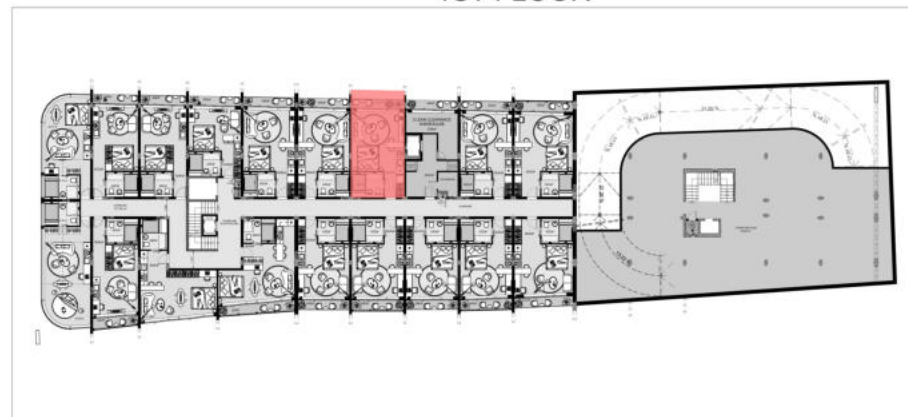

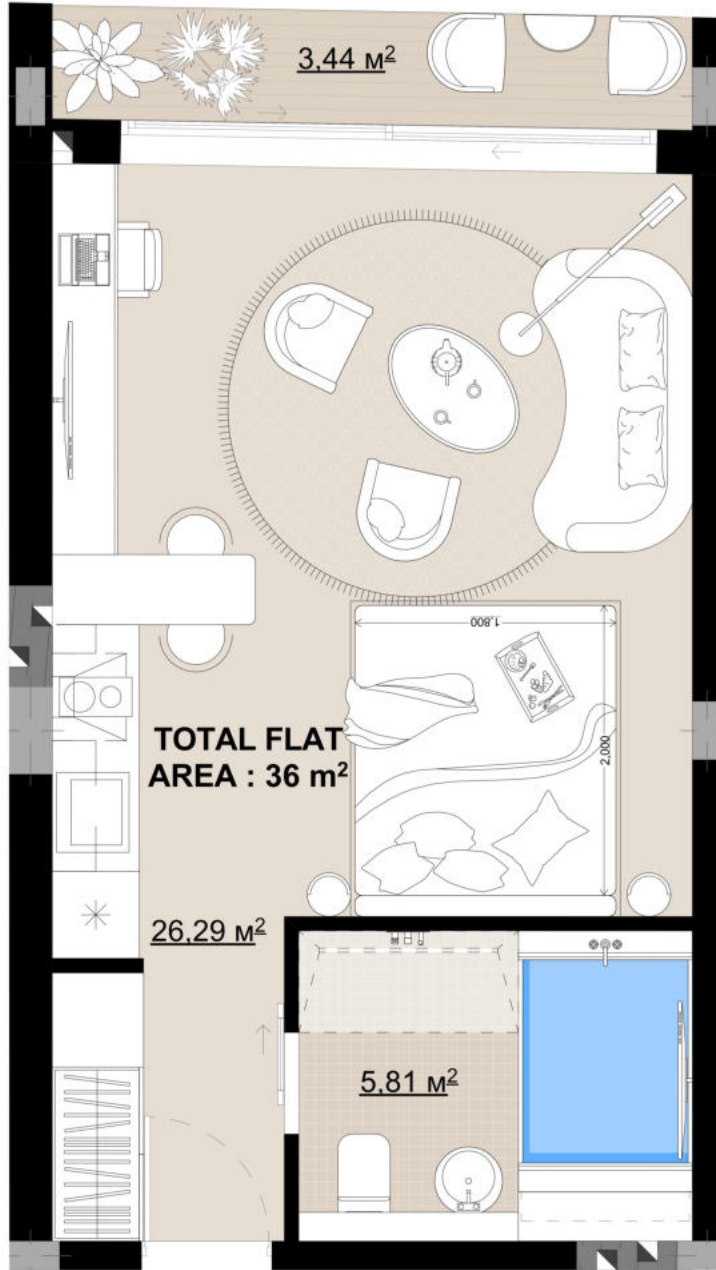

## SECTION "A"

UNIT 18

FLAT AREA : 32,1 m<sup>2</sup>

TERRACE AREA : 3,44 m<sup>2</sup>

TOTAL FLAT AREA : 36 m<sup>2</sup>



1ST FLOOR

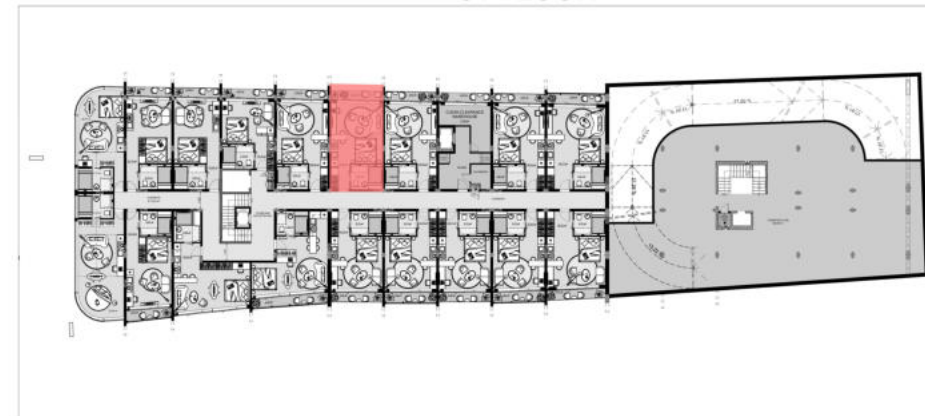

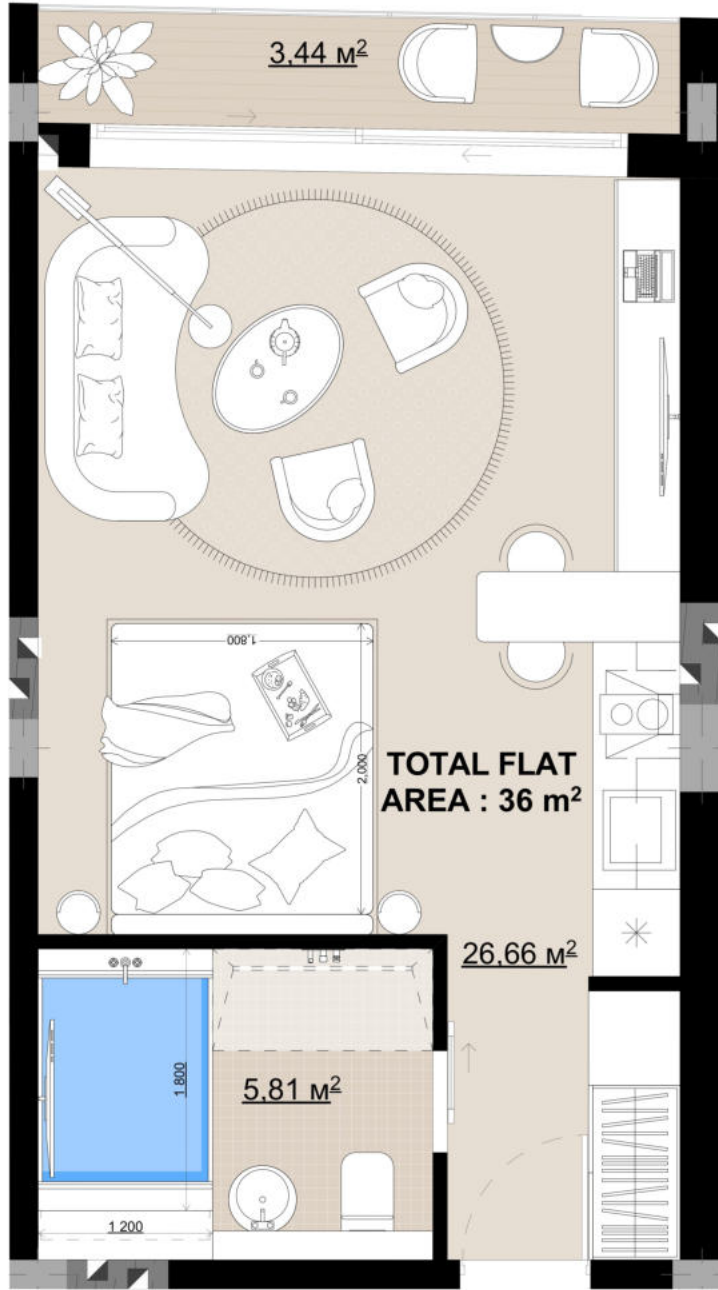

## SECTION "A"

UNIT 17

FLAT AREA : 32,47 m<sup>2</sup>

TERRACE AREA : 3,44 m<sup>2</sup>

TOTAL FLAT AREA : 36 m<sup>2</sup>



1ST FLOOR

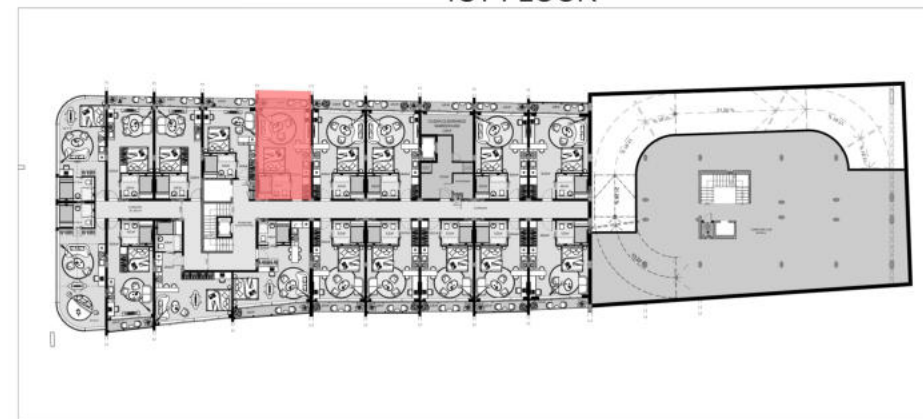

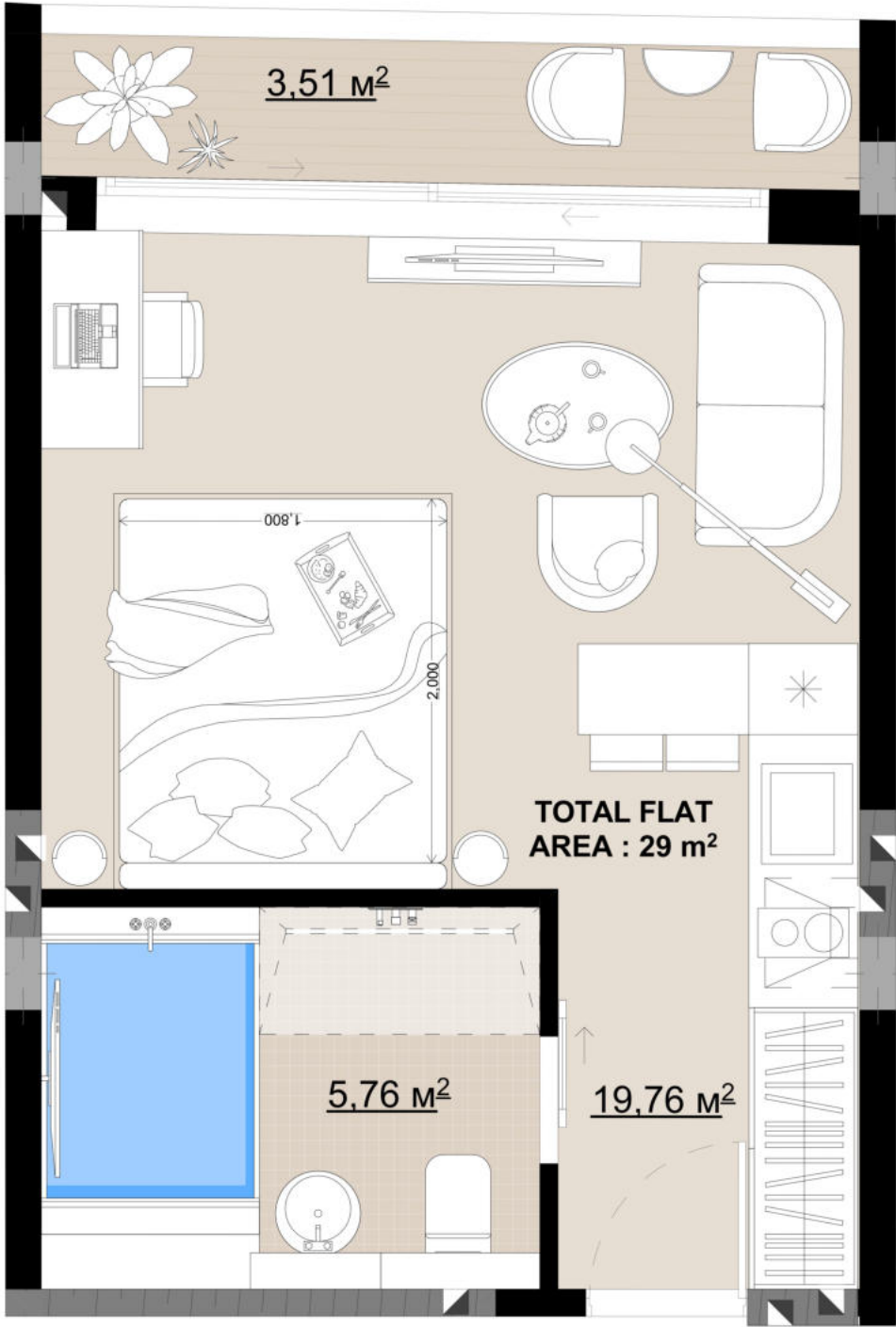

**SECTION "A"**

**UNIT 16**  
FLAT AREA : 25.52 m<sup>2</sup>  
TERRACE AREA : 3.51 m<sup>2</sup>  
TOTAL FLAT AREA : 29 m<sup>2</sup>



1ST FLOOR

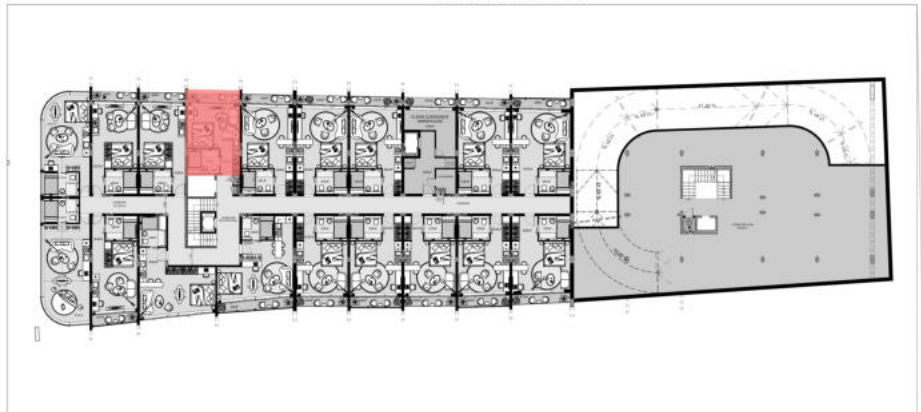

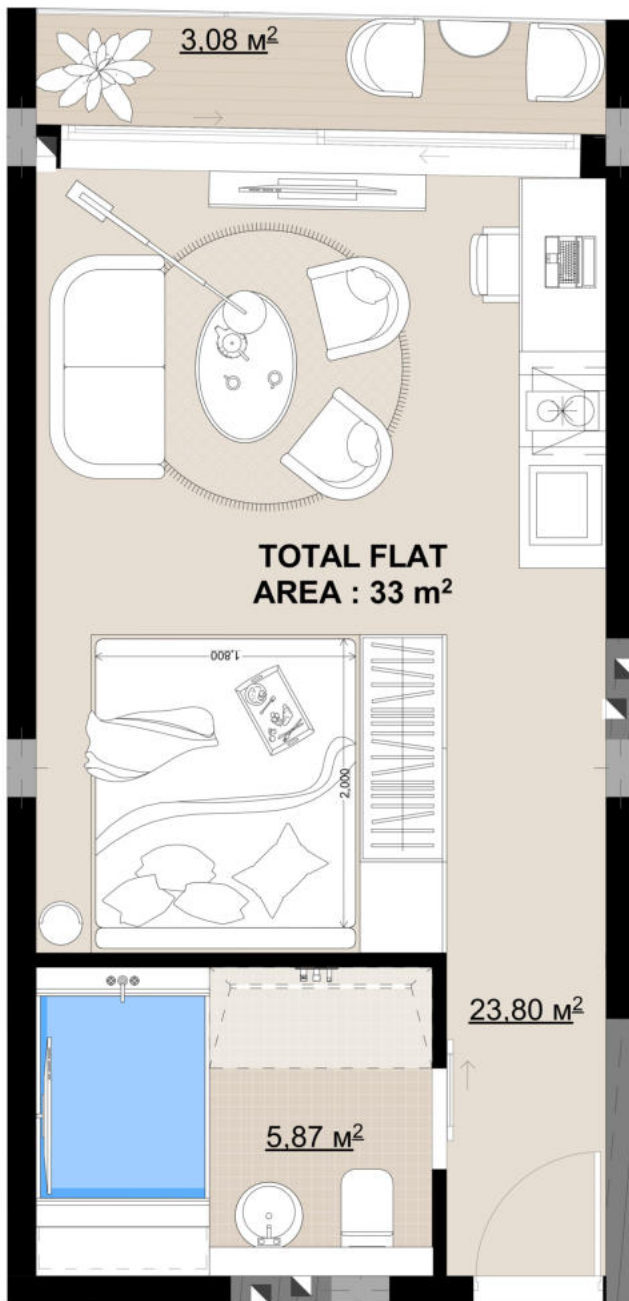

## SECTION "A"

UNIT 15

FLAT AREA : 29,67 m<sup>2</sup>

TERRACE AREA : 3,08 m<sup>2</sup>

TOTAL FLAT AREA : 33 m<sup>2</sup>



1ST FLOOR

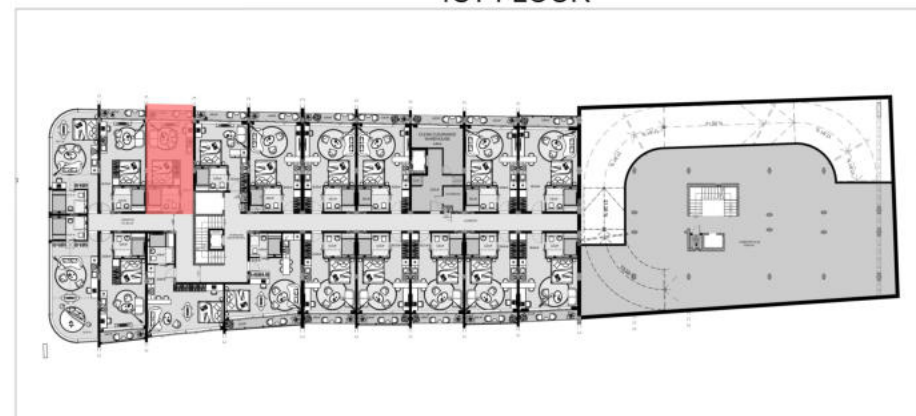

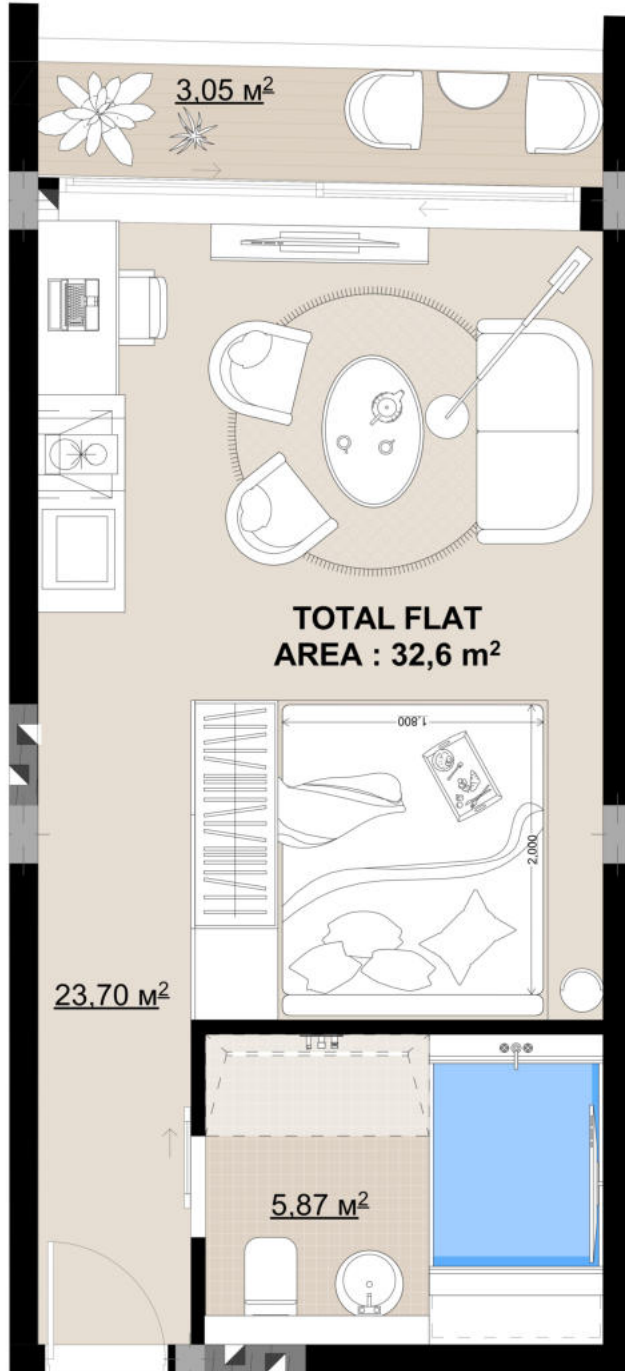

## SECTION "A"

UNIT 14

FLAT AREA : 29,57 m<sup>2</sup>

TERRACE AREA : 3.05 m<sup>2</sup>

**TOTAL FLAT AREA : 32.6 m<sup>2</sup>**



1ST FLOOR

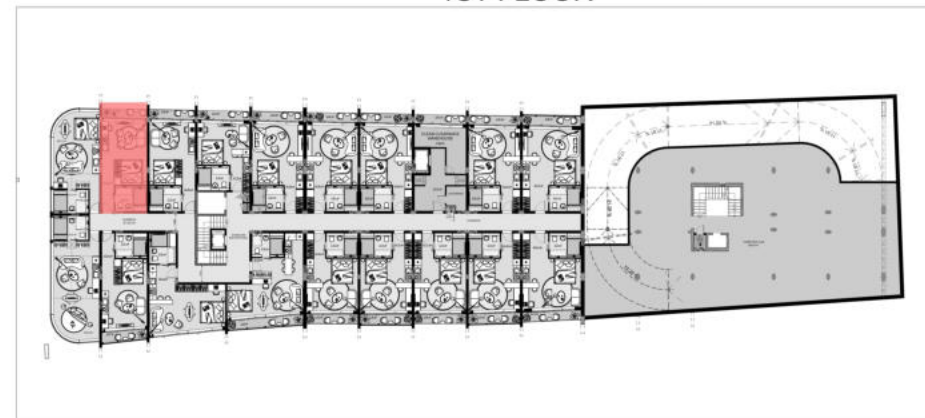

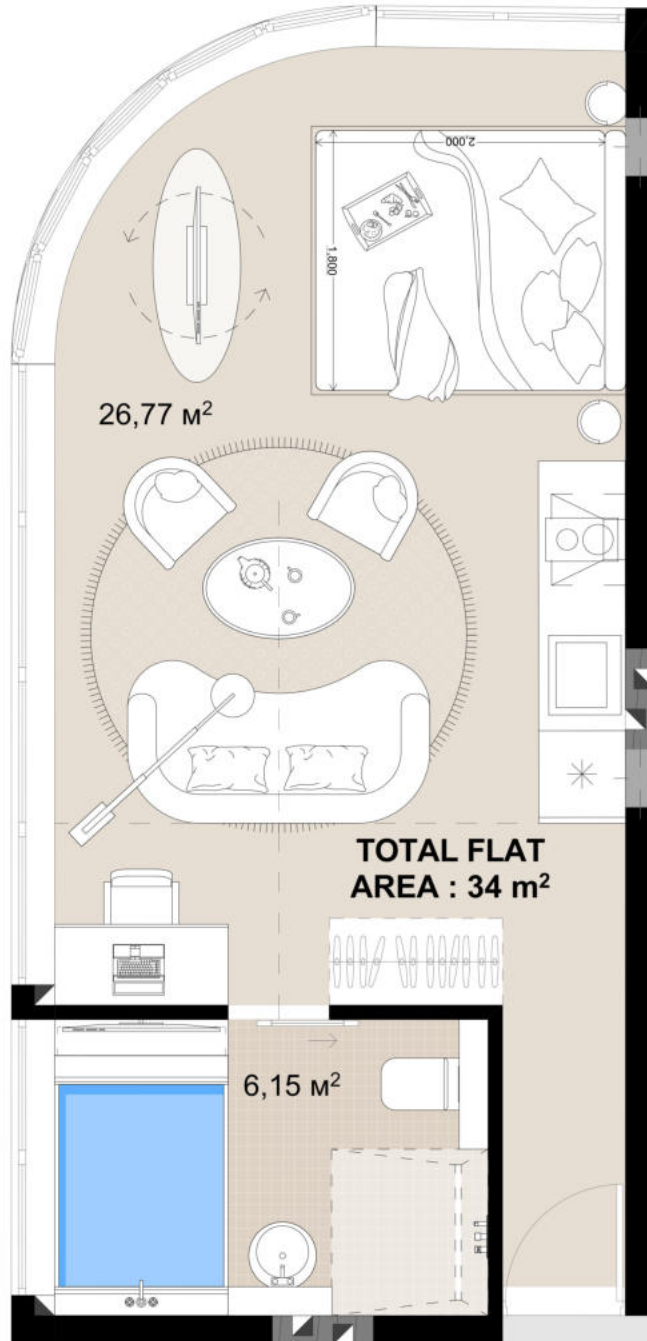

## SECTION "A"

UNIT 12

FLAT AREA : 34 m<sup>2</sup>

TERRACE AREA : 0.00 m<sup>2</sup>

TOTAL FLAT AREA : 34 m<sup>2</sup>



1ST FLOOR

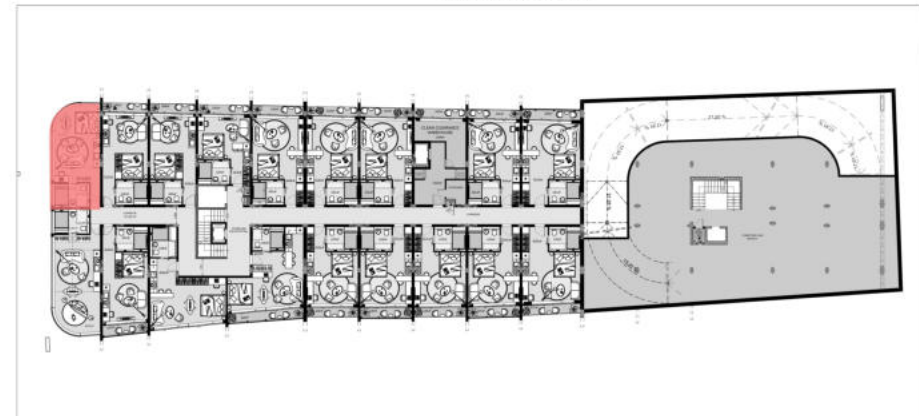

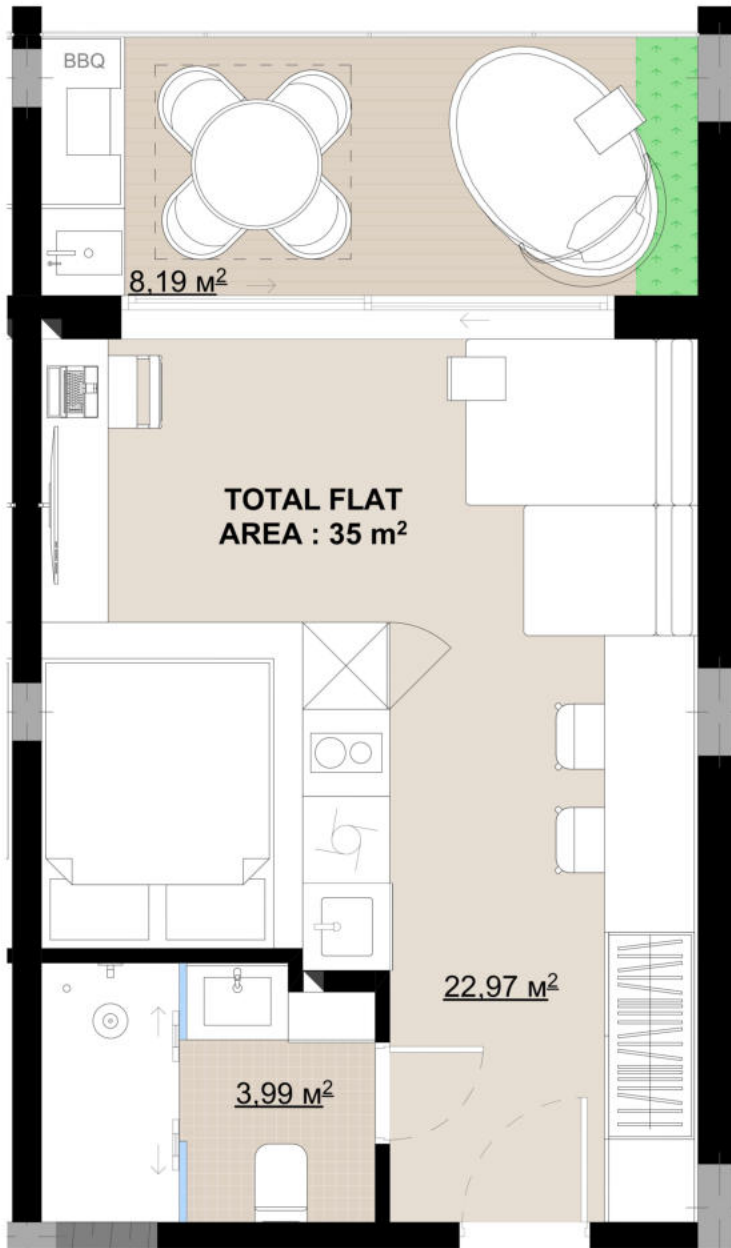

## SECTION "B"

SUITE 150

FLAT AREA : 26,96 m<sup>2</sup>

TERRACE AREA : 8,19 m<sup>2</sup>

TOTAL FLAT AREA : 35 m<sup>2</sup>



6TH FLOOR

SECTION "A" SECTION "B"

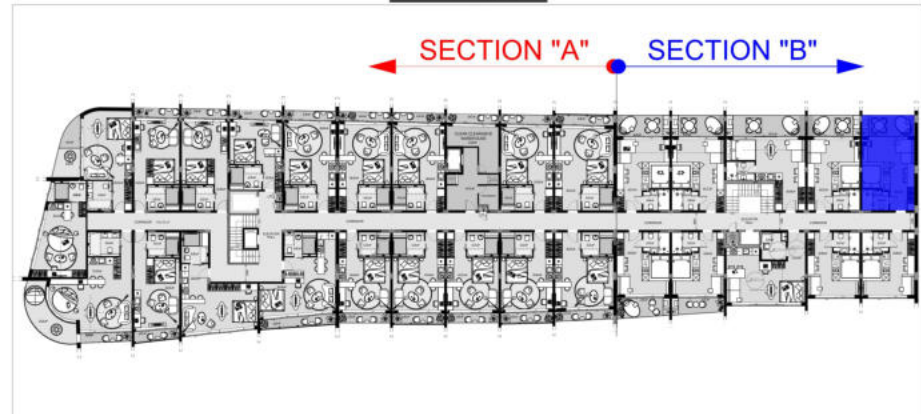

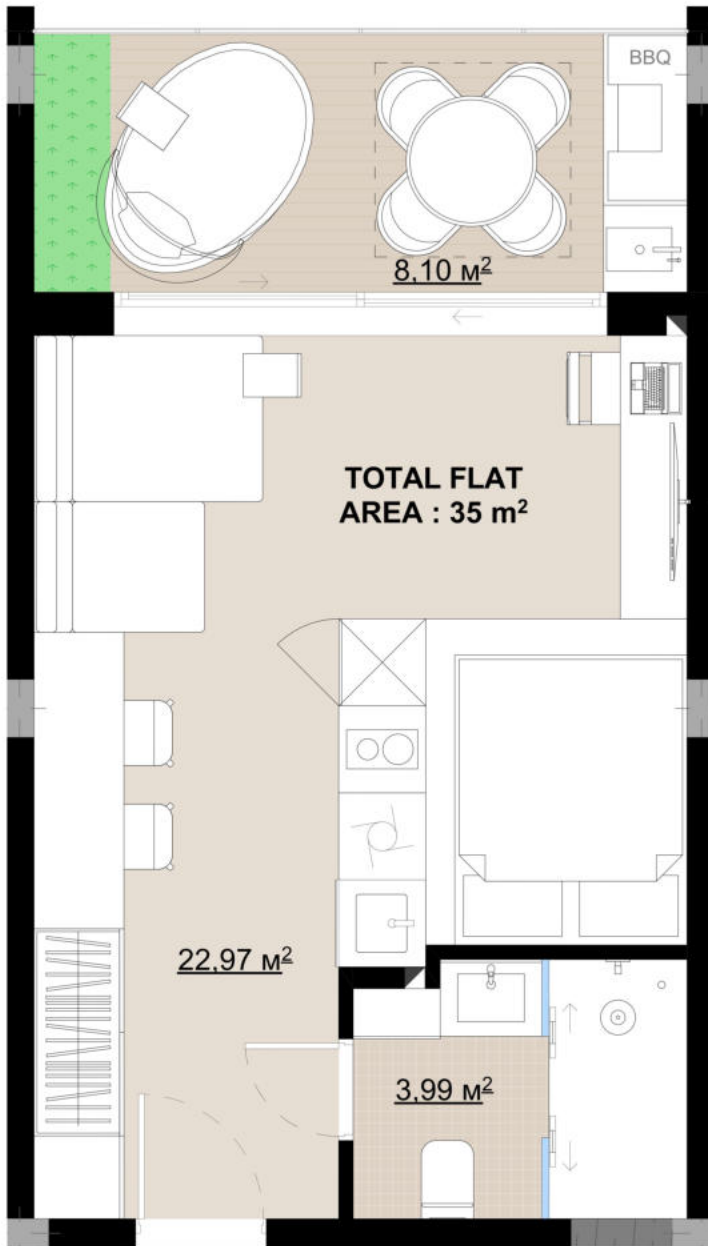

## SECTION "B"

SUITE 149

FLAT AREA : 26,96 m<sup>2</sup>

TERRACE AREA : 8,10 m<sup>2</sup>

TOTAL FLAT AREA : 35 m<sup>2</sup>



6TH FLOOR

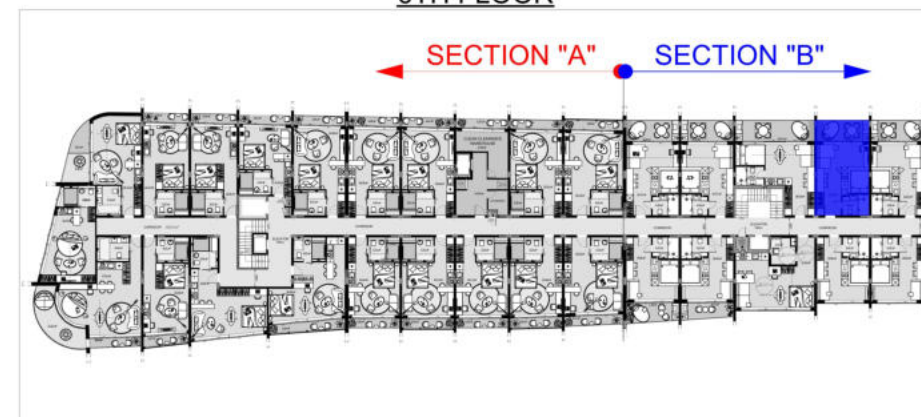



### SECTION "B"

SUITE 148

FLAT AREA : 29,97 m<sup>2</sup>

TERRACE AREA : 12,31 m<sup>2</sup>

TOTAL FLAT AREA : 42 m<sup>2</sup>

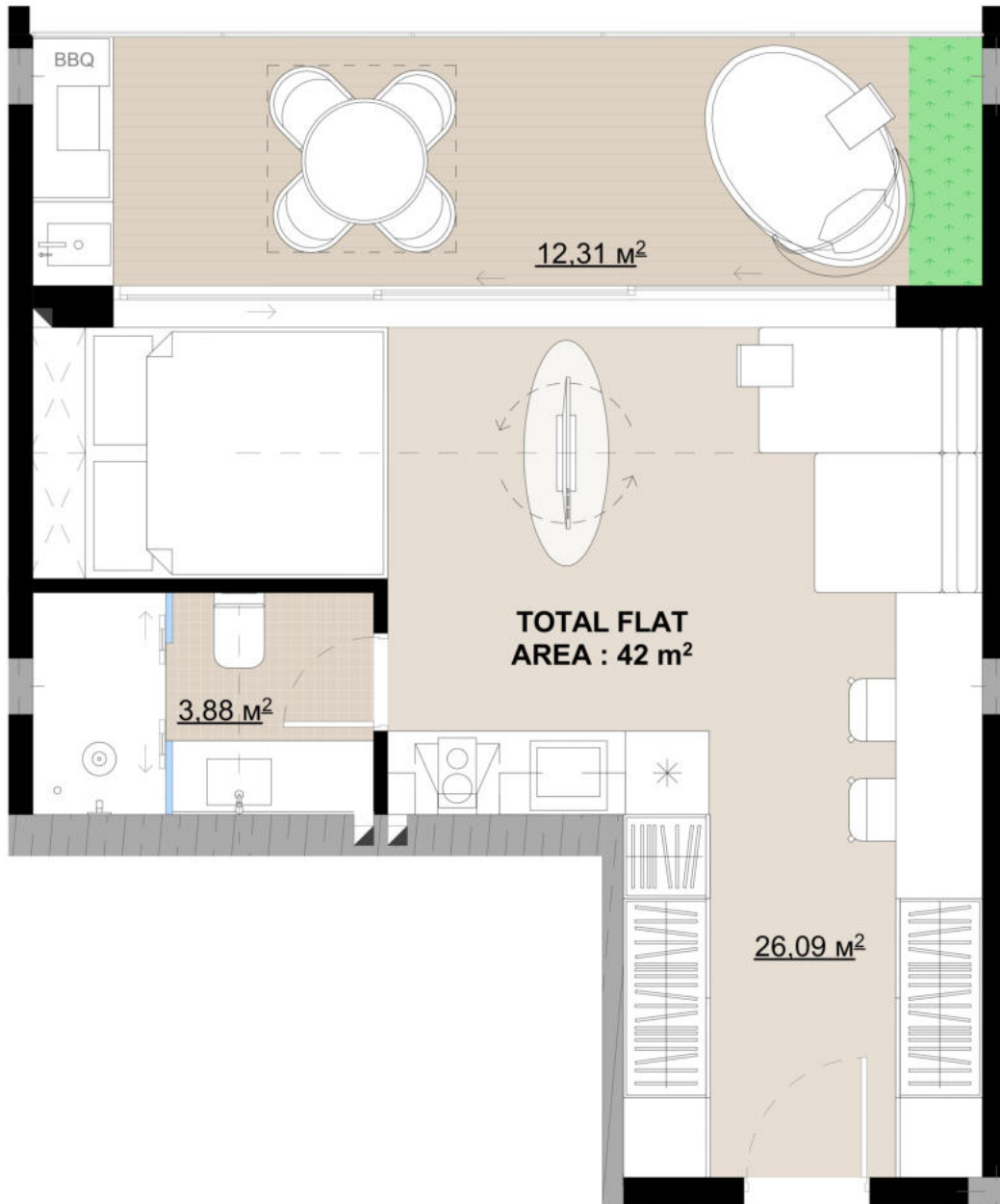

6TH FLOOR

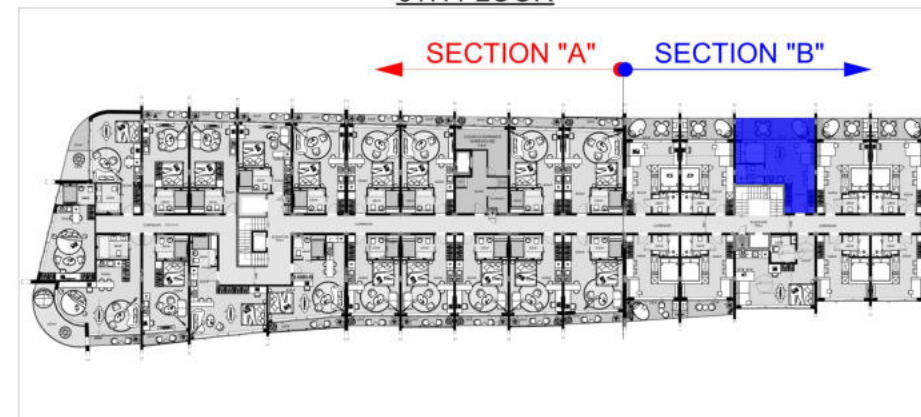

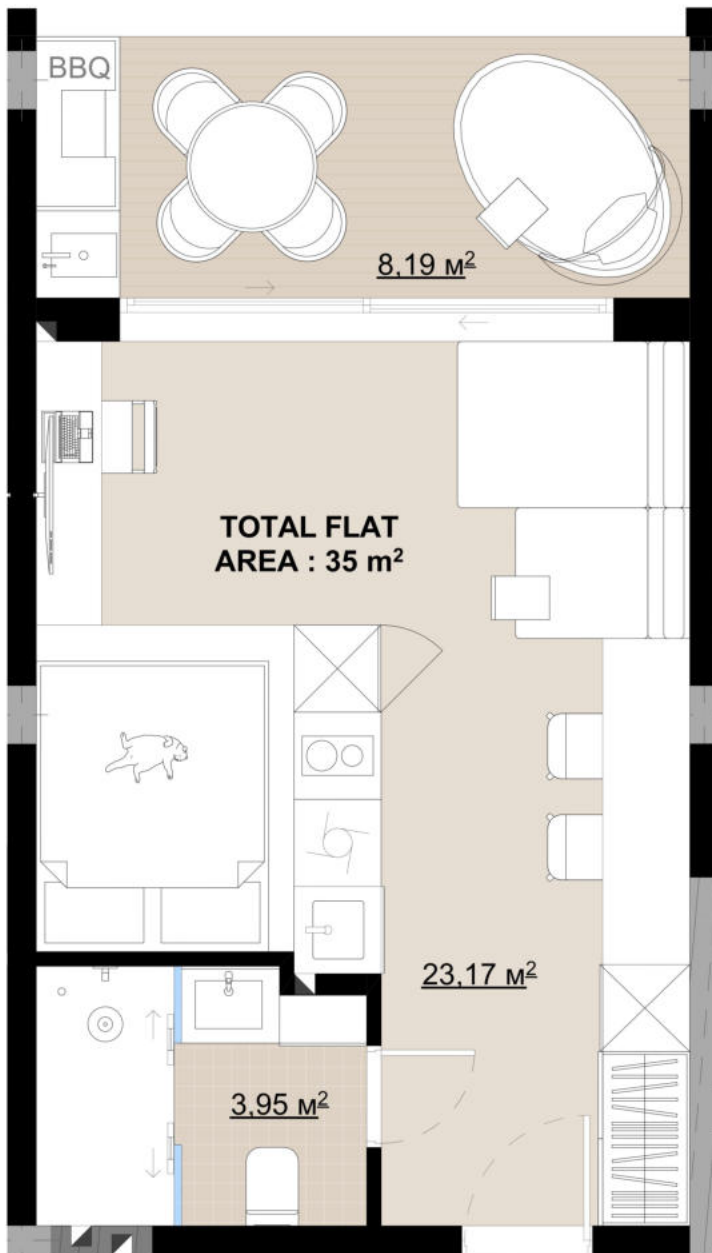

## SECTION "B"

SUITE 147

FLAT AREA : 27,12 m<sup>2</sup>

TERRACE AREA : 8,19 m<sup>2</sup>

TOTAL FLAT AREA : 35 m<sup>2</sup>



6TH FLOOR

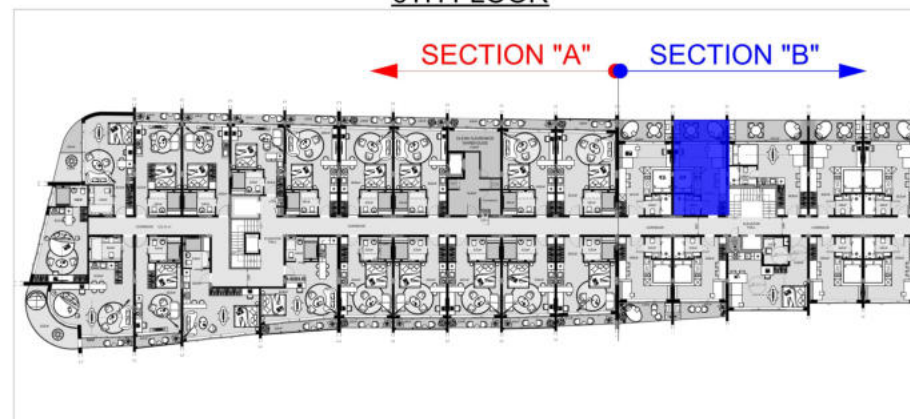

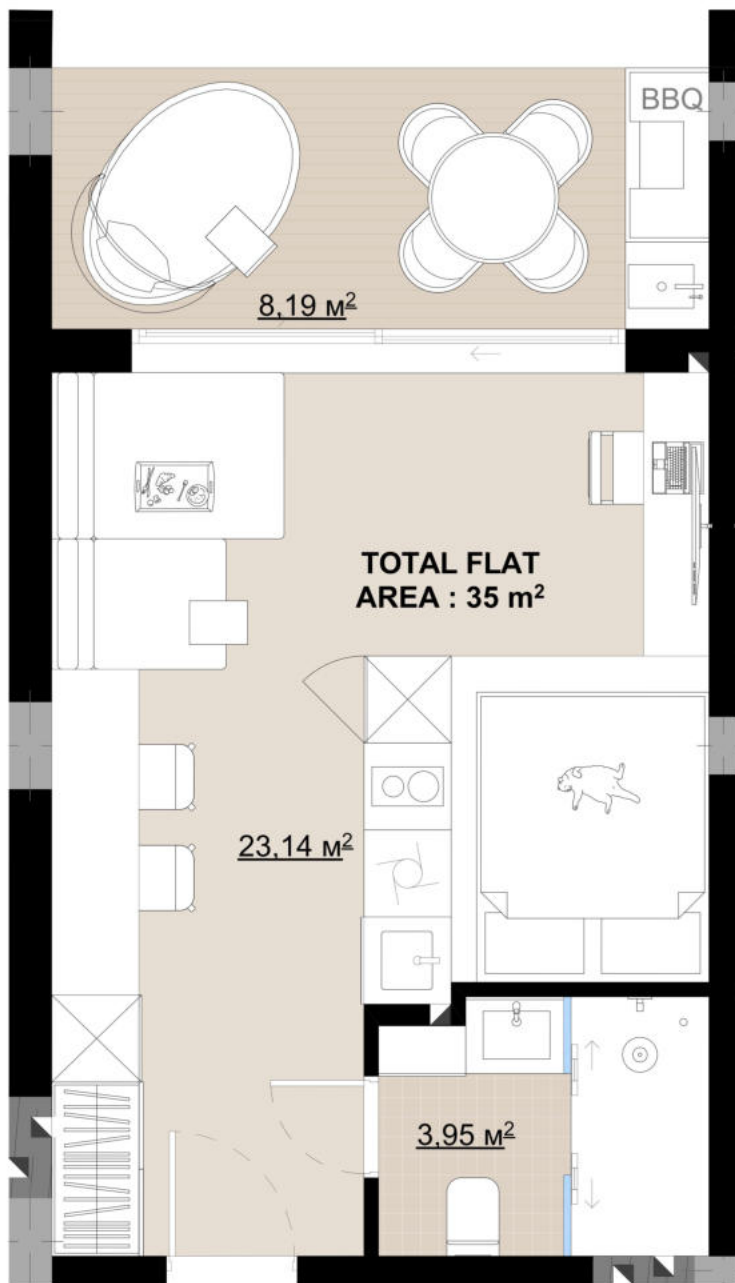

## SECTION "B"

SUITE 146

FLAT AREA : 27,12 m<sup>2</sup>

TERRACE AREA : 8,19 m<sup>2</sup>

TOTAL FLAT AREA : 35 m<sup>2</sup>



6TH FLOOR

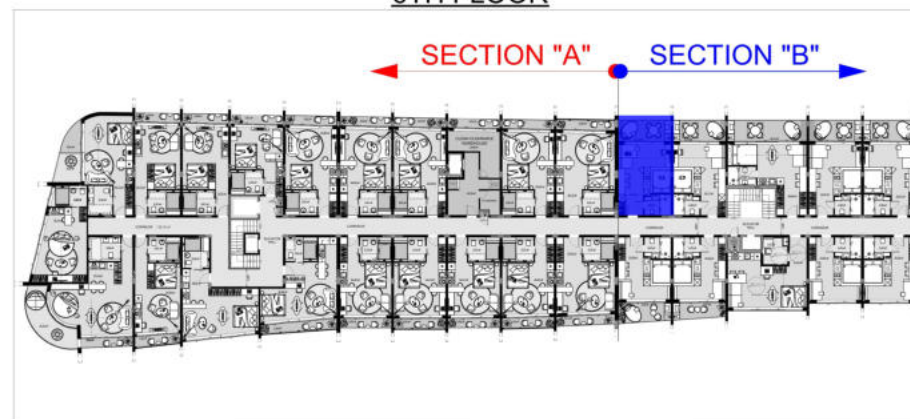

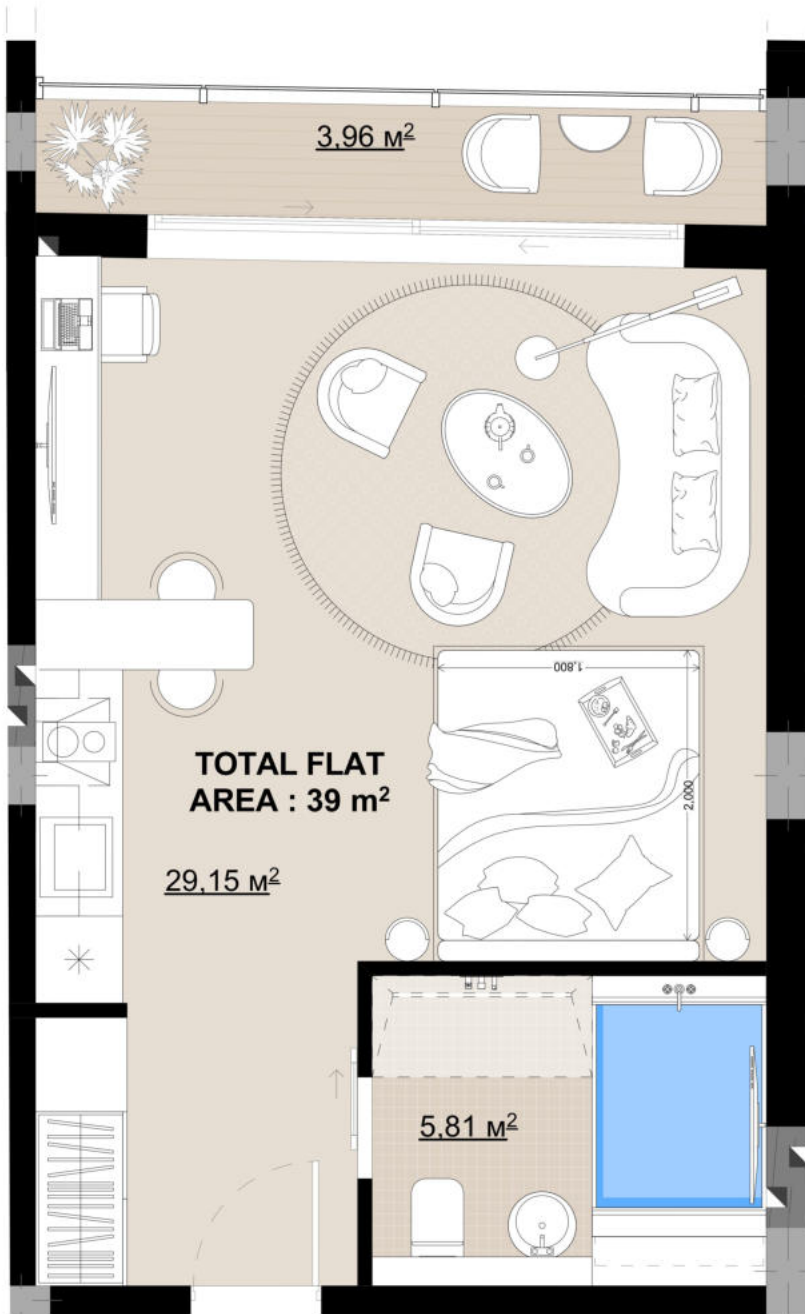

## SECTION "A"

SUITE 145

FLAT AREA : 34,96 m<sup>2</sup>

TERRACE AREA : 3.96 m<sup>2</sup>

TOTAL FLAT AREA : 39 m<sup>2</sup>



6TH FLOOR

SECTION "A" SECTION "B"

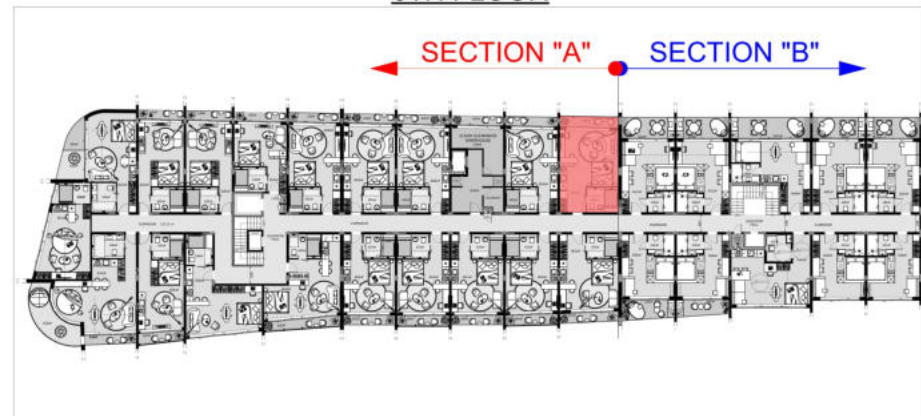

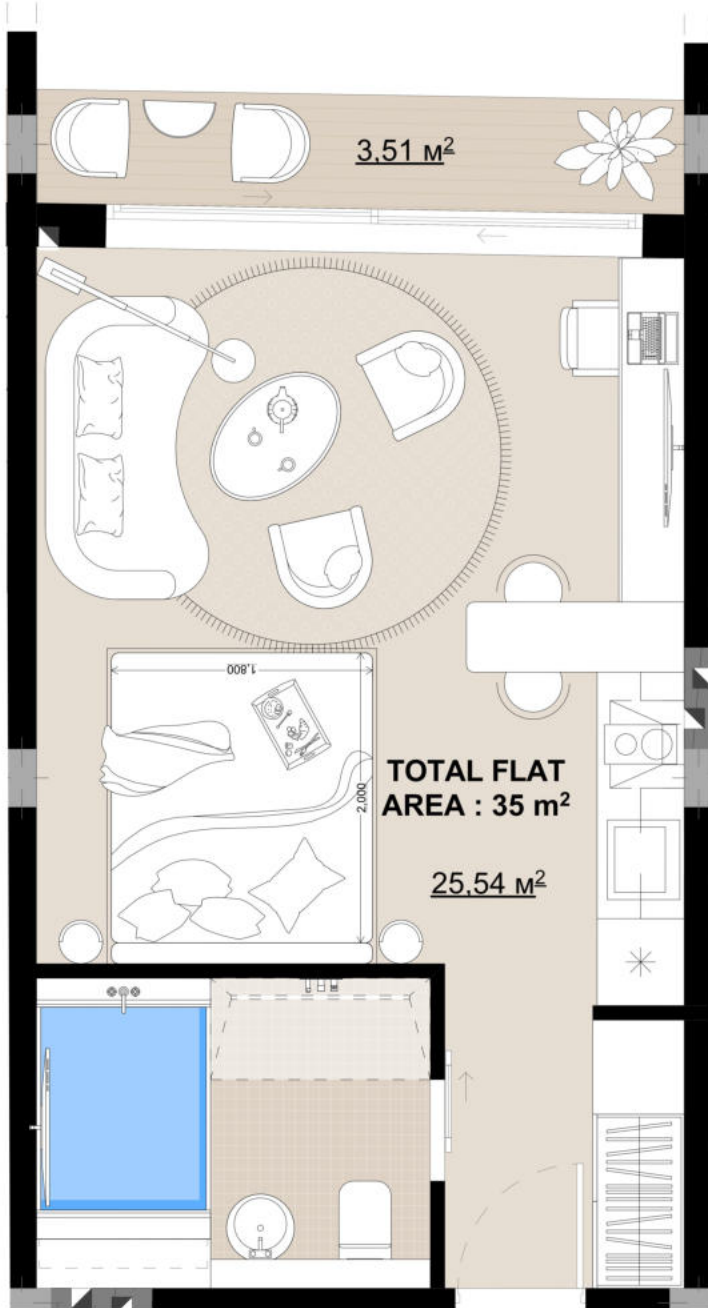

**SECTION "A"**

SUITE 144

FLAT AREA : 31.35 m<sup>2</sup>

TERRACE AREA : 3.51 m<sup>2</sup>

TOTAL FLAT AREA : 35 m<sup>2</sup>



6TH FLOOR

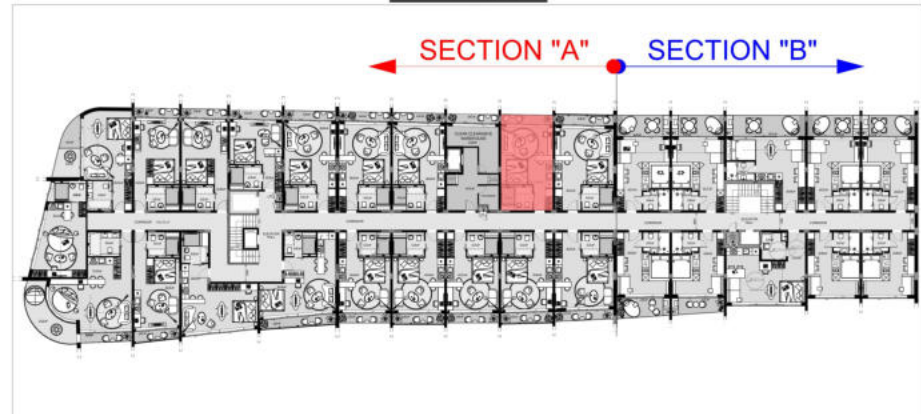

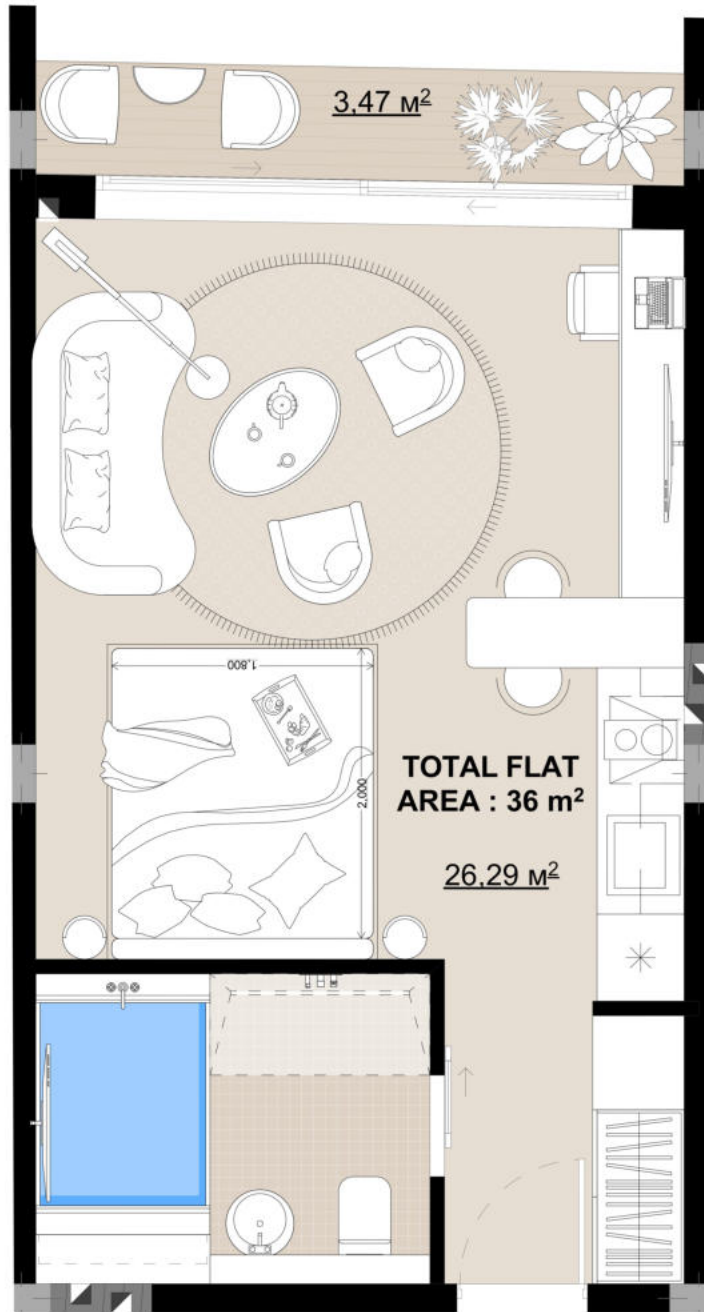

**SECTION "A"**

**SUITE 143**

**FLAT AREA : 32,1 m<sup>2</sup>**

**TERRACE AREA : 3,47 m<sup>2</sup>**

**TOTAL FLAT AREA : 36 m<sup>2</sup>**



**6TH FLOOR**

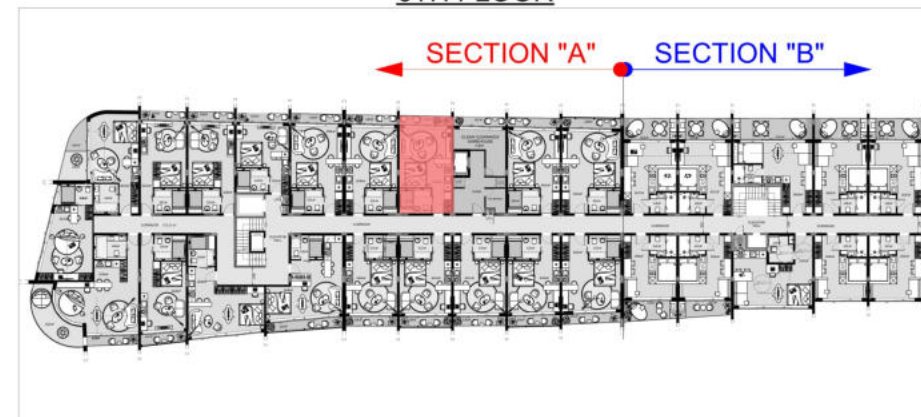

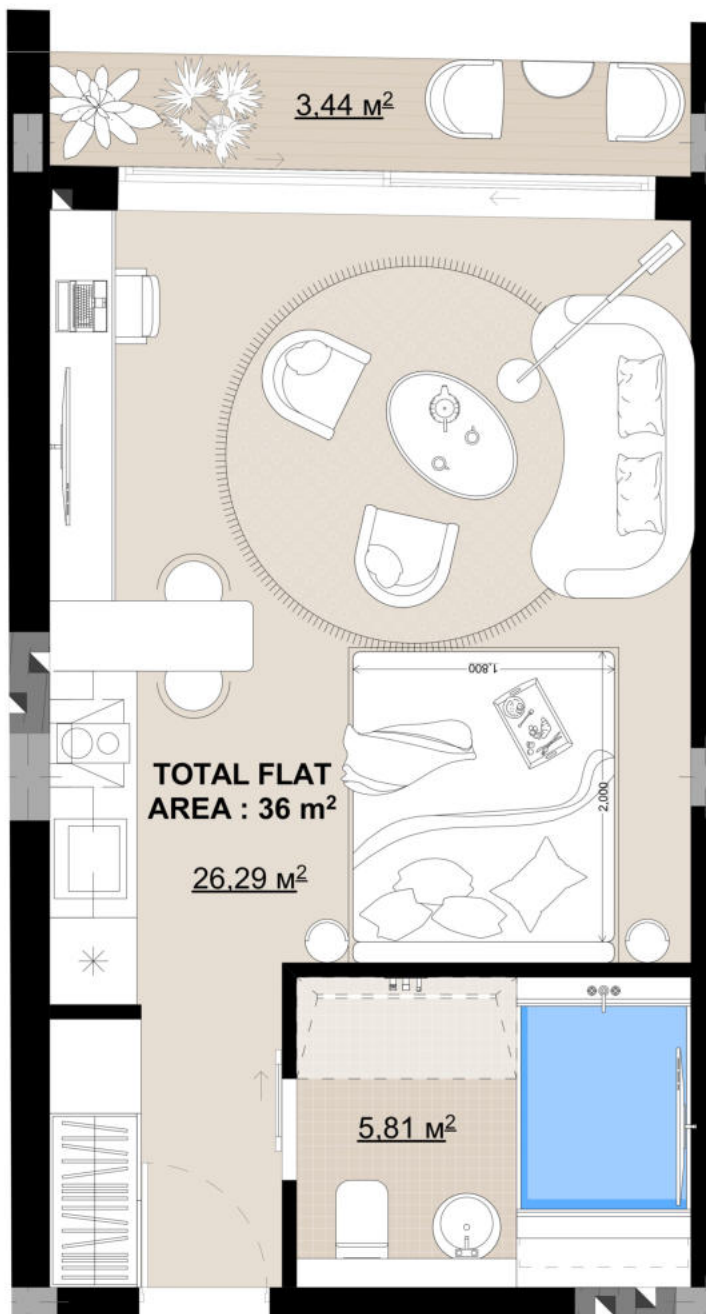

## SECTION "A"

SMART 142

FLAT AREA : 32,1 m<sup>2</sup>

TERRACE AREA : 3,44 m<sup>2</sup>

TOTAL FLAT AREA : 36 m<sup>2</sup>



6TH FLOOR

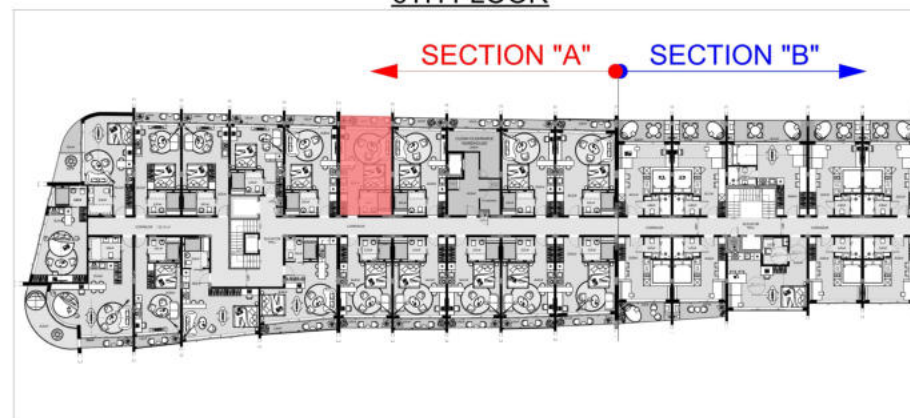

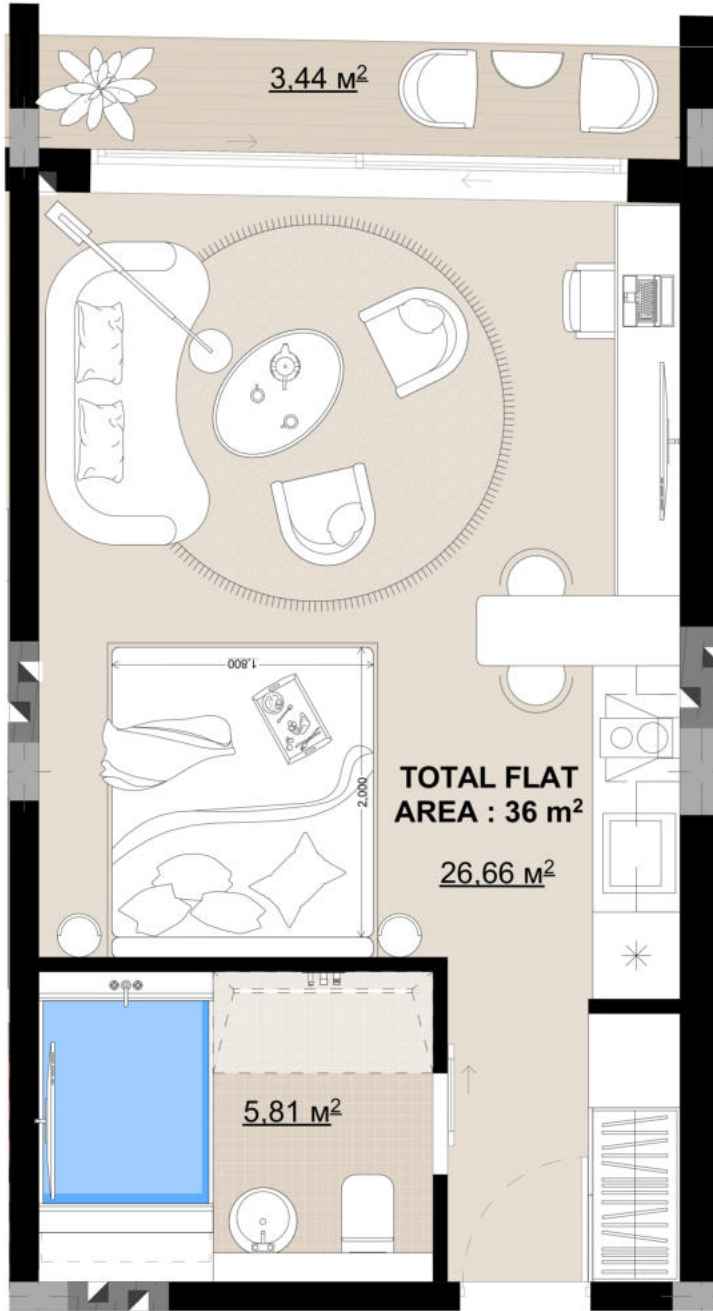

## SECTION "A"

SMART 141

FLAT AREA : 32,47 m<sup>2</sup>

TERRACE AREA : 3,44 m<sup>2</sup>

TOTAL FLAT AREA : 36 m<sup>2</sup>



6TH FLOOR

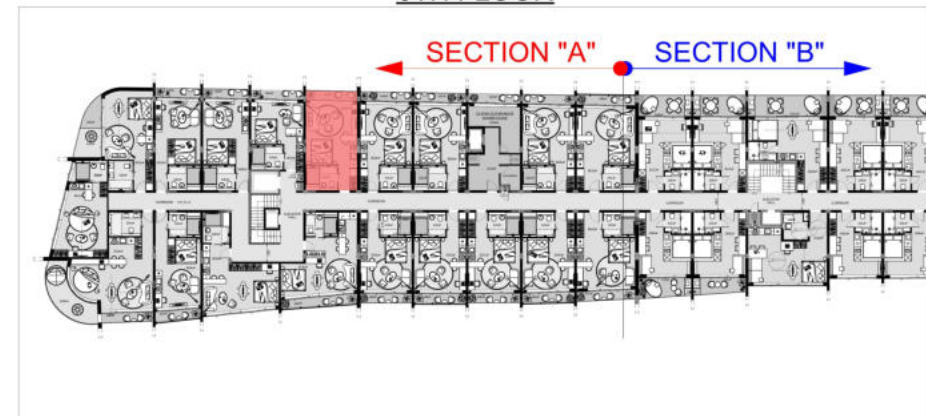

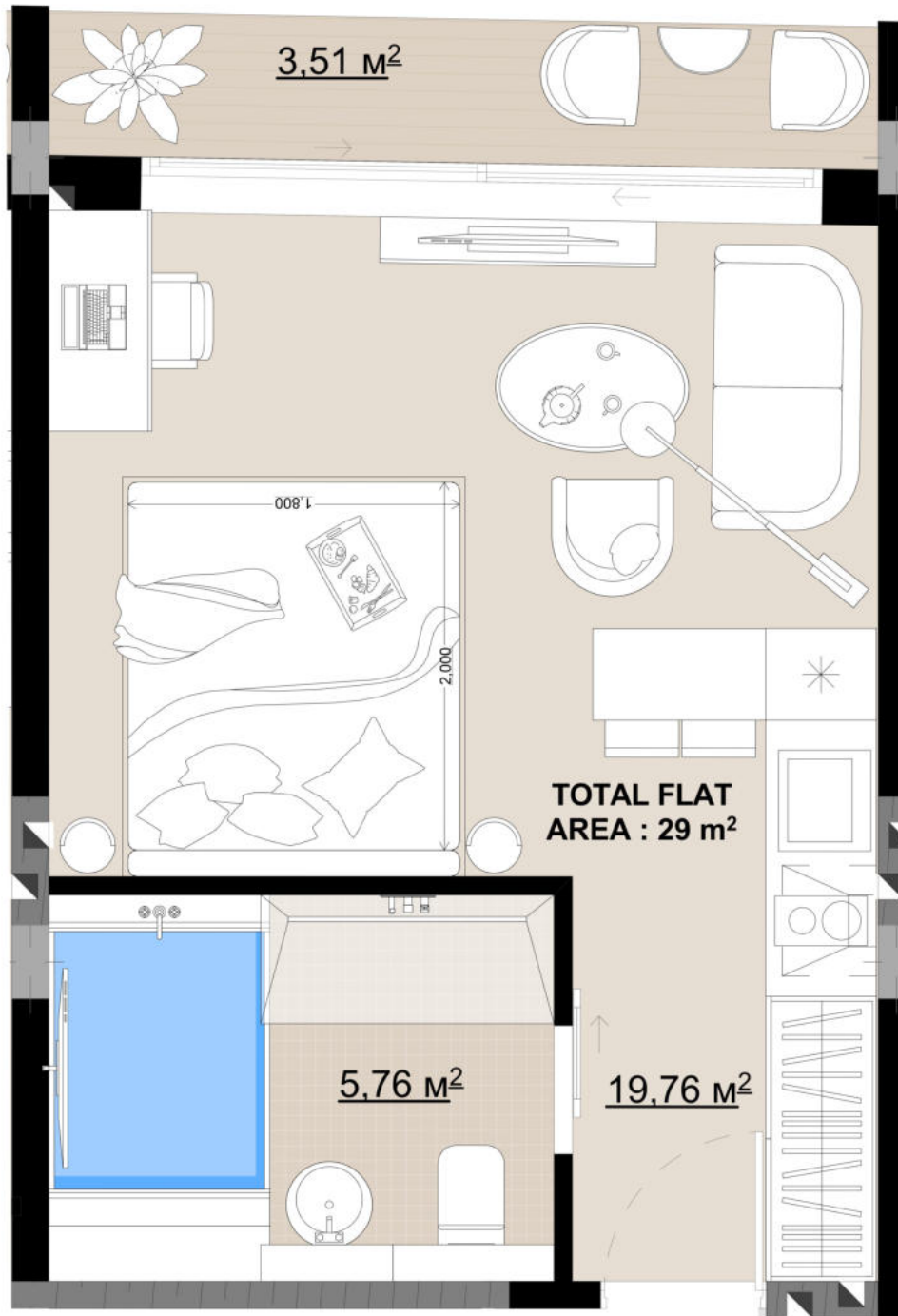

### SECTION "A"

SMART 140

FLAT AREA : 25.52 m<sup>2</sup>

TERRACE AREA : 3.51 m<sup>2</sup>

TOTAL FLAT AREA : 29 m<sup>2</sup>



6TH FLOOR

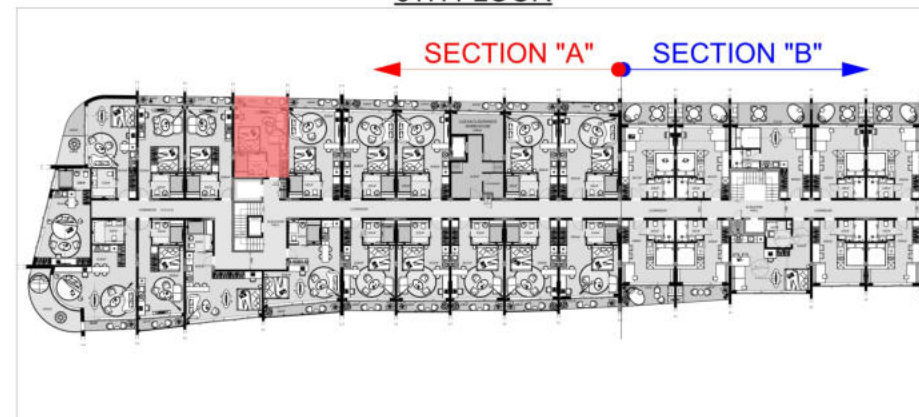

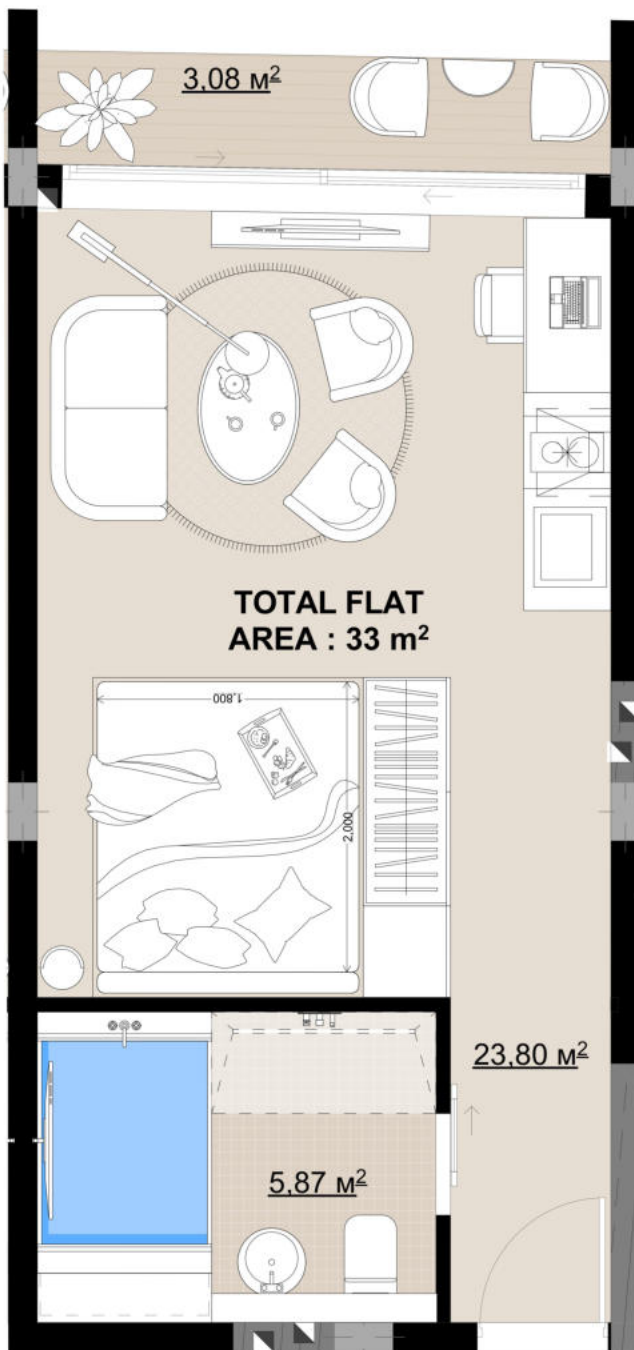

## SECTION "A"

SUITE 139

FLAT AREA : 29,67 m<sup>2</sup>

TERRACE AREA : 3,08 m<sup>2</sup>

TOTAL FLAT AREA : 33 m<sup>2</sup>



6TH FLOOR

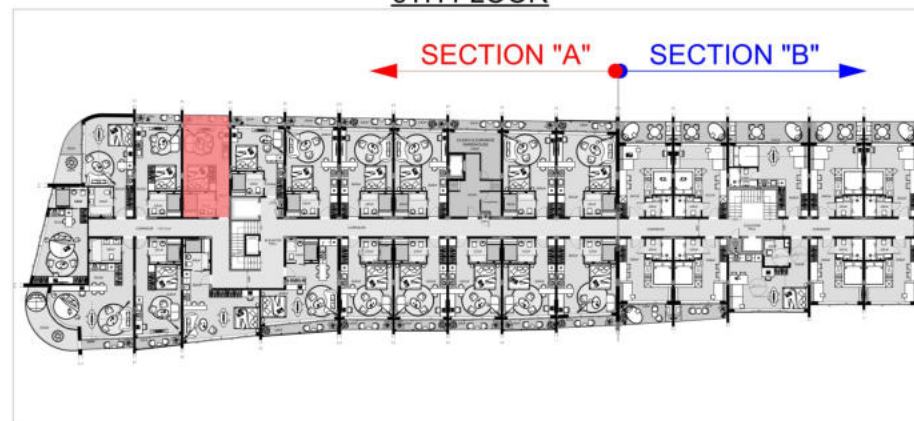

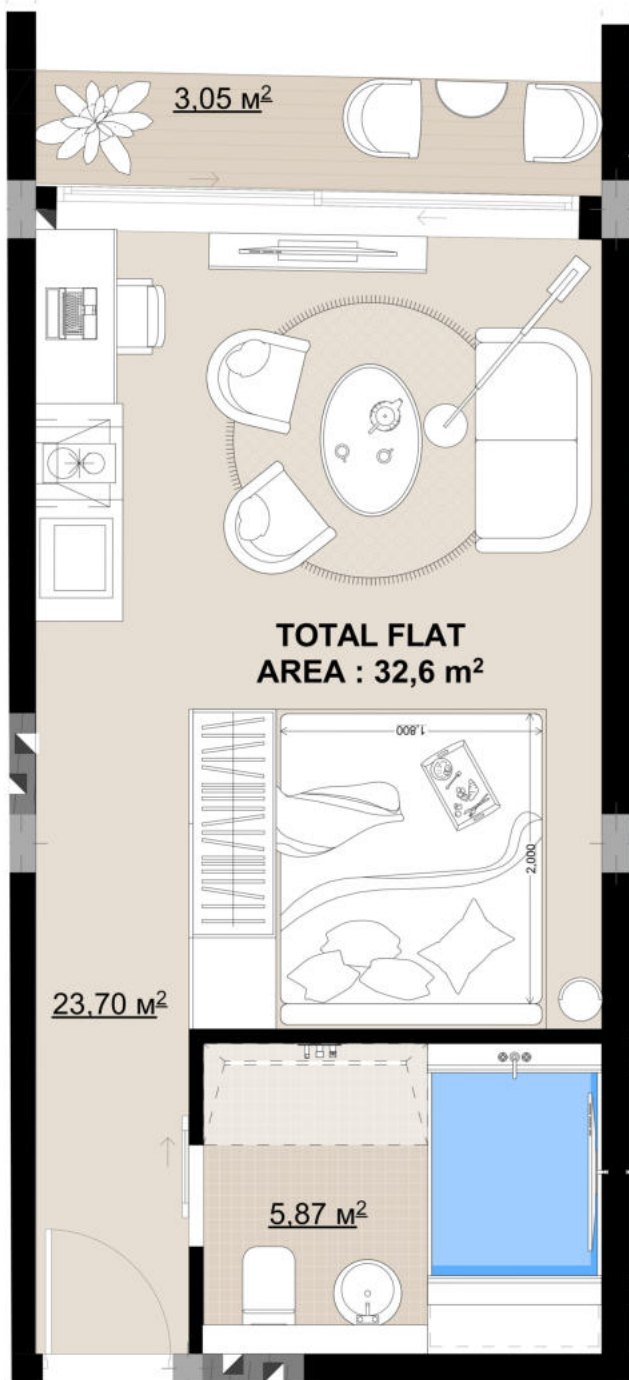

## SECTION "A"

SUITE 138

FLAT AREA : 29,57 m<sup>2</sup>

TERRACE AREA : 3.05 m<sup>2</sup>

TOTAL FLAT AREA : 32.6 m<sup>2</sup>



6TH FLOOR

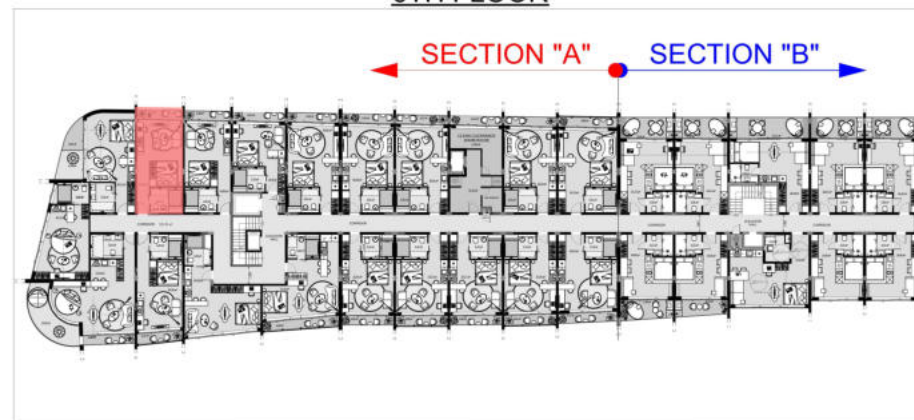

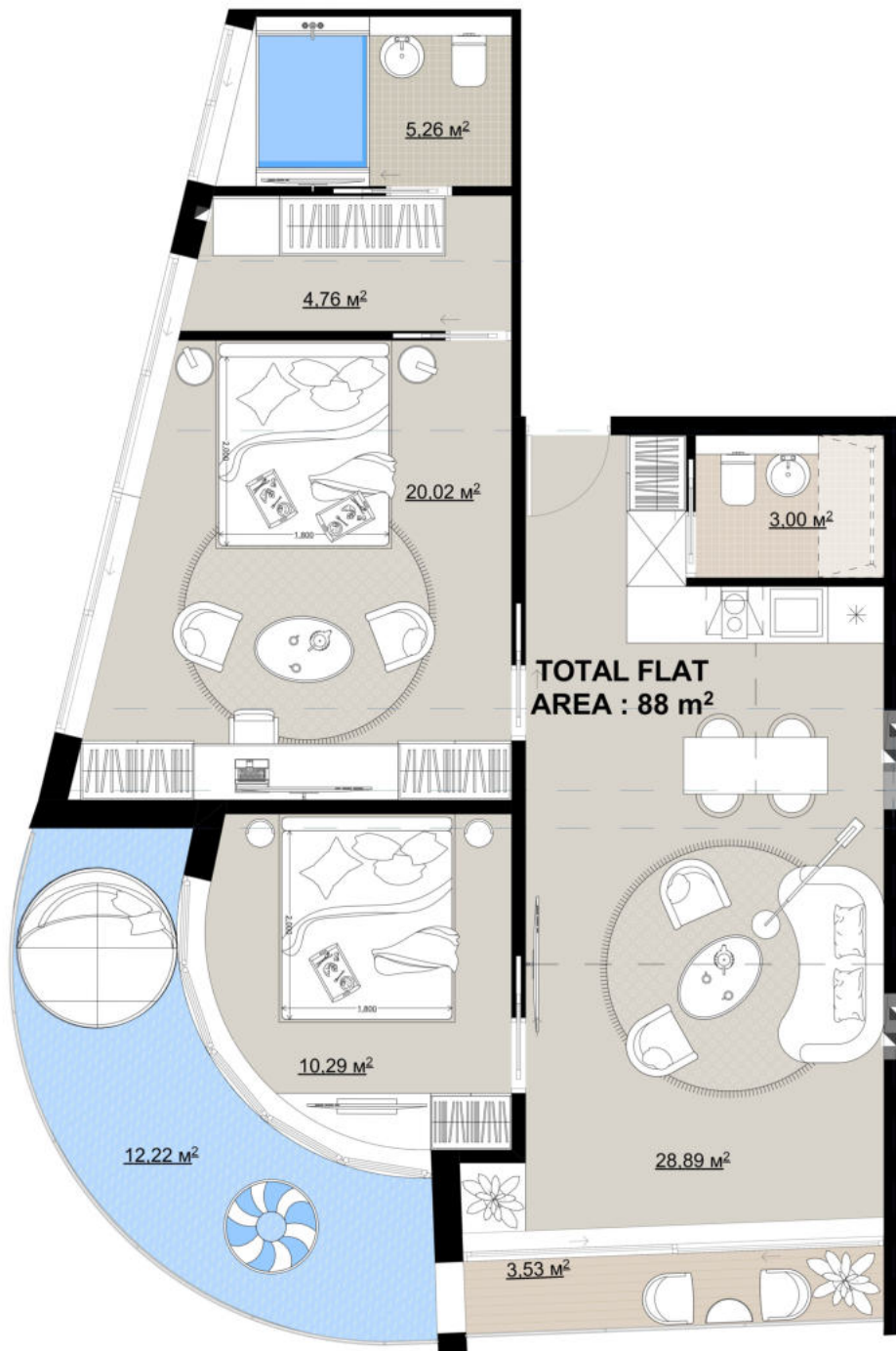

### SECTION "A"

OCEAN SUITE 163

FLAT AREA : 72,22 m<sup>2</sup>

TERRACE AREA : 15,75 m<sup>2</sup>

TOTAL FLAT AREA : 88 m<sup>2</sup>



6TH FLOOR

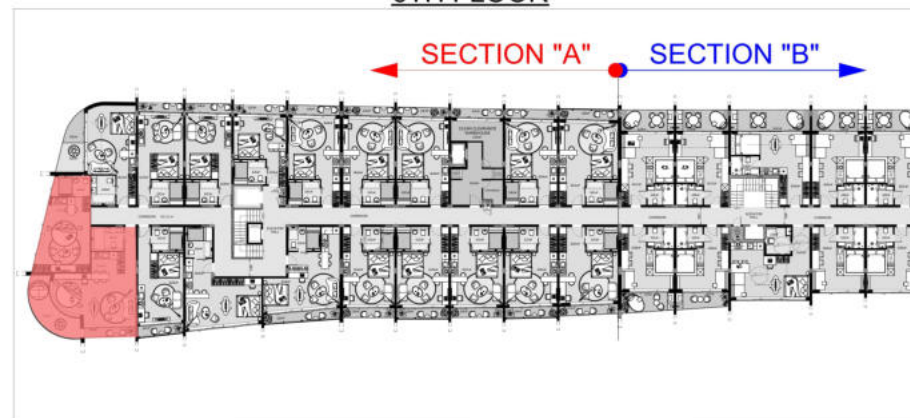

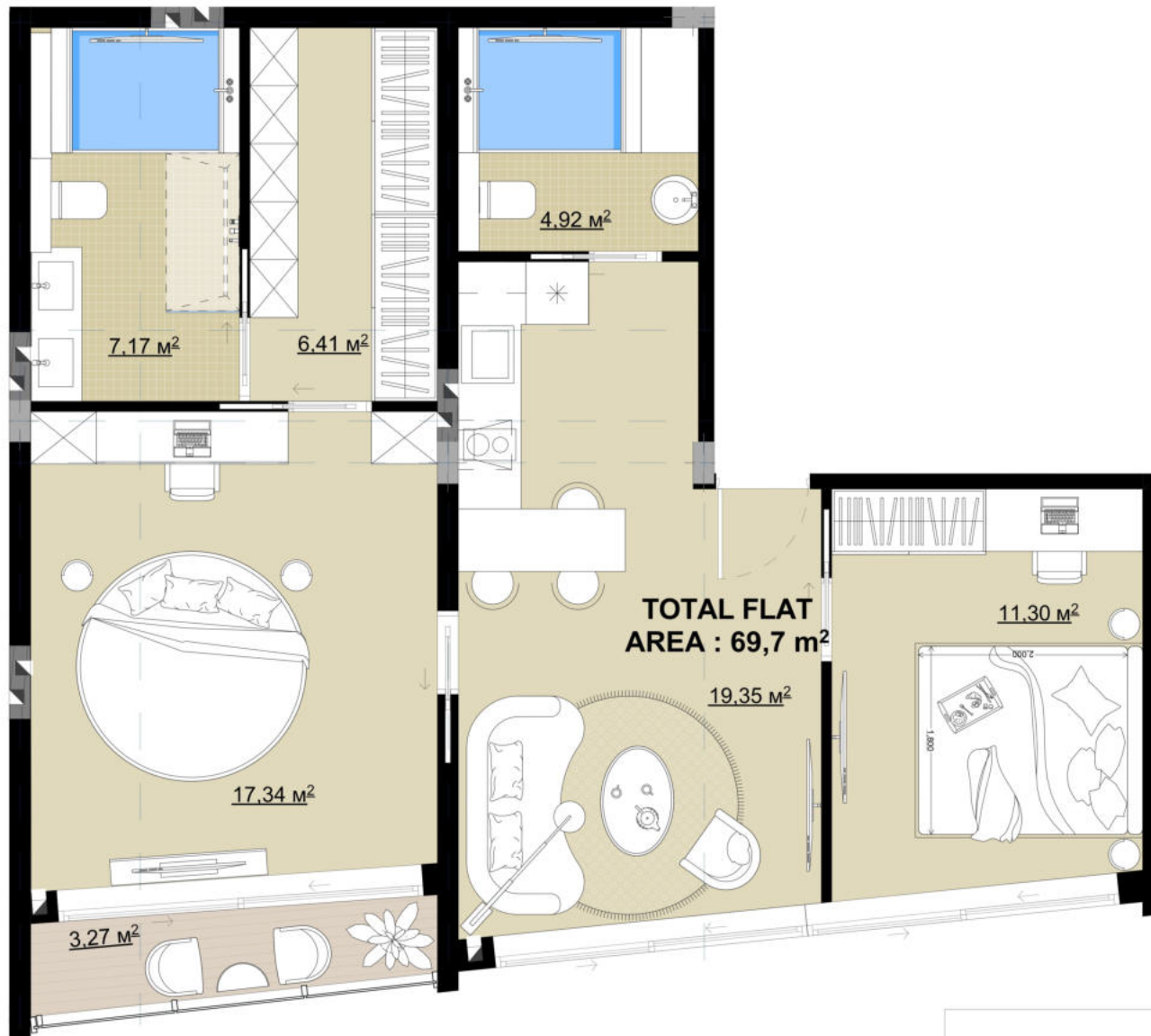

### SECTION "A"

OCEAN SUITE 162

FLAT AREA : 66,5 m<sup>2</sup>

TERRACE AREA : 3,27 m<sup>2</sup>

TOTAL FLAT AREA : 69,7 m<sup>2</sup>



6TH FLOOR

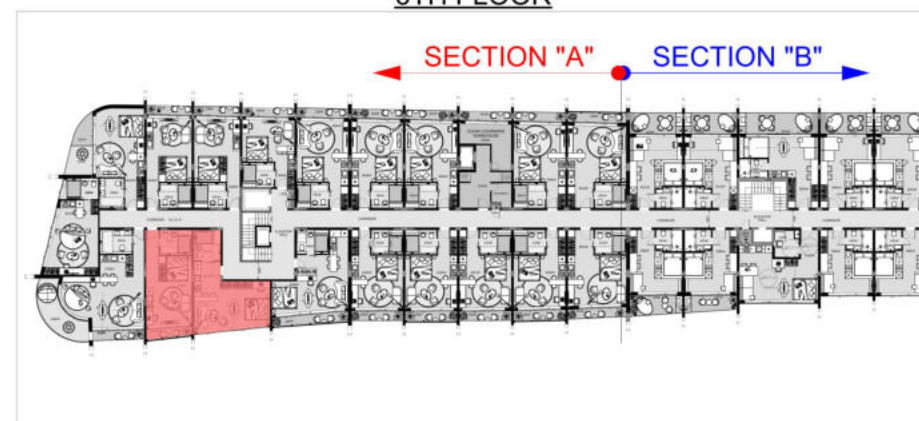

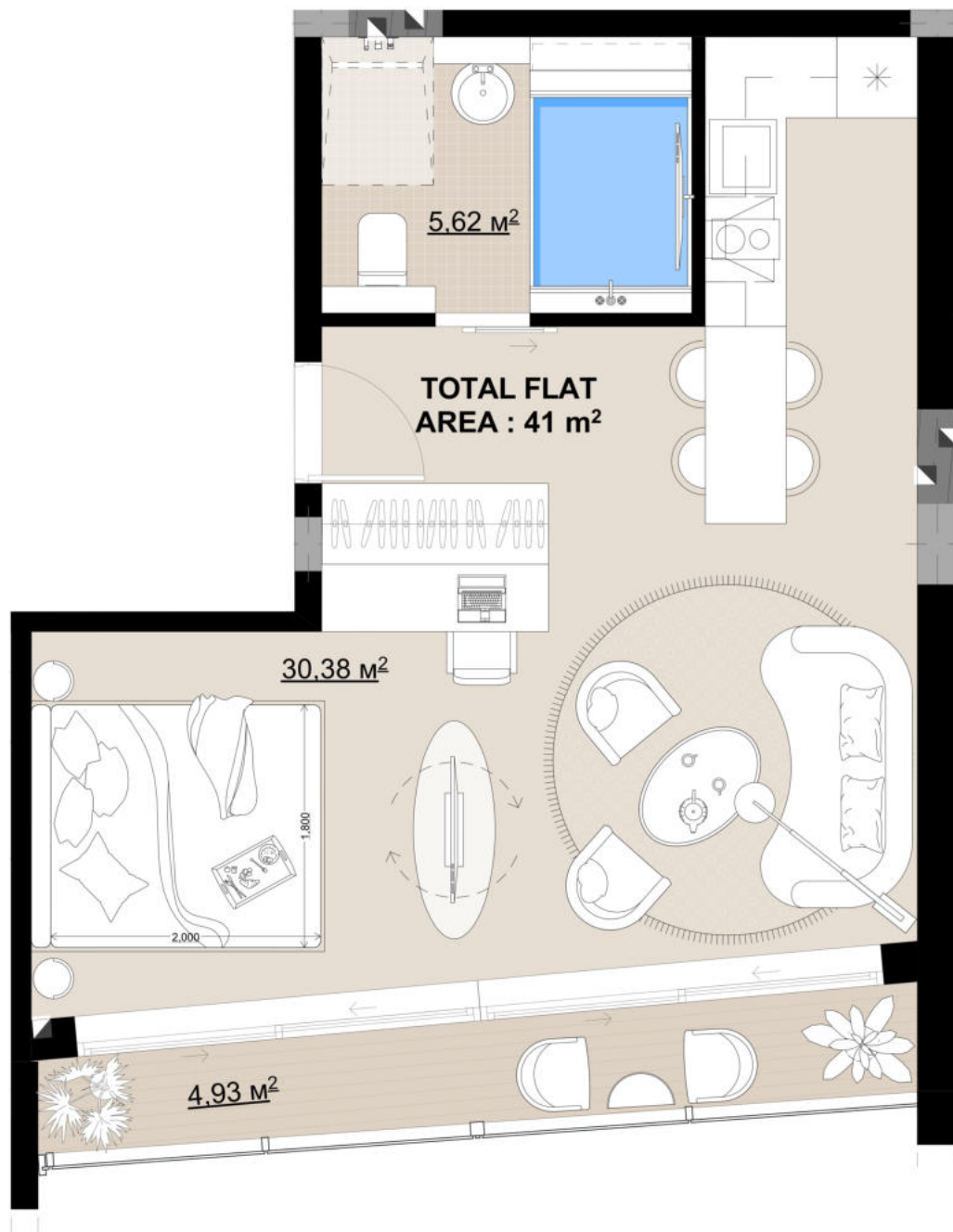

## SECTION "A"

OCEAN SUITE 161

FLAT AREA : 36 m<sup>2</sup>

TERRACE AREA : 4,93 m<sup>2</sup>

TOTAL FLAT AREA : 41 m<sup>2</sup>



6TH FLOOR

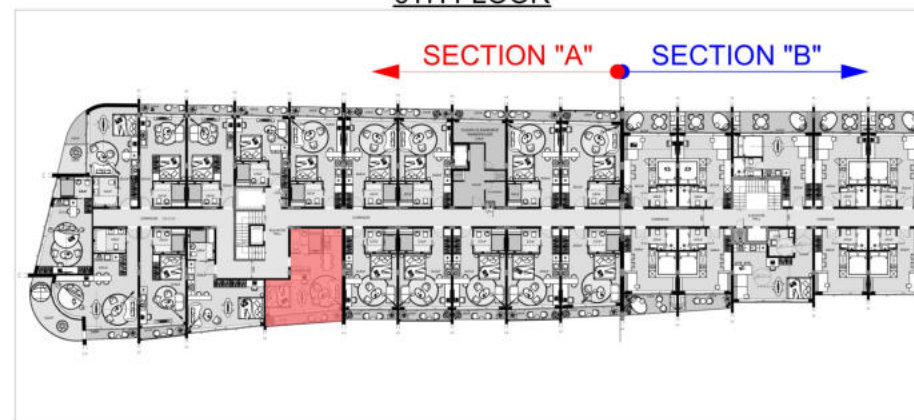

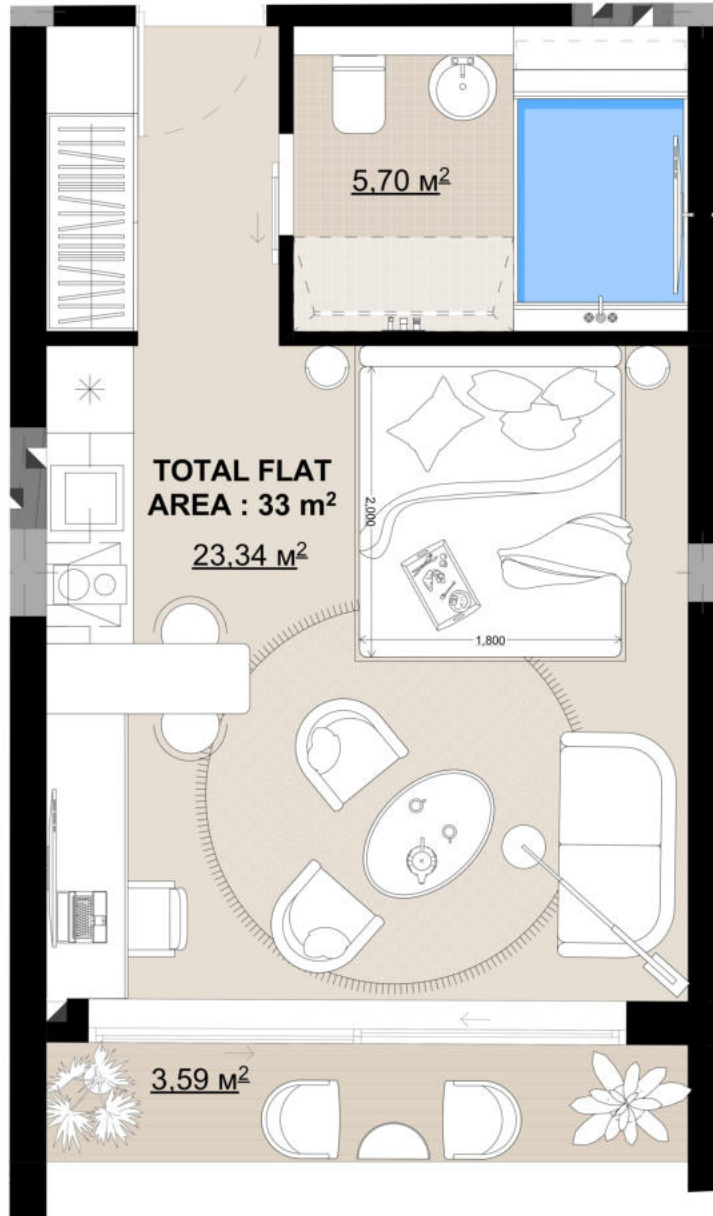

## SECTION "A"

OCEAN SUITE 160

FLAT AREA : 29,04 m<sup>2</sup>

TERRACE AREA : 3,59 m<sup>2</sup>

TOTAL FLAT AREA : 33 m<sup>2</sup>



6TH FLOOR

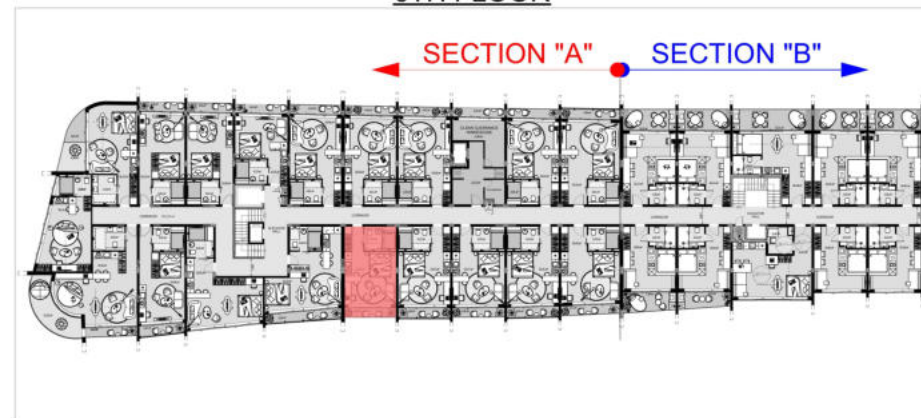

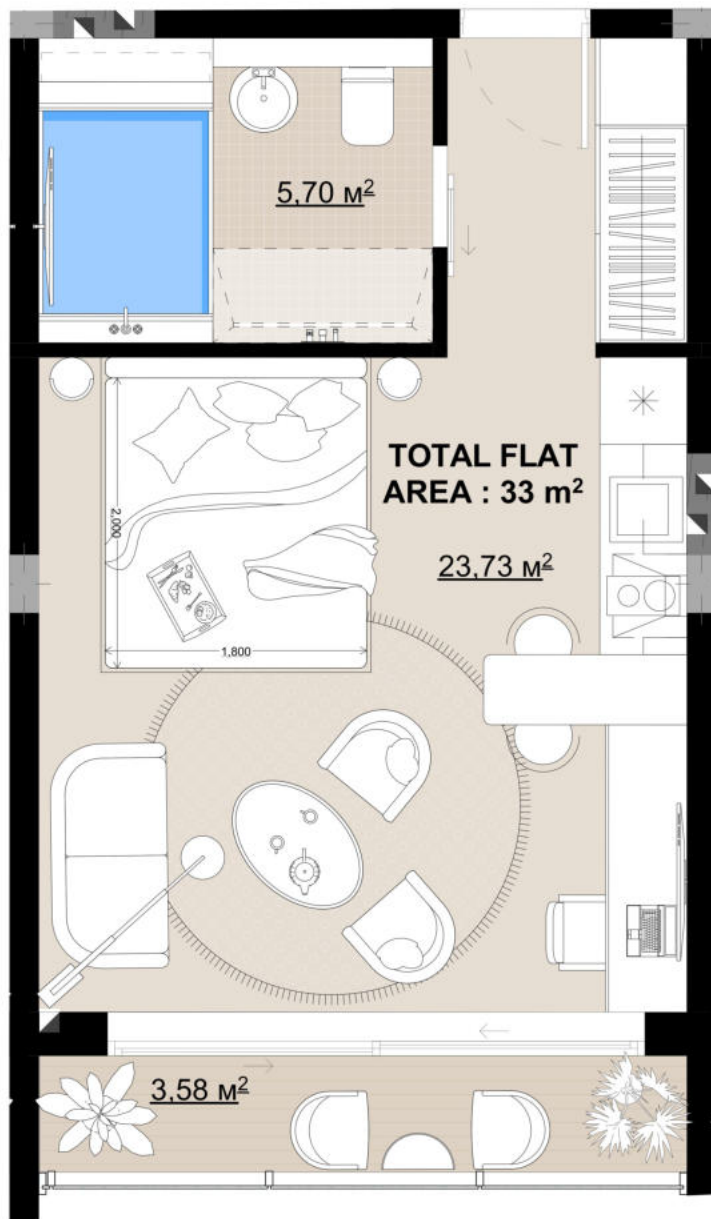

## SECTION "A"

OCEAN SUITE 159

FLAT AREA : 29,43 m<sup>2</sup>

TERRACE AREA : 3,58 m<sup>2</sup>

TOTAL FLAT AREA : 33 m<sup>2</sup>



6TH FLOOR

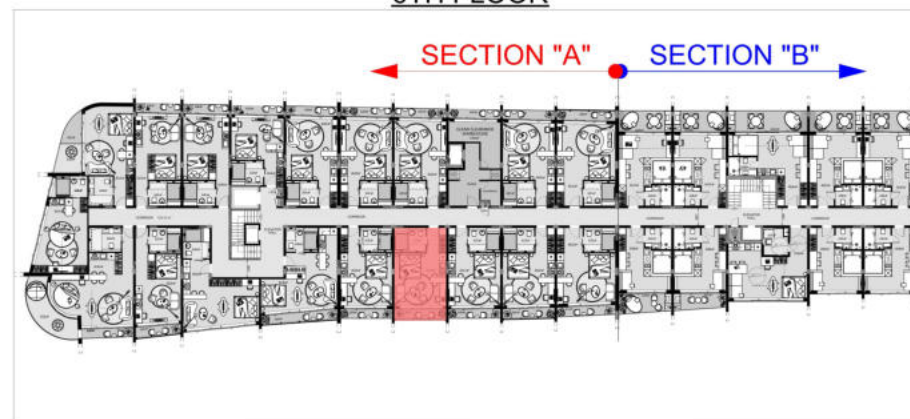

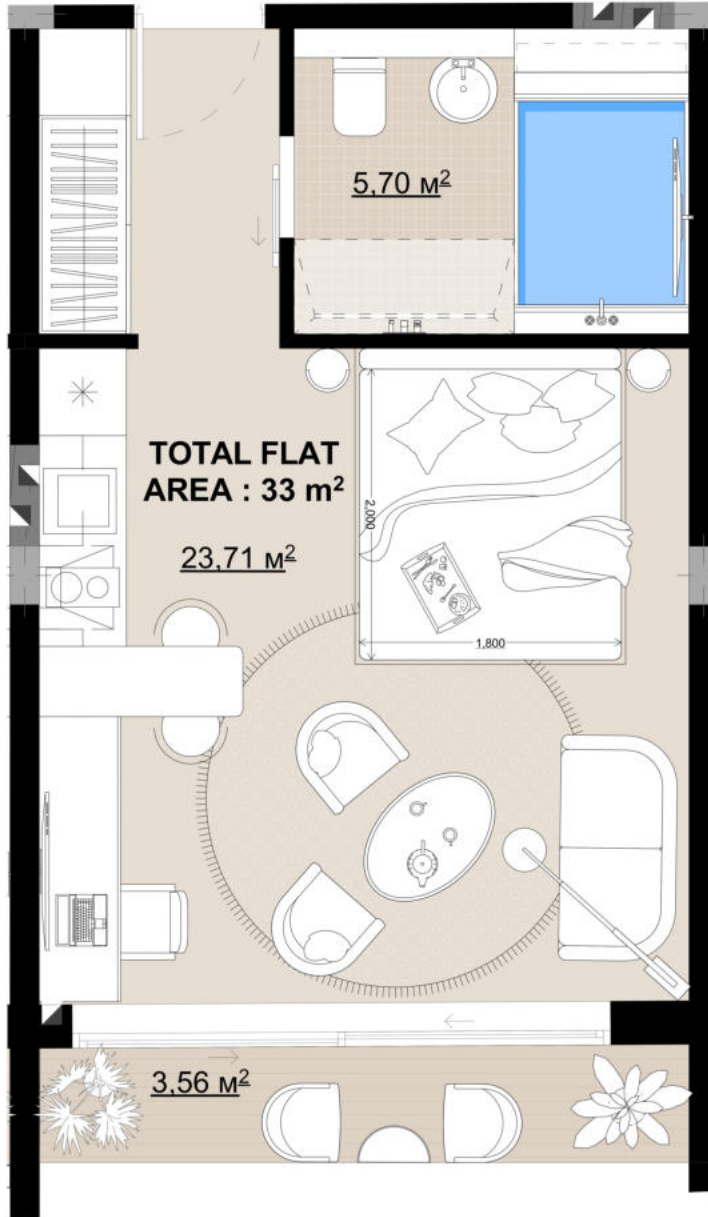

**SECTION "A"**

OCEAN SUITE 158

FLAT AREA : 29,41 m<sup>2</sup>

TERRACE AREA : 3,56 m<sup>2</sup>

TOTAL FLAT AREA : 33 m<sup>2</sup>



6TH FLOOR

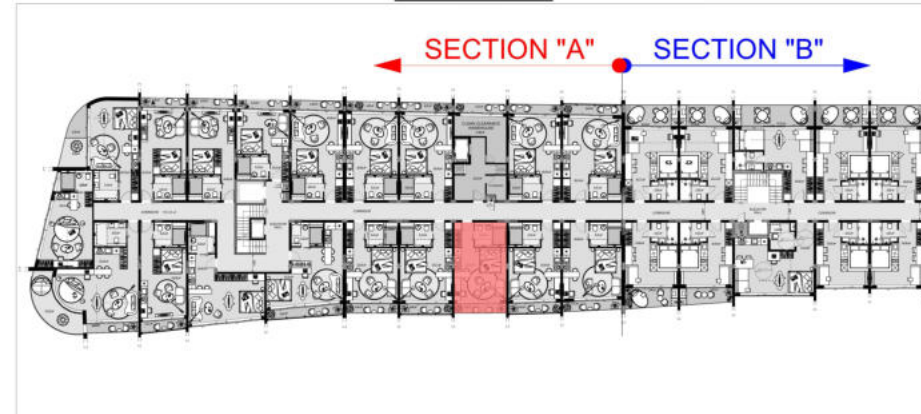

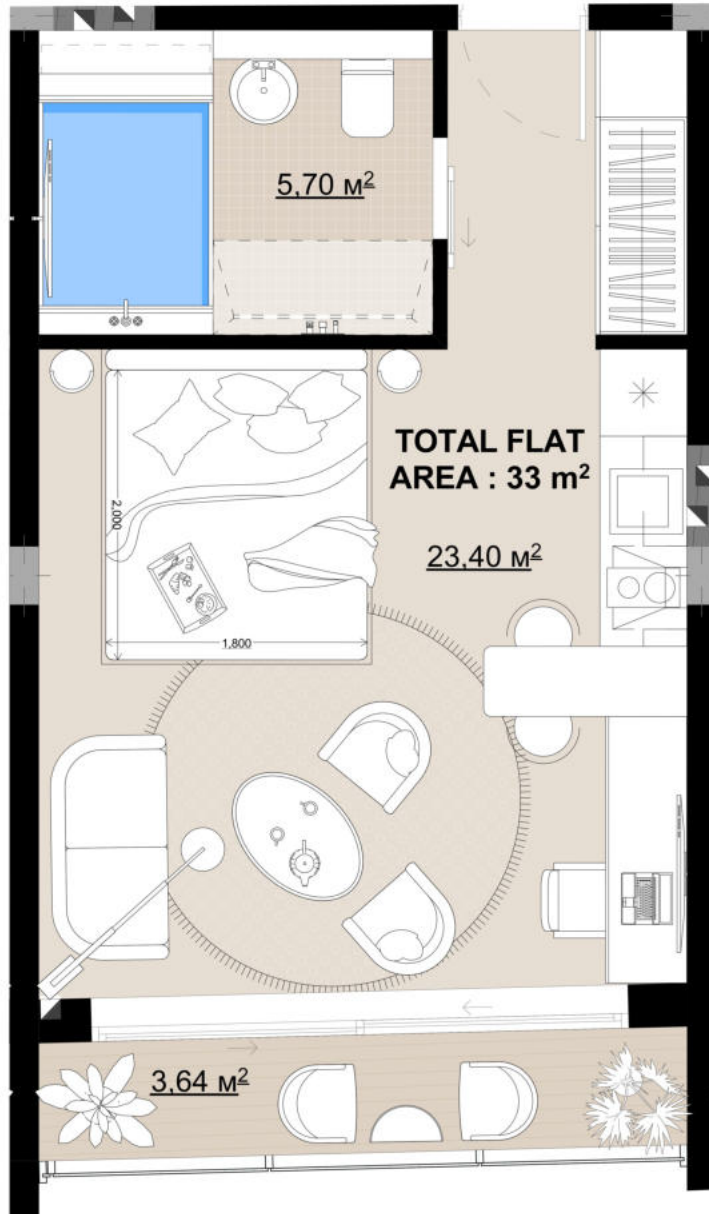

### SECTION "A"

OCEAN SUITE 157

FLAT AREA : 29,1 m<sup>2</sup>

TERRACE AREA : 3,64 m<sup>2</sup>

TOTAL FLAT AREA : 33 m<sup>2</sup>



6TH FLOOR

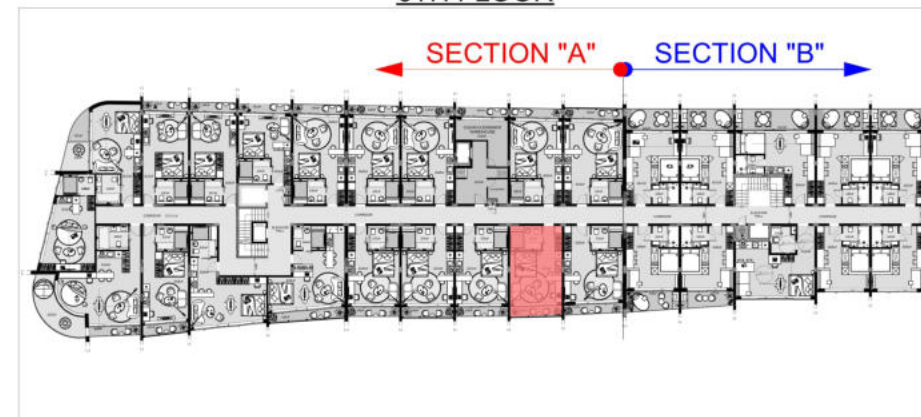

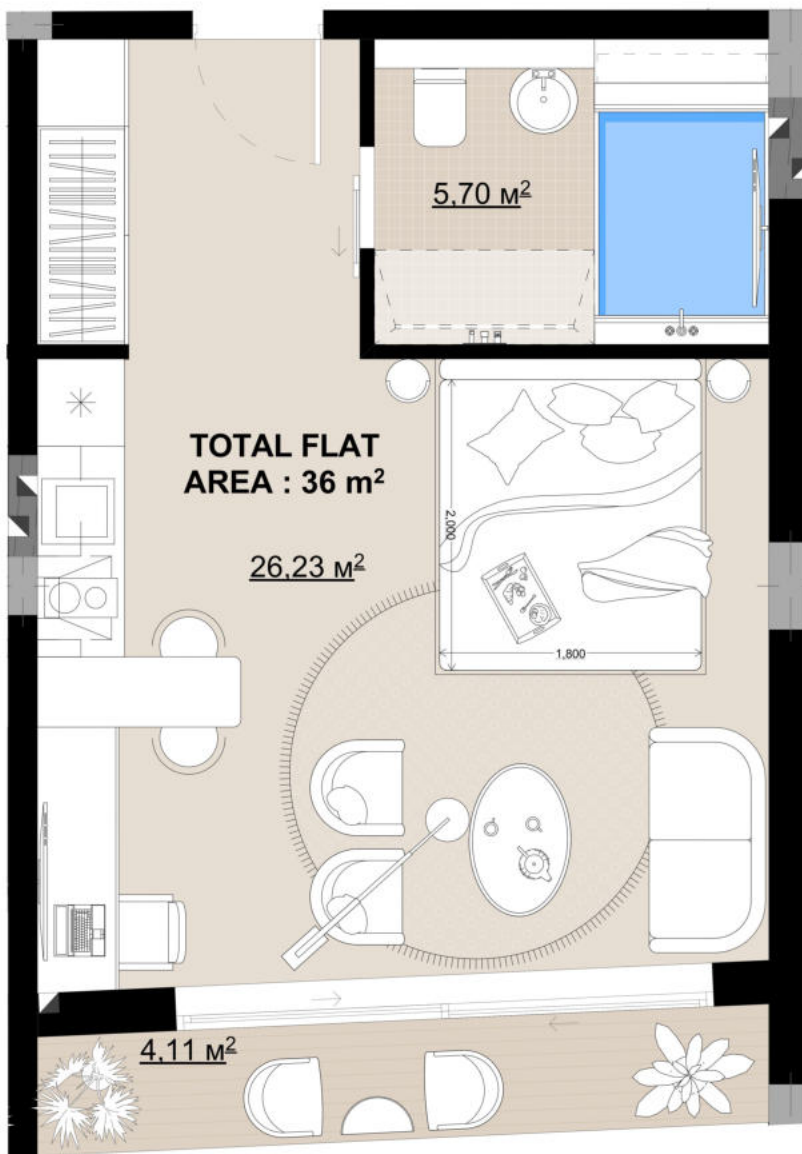

### SECTION "A"

OCEAN SUITE 156

FLAT AREA : 31.93 m<sup>2</sup>

TERRACE AREA : 4,11 m<sup>2</sup>

TOTAL FLAT AREA : 36 m<sup>2</sup>



6TH FLOOR

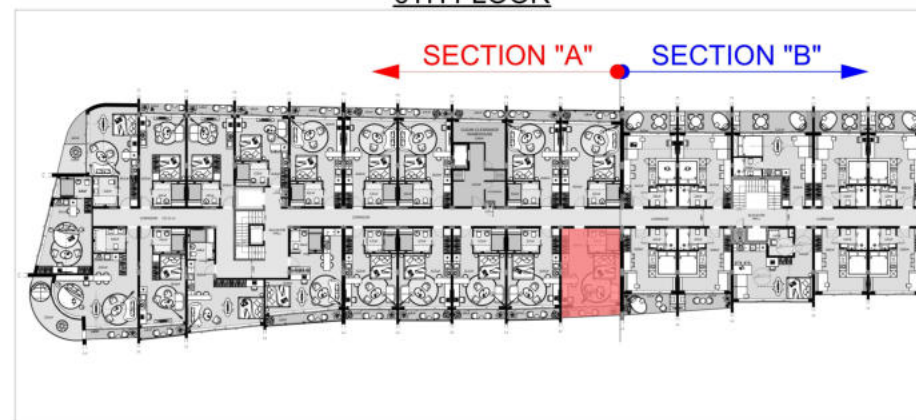

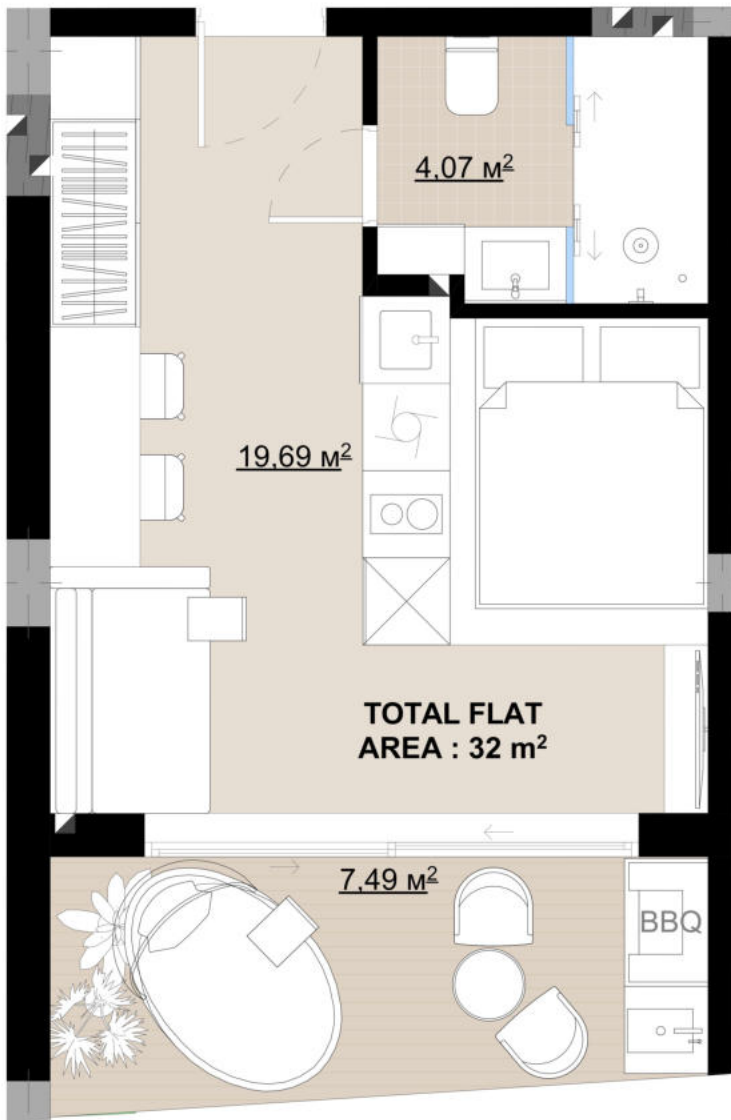

### SECTION "B"

SUITE 155

FLAT AREA : 23,68 m<sup>2</sup>

TERRACE AREA : 7,49 m<sup>2</sup>

TOTAL FLAT AREA : 32 m<sup>2</sup>



6TH FLOOR

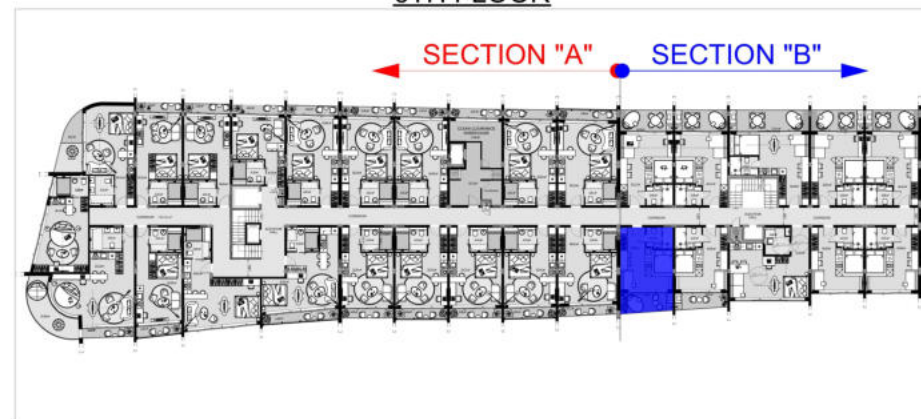

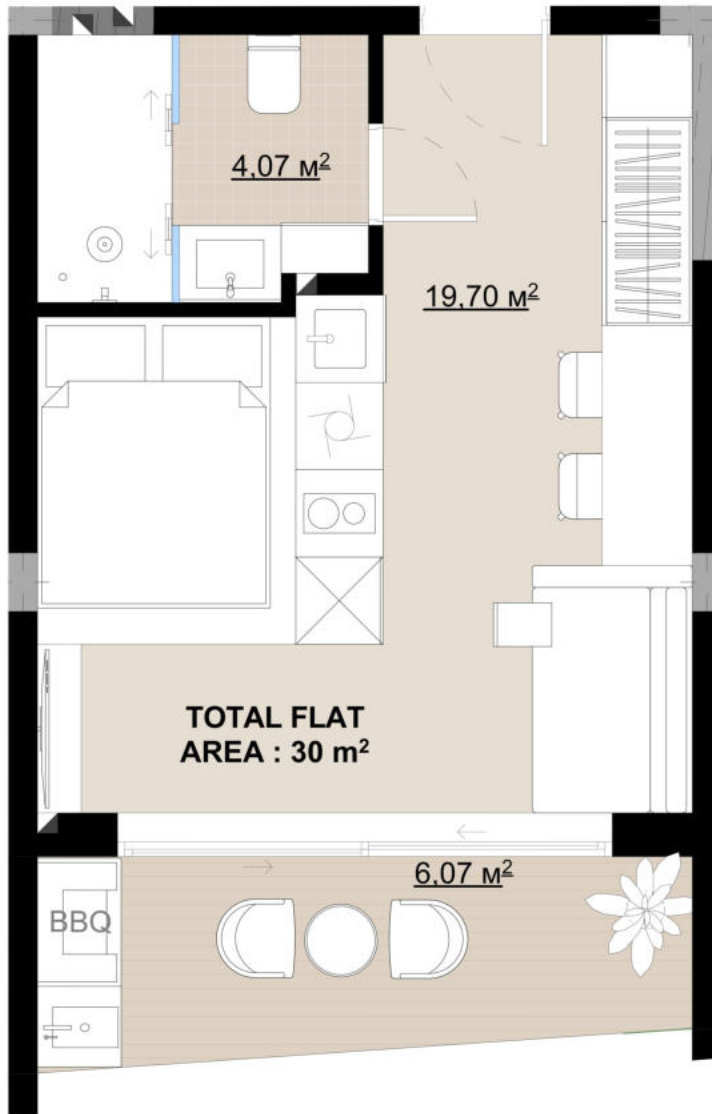

## SECTION "B"

SUITE 154

FLAT AREA : 23,5 m<sup>2</sup>

TERRACE AREA : 6,07 m<sup>2</sup>

TOTAL FLAT AREA : 30 m<sup>2</sup>



6TH FLOOR

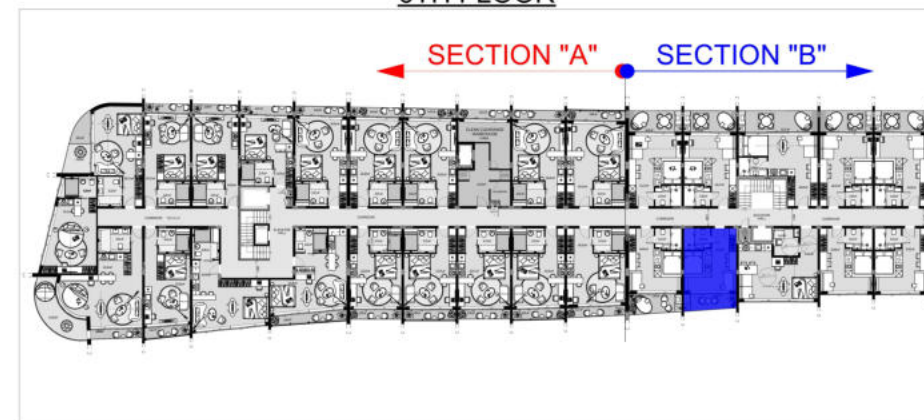



**SECTION "B"**

SUITE 153

FLAT AREA : 37 m<sup>2</sup>

TERRACE AREA : 0 m<sup>2</sup>

TOTAL FLAT AREA : 37 m<sup>2</sup>

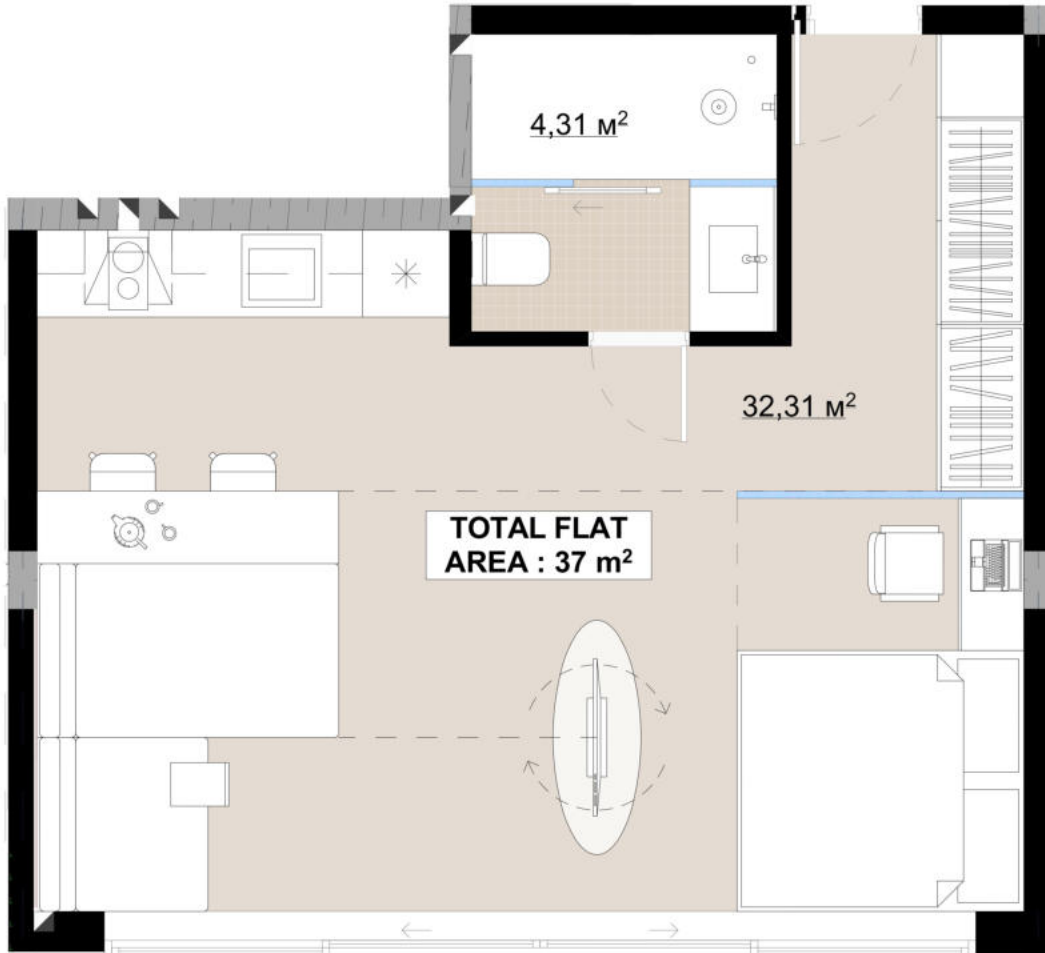

6TH FLOOR

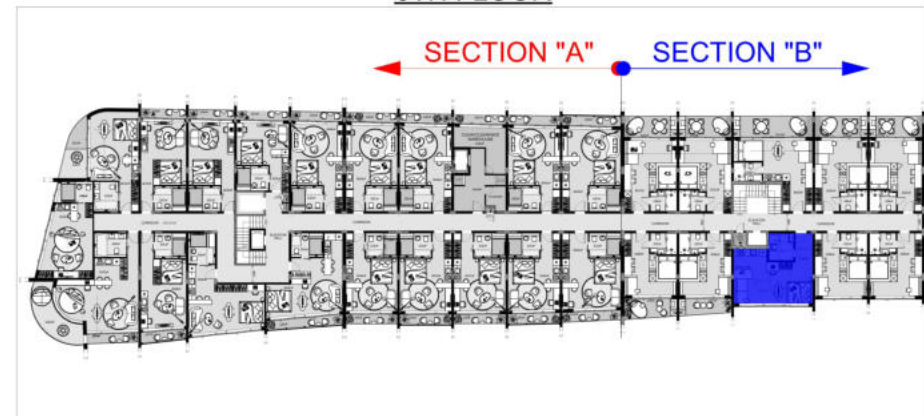

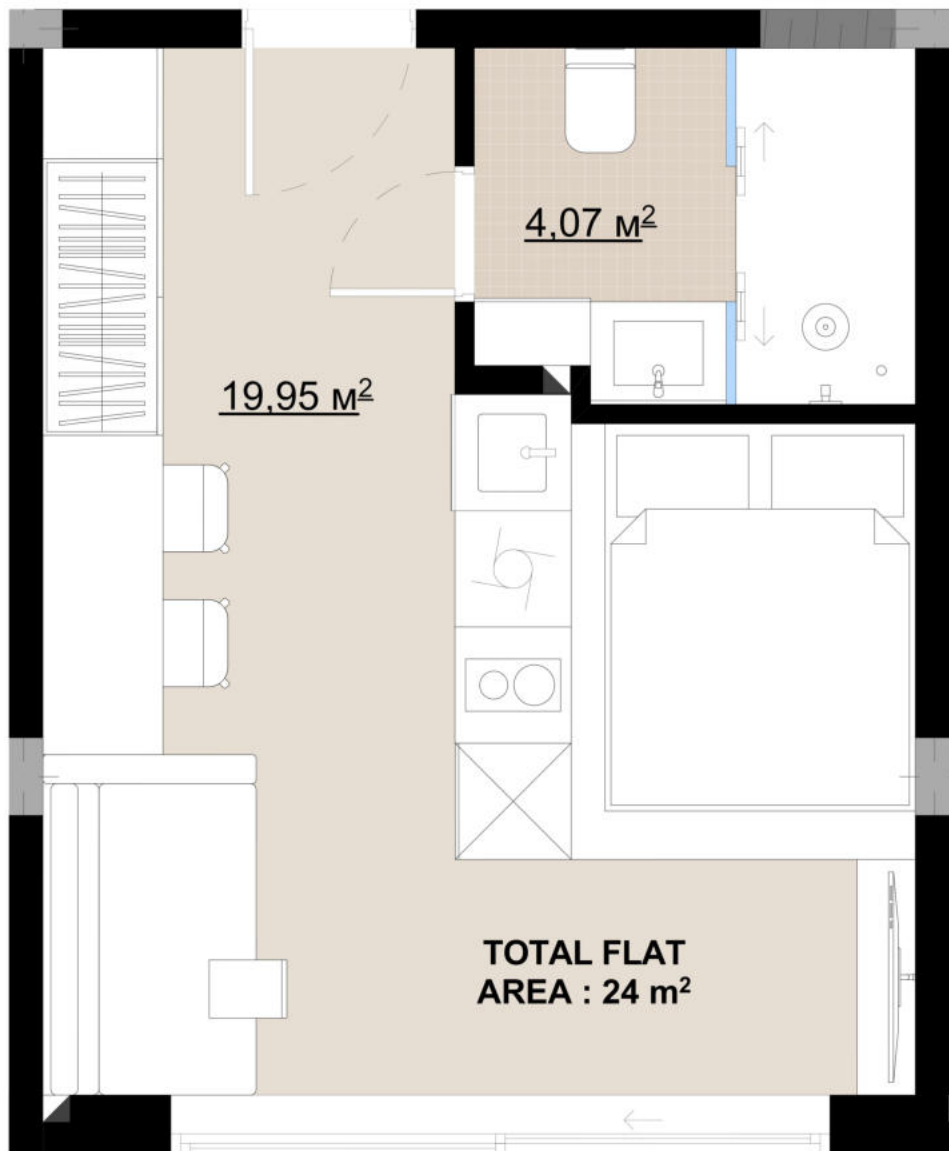

## SECTION "B"

SUITE 152

FLAT AREA : 24 m<sup>2</sup>

TERRACE AREA : 0 m<sup>2</sup>

TOTAL FLAT AREA : 24 m<sup>2</sup>



6TH FLOOR

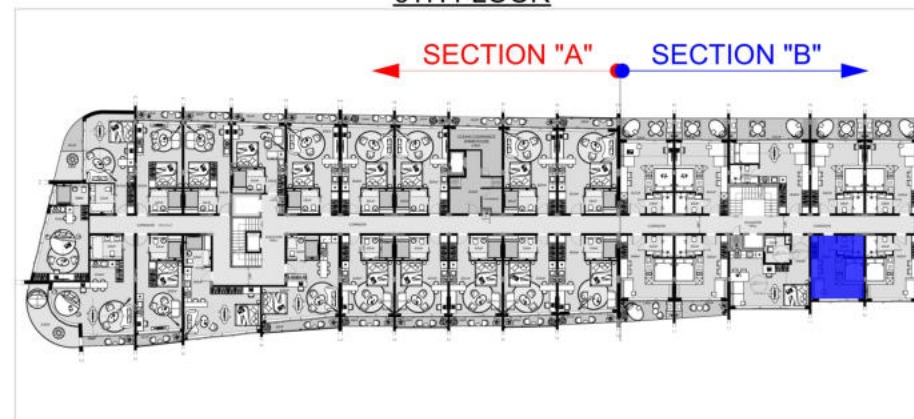

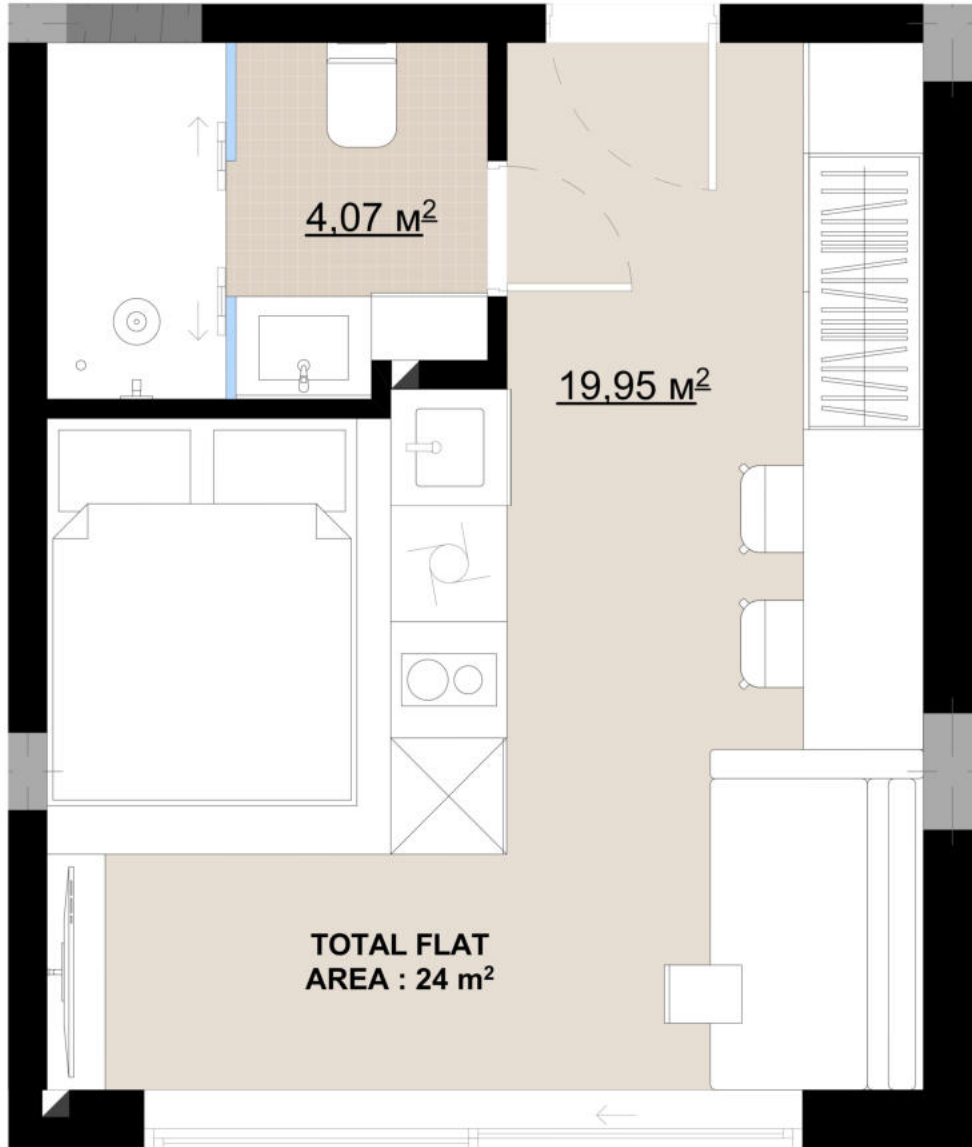

## SECTION "B"

SUITE 151

FLAT AREA : 24 m<sup>2</sup>

TERRACE AREA : 0 m<sup>2</sup>

TOTAL FLAT AREA : 24 m<sup>2</sup>



6TH FLOOR

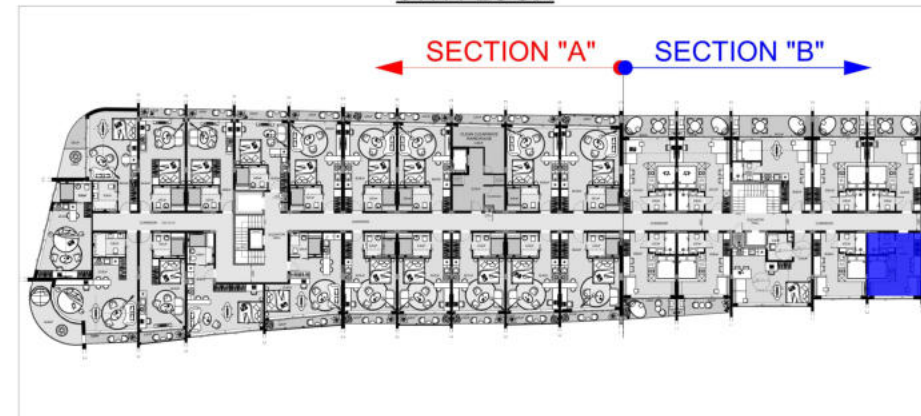

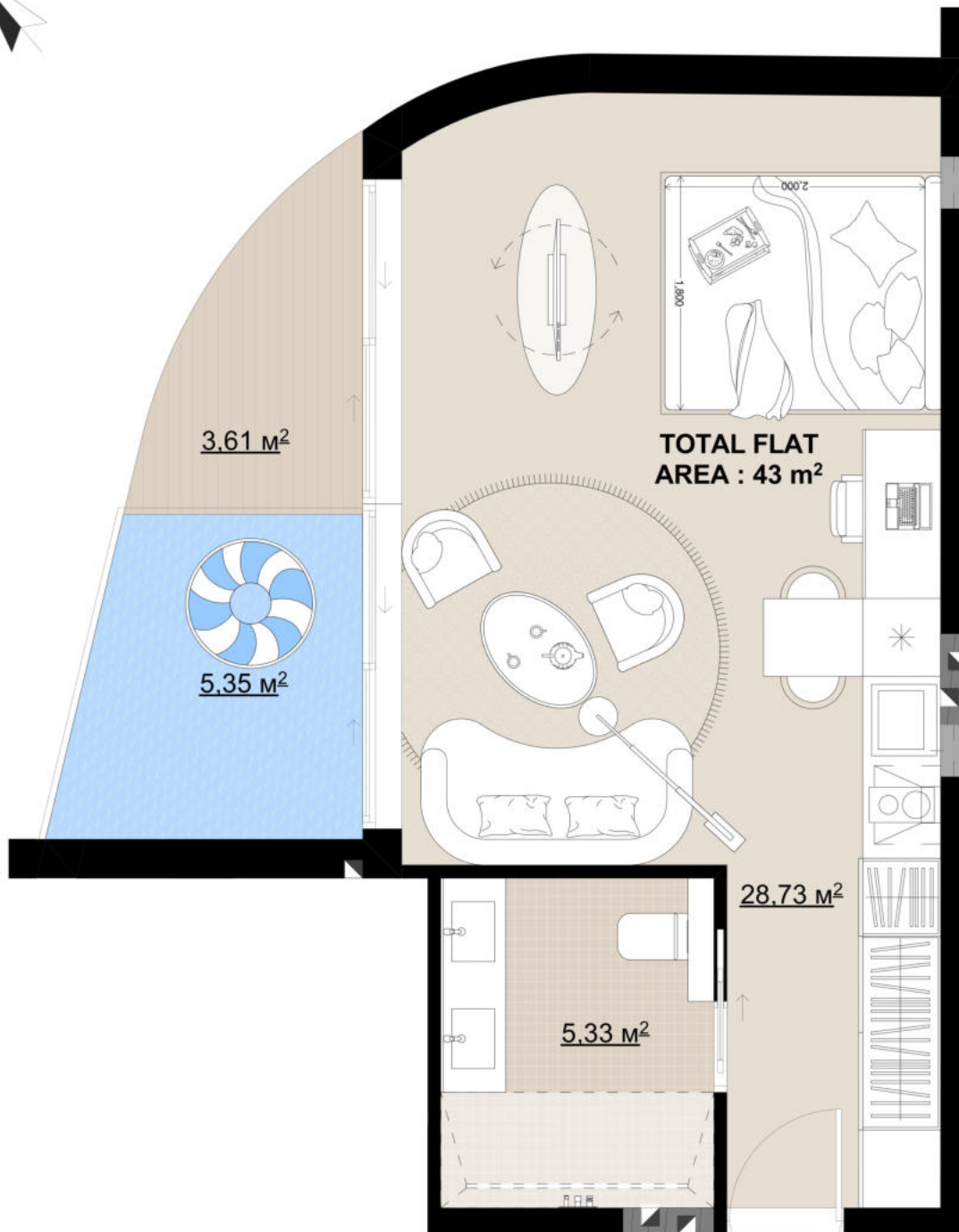

## SECTION "A"

JACIZZI SUITE 137

FLAT AREA : 34 m<sup>2</sup>

TERRACE AREA : 8,96 m<sup>2</sup>

TOTAL FLAT AREA : 43 m<sup>2</sup>



6TH FLOOR

